

# POPULAR COMMUNICATIONS

AUGUST 1990 \$2.95

\$3.95 CANADA

## Strange Signals Near The FM Band? (You Can Hear Them!)

*Also in this issue:*

- **Shortwave Mysteries**
- **Skip Scanning Is Bustin' All Over**
- **Those Stations Still Left From "The Left"**
- **Remembering Old Time Radio**



**Plus: Scanners, Car Phones, Satellites, Ham Radio & More!**

ICOM

IC-24AT  
IC-32AT

# WE CHALLENGE YOU TO A DUAL.

## ICOM'S DUAL BAND HANDHELDS

ICOM's IC-24AT and IC-32AT call you to action with the most feature packed, power packed dual band handhelds available. Whether you prefer the convenience of a mini-handheld or the grasp of a full-size handheld, ICOM has the dual-bander fit for you.

The IC-24AT mini-handheld and the IC-32AT give you full operation on the 2-meter and 440MHz amateur bands. Outstanding Performance!

**POWER PACKED HANDHELDS.**

The IC-24AT provides up to 5 watts on 2-meters and 440MHz with a 12V battery while the IC-32AT is 5 1/2 watts on 2-meters and 5 watts on 440MHz.

**PLENTY OF MEMORIES.** Store any frequency, Tx offset and subaudible tone in any memory. Total flexibility to meet your needs.

**PROGRAMMABLE SCANNING.** Both units scan band and memories plus offer easy memory lockout and instant memory recall.

**PRIORITY WATCH.** Monitor the call channel, a memory channel or all memory channels every five seconds while operating!

**ADDITIONAL FEATURES INCLUDE:** Battery saver, all subaudible tones, multi-function LCD readout,



dial selectability and LTMF pad for memory channel auto-catching. The compact light-weight IC-24AT also features a 24 hour clock with timer, and an autodialer. Access to multi-digit phone numbers at the touch of a button.

**ACCESSORIES:** The IC-24AT uses accessories from the "S" Series handhelds while the IC-32AT is compatible with all IC-24AT/02AT accessories. An optional UT-40 beeper silently monitors a busy channel for your calls. When the preprogrammed subaudible tone is received, the unit beeps and the LCD flashes.

The dual is over, ICOM's IC-24AT mini-dual bander and IC-32AT full-size-dual bander give you maximum performance in the package best suited for your needs. Check your local ICOM dealer for the finest dual banders available today. The ICOM IC-24AT and IC-32AT.

ICOM  
First in Communications.



# The ICOM EXPERTS

Minutes From  
Washington, D.C.

## CLASSIC



### R71A .1-30 MHz

- World Class HF Receiver
- All Mode AM, CW, SSB, RTTY, FM (Opt)
- Keyboard And Memory Frequency Entry
- 32 Programmable Memory Channels
- Optional Filters, Voice, 12VDC, Computer Input
- Many EEB Options Listed In Our 1990 Catalog
- 117/220/234 VAC 13.8 VDC (Opt)
- 11.25W x 4.44 x 10.9D (Inch) 16.5 Lbs

List \$999

**EEB Discount Price \$849.95 + UPS**

Get The Details From  
Our FREE 1990 Catalog.

## CLASSIC



### R7000 25-2000 MHz

- VHF/UHF Classic Nothing Like It Under \$4000
- Triple Conversion Eliminates Images
- Tuning Steps .1,1,5,10,12.5,25 MHz Increments
- 99 Programmable Memory Channels
- Sensitivity Better Than .5µV (12dB SINAD) FMN
- Multimode AM, FM, FMN, FMW, CW/SSB
- Many EEB Options Listed In Our 1990 Catalog
- 117/220/234VAC 13.8VDC (Opt)
- 11.25W x 4.4H x 10.9D (Inch) 17.5 Lbs

List \$1199.00

**EEB Discount Price 1019.00 + UPS**

## CLASSIC



### R9000 .1-2000 MHz

- Never Has So Much Been Offered In One Receiver
- Covers Everything VLF (100 kHz) To Super UHF 2 GHz
- Multimode AM, FM, FMN, FMW, CW, SSB, RTTY
- 1000 Programmable Memory Channels
- DDS (Direct Digital Synthesizer) Tuning
- CRT, Spectrum Analyzer, Multi Screen Readout
- Power 100-120VAC 220-240 12VDC(Opt)
- EEB Optional Power Supply And Filters
- 16.7W x 5.9H x 14.4D (Inch) 44.1 Lbs

List \$5495.00

Call

**EEB Discount Price ~~5295.00~~ + UPS**

**FREE DETAIL LITERATURE ON ALL ICOM PRODUCTS  
CALL 1-800-999-9877**

## NEW



### Magnavox 3805 Digital

- SW 3.2-7.3/9.5-21.75 MHz
- FM/FM Stereo/AM
- PLL Synthesized
- 20 Memories 5 AM 5 FM 10SW
- Clock 12/24 Hour Alarm
- Push Button Memory Recall
- 4AA Or Optional AC Adapter

**Unbelievable \$129.95 + UPS**

## NEW



### SONY ICF SW 7600

- SW All Bands .1-30 MHz
- FM Stereo With Headphones (Incl)
- 10 Memories & Clock Timer Alarm
- CW SSB (USB, LSB)
- Keyboard Frequency Entry
- Complete System Including Ext Ant, Headset, Book, AC Adapter
- New Replacement For ICF-2003

List \$259.95 **EEB \$219.95**

## CLOSEOUT



### Panasonic RFB20

- LW/MW/FM/6SW Bands
- Easy Analog Tuning
- Excellent Audio For Size
- 2 Year Panasonic Warranty
- Carry Case & Earphone (Incl)
- 3AA DC Optional AC Adapter

List \$149.95 **46% OFF**

**EEB \$79.95** While They Last



**ELECTRONIC EQUIPMENT BANK**  
323 MILL STREET, N.E.  
VIENNA, VA 22180

**ORDERS: 800-368-3270**

**LOCAL TECH: 703-938-3350**

**FAX: 703-938-6911**

- PRICES SUBJECT TO CHANGE
- PRICES DO NOT INCLUDE FREIGHT
- SORRY, NO CODs
- RETURNS SUBJECT TO 15% RESTOCK FEE

# POPULAR COMMUNICATIONS

AUGUST 1990

VOLUME 8, NUMBER 12



22



32

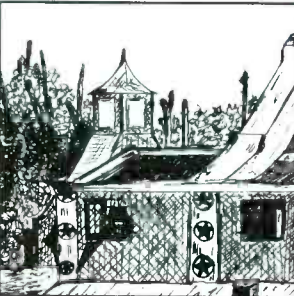

50



71

## FEATURES

- Still Left** 8  
How The World's Changing Political Climate Affects Your Listening. *By Gerry Dexter*
- Eerie Shortwave Mysteries** 12  
Strange Signals From Unknown Sources Bombard Your Receiver. *By Harry Helms, AA6FW*
- Skip Is Bustin' Out All Over** 16  
Scanning From 25 MHz To Over 1000 MHz Can Reward You With DX In August. *By Chuck Robertson*
- POP'COMM Reviews: Software Systems Consulting's PC SWL Program** 20  
*By Don Allen*
- Radio Remembered** 22  
Wandering Through The Pages Of History. *By Alice Brannigan*
- Those Strange Signals Above The FM Band** 29  
Ten MHz Of New VHF Signals 108-118 MHz. *By Ralph C. Craig*
- DX'ing Space From Easter Island** 32  
The USAF Sets Up A Monitoring Post. *By SSgt. Joseph R. Lloyd*
- Books You'll Like** 44  
Pirates and Cookbooks. *By R.L. Slattery*

## COLUMNS

- Communications Confidential . . . . . 34
- You Should Know . . . . . 39
- Pirates Den . . . . . 43
- Telephones Enroute . . . . . 46
- Ham Column . . . . . 48
- Listening Post . . . . . 50
- Emergency . . . . . 54
- Scanning VHF/UHF . . . . . 58
- Broadcast DX'ing . . . . . 60
- Clandestine Communications . . . . . 63
- RTTY . . . . . 64
- Satellite View . . . . . 66
- Radar . . . . . 69
- CB Scene . . . . . 71
- Washington Pulse . . . . . 74
- How I Got Started . . . . . 76

## DEPARTMENTS

- Beaming In . . . . . 4
- Mailbag . . . . . 6
- New Products . . . . . 19
- Worldband Tuning Tips . . . . . 40
- Communications Shop . . . . . 77

*This month's cover: An OMNI Air Craft Beacon in Wyoming. Photo By Larry Mulvehill.*

## EDITORIAL STAFF

**Tom Kneitel, K2AES / KNY2AB**, Editor  
**George Doobin**, Associate Editor  
**Jeanine M. O'Connor**, Assistant Editor

## CONTRIBUTING EDITORS

**Gerry L. Dexter**, Shortwave Broadcast  
**Robert Margolis**, RTTY Monitoring  
**Gordon West, WB6NOA**, Emergency  
**Don Schimmel**, Utility Communications  
**Edward Teach**, Alternative Radio  
**Harold A. Ort, Jr.**, Military Consultant  
**Janice Lee**, Radar Detectors  
**Chuck Gysi, N2DUP**, Scanners  
**Havana Moon**, Clandestine Consultant  
**Roger Sterckx**, AM/FM Broadcasts  
**Ed Noll, W3FQJ**, Thoughts and Ideas  
**Donald Dickerson, N9CUE**, Satellites  
**Kirk Kleinschmidt, NTOZ**, Amateur Radio

## BUSINESS STAFF

**Richard A. Ross, K2MGA**, Publisher  
**Donald R. Allen, N9ALK**, Advertising Mgr.  
**Emily Kreutz**, Sales Assistant  
**Dorothy Kehrwieler**, General Manager  
**Frank V. Fuzia**, Controller  
**Catherine Ross**, Circulation Director  
**Melissa Kehrwieler**, Data Processing  
**Kathleen Bell**, Customer Service

## PRODUCTION STAFF

**Elizabeth Ryan**, Art Director  
**Barbara Terzo**, Artist  
**Dorothy Kehrwieler**, Production Manager  
**Emily Kreutz**, Production  
**Pat Le Blanc**, Phototypographer  
**Florence V. Martin**, Phototypographer  
**Hal Keith**, Technical Illustrator  
**Larry Mulvehill, WB2ZPI**, Photographer

A publication of



CQ Communications, Inc.  
76 North Broadway  
Hicksville, NY 11801-2953 USA.

Offices: 76 North Broadway, Hicksville, NY 11801. Telephone 516 681-2922. FAX (516) 681-2926. Popular Communications (ISSN 0733-3315) is published monthly by CQ Communications, Inc. Second class postage paid at Hicksville, NY and additional offices. Subscription prices: Domestic—one year \$19.95, two years \$38.00, three years \$57.00. Canada/Mexico—one year \$22.00, two years \$42.00, three years \$63.00. Foreign—one year \$24.00, two years \$46.00, three years \$69.00. Foreign Air Mail—one year \$77.00, two years \$152.00, three years \$228.00. Entire contents copyright © 1990 by CQ Communications, Inc. Popular Communications assumes no responsibility for unsolicited manuscripts, photographs, or drawings. Allow six weeks for change of address or delivery of first issue. Printed in the United States of America.  
Postmaster: Please send change of address to Popular Communications, 76 North Broadway, Hicksville, NY 11801.

# UNIVERSAL SHORTWAVE

Monitor More With Advanced Equipment From Universal!

## COMMUNICATIONS RECEIVERS

### Japan Radio NRD-525



For the communications connoisseur. Covers 1.34 MHz. Incredible performance and features. In stock. \$1149.95 (+\$12 UPS)

### Kenwood R-5000

A powerful receiver for the serious DXer. An exceptional value. \$849.95 (+\$11 UPS)

### Kenwood R-2000

Many features: mems., scan, sweep, FM mode, 24 hr. clock etc. \$649.95 (+\$10 UPS)

### Icom R-71A

A well-respected time-tested performer. Notch, 2 VFOs, keypad. \$849.95 (+\$9 UPS)

### Yaesu FRG-8800

Beautiful LCD display, keypad, memories and more. \$689.95 (+\$9 UPS)

## PORTABLE RECEIVERS

### Sangean ATS-803A



Keypad, memories, BFO, clock, RF gain, etc. A strong performer and unbeatable value. \$189.95 (+\$5 UPS)

### Sony ICF-2010

Super high performance and features. VHF air too. \$359.95 (+\$5 UPS)

### Magnavox D2999

A highly rated low cost fully loaded portable for every budget. \$289.95 (+\$5 UPS)

### Grundig Satellit 500

Hi-tech with beautiful fidelity and style. Synchronous tuning. \$499.00 (+\$5 UPS)

*Note: Radios listed above are all Lw-mw-sw-FM digital. Contact us for other models*

## SPECIAL RECEIVERS

### Icom R-9000



Solid all-mode coverage from .1 to 1999.8 MHz. Multi-function CRT with spectrum analyzer. The ultimate receiver! \$4795.00 (+\$28 UPS)

### Sony CRF-V21

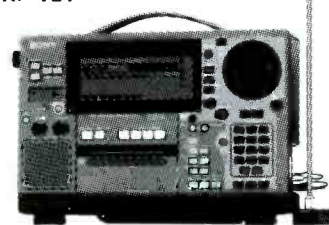

This LW/MW/SW/FM visual receiver has an LCD screen for spectrum analysis, memory and data display. Built-in decoder-printer for FAX and RTTY reception. \$4795.00 (+\$15 UPS)

## MULTI-MODE CONVERTERS

### Universal M-7000



The Universal M-7000 will permit you to intercept and decode Morse code, various forms of RTTY, FDM and FAX. Simple connections to your receiver and video monitor will enable you to monitor with the most sophisticated surveillance decoder available. No computer is required. See the world of shortwave excitement you have been missing. Requires 115/230 AC 50/60 Hz. Starting at \$999.00. Please write for full details.

- ◆ Morse Code (CW)
- ◆ Regular Baudot RTTY
- ◆ Variable Speed Baudot
- ◆ Bit Inverted Baudot
- ◆ ASCII Low & High Speed
- ◆ Sitor Mode A (ARQ)
- ◆ Sitor Mode B (FEC)
- ◆ ARQ 2&4 chan. (TDM)
- ◆ ARQ-E and ARQ-E3
- ◆ VFT Modes (FDM)
- ◆ Russian 3rd Shift Cyrillic
- ◆ Facsimile (FAX) AM/FM
- ◆ Packet 300 & 1200 AX.25
- ◆ Remote Terminal
- ◆ Literal & Databit Modes
- ◆ Variable & Standard Shift
- ◆ Automatic Tuning
- ◆ Diversity Reception

## COMMUNICATIONS BOOKS

### Passport To Worldband Radio 1990 Ed.

By L. Magne. Graphic presentation of all SWBC stations. Reviews too. *New!* ..... \$14.95

### Shortwave Receivers Past & Present

By F. Osterman. Your guide to 200 receivers with new-used value, specs, features. .... \$6.95

### Aeronautical Communications Handbook

By R. Evans. A mammoth book on all aspects of shortwave aero listening. 266 pages. . . \$19.95

### Complete SWL's Handbook Third Edition

By Bennett, Helms, Hardy. Nearly 300 pages on all aspects of SWL'ing. .... \$16.95

### Guide To Facsimile Stations

By J. Klingenfuss. The complete guide to FAX with freqs., schedules and addresses... \$19.95

### Shortwave Listening With The Experts

By G. Dexter. Over 500 pages and 25 chapters of in-depth info. on all aspects of DXing. \$19.95

### World Radio TV Handbook 1990 Ed.

All SWBC stations by country with schedules, addresses, power, etc. Reviews too. . . \$19.95

✓ Please add \$1 per title for shipping.

## MULTI-MODE CONVERTERS

### Universal M-900



Here is a compact, easy to use decoder that copies all the most important shortwave transmission modes. The M-900 covers Morse code for monitoring hams, ships and coastal stations. Baudot RTTY is included for decoding weather and international press broadcasts. Both Sitor A and Sitor B are supported for monitoring the extensive maritime and diplomatic traffic. Facsimile (to the printer only) lets you receive maps and pictures from around the world. Requires 12 VDC @ .8A Text output to video monitor. \$499.95 (+\$8)

- ◆ Morse Code (CW)
- ◆ Regular Baudot RTTY
- ◆ Sitor Mode A (ARQ)
- ◆ Sitor Mode B (FEC)
- ◆ Facsimile (FAX) FM
- ◆ Variable & Standard Shift

### M-900 System Components

A complete M-900 system would require:

- ▶ Universal M-900
- ▶ 12 VDC Power Supply
- ▶ Your SW Receiver
- ▶ Video Monitor
- ▶ Parallel Printer
- ▶ Cables for above

Please write to Universal for full information on the M-900 and the above optional items. Full system prices are available.

## COMMUNICATIONS CATALOG

Universal now offers a new combined communications catalog covering shortwave, amateur and scanner equipment. There is also an unbeatable selection of antennas, books, parts and accessories. This huge 88 page (8 1/2" by 11") publication covers everything for the radio enthusiast. With prices, photos and full descriptions.

★ Available for \$1 postpaid ★

## STORE HOURS

Monday - Friday 10:00-5:30  
 Except Thursday 10:00-8:00  
 Saturday 10:00-3:00

• We ship worldwide, • In business since 1942!  
 • Visa, MC, Discover • Used equip. list available  
 • Prices & specs. are subject to change.

## Universal Radio

1280 Aida Drive Dept. PC  
 Reynoldsburg, Ohio 43068 U.S.A.  
 Ohio: 614 866-4267 Toll Free: 800 431-3939

## Seeing America By Radio

One of the things I enjoy doing each year is hopping into the car and heading off on a meandering drive to distant points. Usually, there's no specific destination in mind. The only thing certain is that, traditionally, the trip is enhanced by the simultaneous and continuous operation of my 6 and 2 meter ham rigs, a CB rig, and a scanner. The melding of the sounds produced by these four machines going full tilt has been known to frighten small children playing in their yards as I drive past.

Let me add that the cacophony emerging from my mobile communications center doesn't ring up many points with my XYL, either. Besides the endless babble, invariably one of the radios manages to activate with something of a vital interest just as I am being required to accompany her, under force of arms, on a trek through a roadside attraction such as a field of fossilized dinosaur droppings, a granite quarry, or a grits factory.

After many years of these trips, the XYL finally noticed that nothing of special interest takes place on any of the communications equipment after the first billboard is spotted announcing an upcoming McDonald's, Burger King, Stuckey's, or other dispensary of ambrosia and carbonated drinks for the sustenance of weary travelers.

That may have had something to do with my having been become convinced to take this year's drive-to-nowhere minus all of the ever-playing communications equipment. In retrospect, I suppose that it was mostly because when told to make a choice between the XYL and the radios on the trip, I elected to leave the radios home. Radios can't be talked into carrying the luggage into the motel every night.

A last minute compromise was hammered out when I was approved to bring along the cellular phone. Also, I could carry an emergency CB rig in the trunk, and even bring along a handheld scanner so long as it wasn't used in the car except to monitor "special events." She had in mind events like the return of Comet Kohoutek, or the beginning of the next Ice Age.

So, off we roared down America's highways and byways, accompanied by an eerie silence. In the howling of the wind passing over the car, I thought that I could hear children playing in their yards calling out to me to ask what became of the awesome sound that used to emanate from the vehicle. Eventually, the silence caused me to do something I had never done before on one of these trips. I reached over and turned on the car radio. Wow!

I listen to AM and FM radio a lot. When I'm working, I always have a radio (and sometimes a scanner) going. When a person normally stays put in a geographic area, it's easy to get used to the accents and styles of local air personalities, the commercials, the products described, the music, news, and other programming run out over the handful of stations normally used for information and entertainment.

There is seldom reason to consciously think about the fact that what you are hearing is a unique mix specifically blended for the one area in which you live. Variations in this blend can skew different broadcasters towards specific ethnic or age groups, but stations in a given area have more similarities with one another than you might think, especially when compared en-masse to what you'll hear on an AM or FM radio in another area (or "market," as they call it in broadcasting).

Most of the AM/FM broadcasting I hear takes place in the nation's top ranked radio broadcast market (as ranked in the 260 markets rated by Arbitron). As with what a person might expect to hear in any of the ten top such markets, what I'm normally exposed to is about as distilled, purified, professional, refined, sophisticated, and structured as to be heard anywhere. That's all well and good, but it's akin to existing on a steady diet of caviar and truffles. Eventually your taste buds seem to dull out.

A hundred miles outside of the nation's Numero Uno radio market, much to my delight, I was reminded that radio wasn't all truffles and caviar. It was a hot dog, with everything!

No matter where you live, just because you are exposed to many commercials for certain popular products, it doesn't mean that those brands are advertised, sold, or even known everywhere else in the nation. Some products are sold under different names in various parts of the country. Not only that, the sales approach for a product can vary widely from one area to another. Because of this, tuning in broadcasters beyond your normal scope of listening produces a new array of products such as sodas, beers, motor oils, etc. being offered in different accents than you've become familiar and comfortable with. It's jarring.

Of course, outside of major urban areas there are products being pitched in radio commercials that a person would be unlikely to ever hear about. These are products like hog feed, agricultural chemicals, tractors, well drilling services, seed, propane gas, aerial sprayers, and many others.

Beyond the limits of metro areas, you're likely to hear news broadcasts that sound alien to big-city ears. They include farm and livestock prices and information, agricultural factors in the weather forecasts, high school events and activities, minor league baseball scores, local-event bulletin boards, and even more emphasis on local/regional activities than on world events.

This is all like a breath of fresh air, especially if you are lucky enough to tune across a station that is staffed with several fledgling air personalities. These people are tomorrow's polished professionals; some stay at hometown stations, others gravitate to urban area stations. Sharing their early mike moments is really a wonderful experience you can't get in a "major market."

The best one of these folks I heard this year was on a station in rural Pennsylvania. He was spinning oldies and asking trivia questions "for big prizes." His major question was a real stumper, and he was getting flustered because many people had called in, but none with the correct answer. He said that he'd give it one more call before he moved on to another question. I thought I knew the answer, so I called in on my car phone. The fellow was excited that someone knew the answer, but even more turned on that I was the first out-of-towner ever to call him, and the first person to call the station from a cellular phone.

He insisted on patching me through on the air, eventually inviting me to drop by the station for a visit and to pick up my prize. If I ever get to that town again, I hope to collect on the prize, which is a gift certificate from the local farrier. First I have to find out what a farrier is. I thought he had said the gift was from a local *furrier*.

You hear a lot more country and trucker type music on stations outside of metro areas. It was the first time I had ever heard a Slim Whitman recording anyplace other than the TV commercial that sells his records. And there were records by Bob Wills, The Hoosier Hotshots, Tex Ritter, and other old-timers that urban country music stations ignore these days.

An unexpected gem was WAMU (88.5 MHz) in Washington, DC with its spectacular bluegrass music. I copied their signal until I was way back in the mountains of western Virginia. Sure would like to have bottled a couple of 1-gallon jugs of that music and taken it home with me.

Honorable mention to bluegrass station WPUV (1580 kHz) in Pulaski, VA. More-

(Continued on page 70)



# OPTOELECTRONICS

## The only name in HANDI-COUNTERS

Check These Incredible Features  
On The All New UTC3000

- **10Hz to 2.4GHz Range.**  
Simply amazing!
  - **10 Digit LCD Display.**  
1Hz resolution to over 150 MHz direct.  
Readable in bright sunlight.
  - **RF Signal Strength Bargraph.**  
16 Segment, Zero, & Full Scale adjustment.  
SEE the input signal!
  - **Super Sensitivity.** <1mV 10-200MHz,  
<5mV to 2GHz for efficient antenna pickup.
  - **6 Functions.** Frequency, Period, Ratio  
Time Interval, Average, & Prescale.
  - **Hold Button.**  
"Locks in" your exact Measurement FAST!
  - **Extruded Aluminum Enclosure.**  
Designed to fit every hand.
  - **Priced Right! Only \$375.**  
Includes Nicads, AC Charger/Adapter.
- Or Select Our Most Popular  
**HANDI-COUNTER**, the model 2210  
that set the standard in handheld  
frequency counter technology!  
**Value Priced at only \$239.**

Professionals and Hobbyists all over  
the world have chosen OEI for 16  
years! **Shouldn't YOU?**

**HANDI-COUNTERS! ...Only from OEI!**  
Choose the model that fits your needs...  
and your budget! **CALL NOW!**

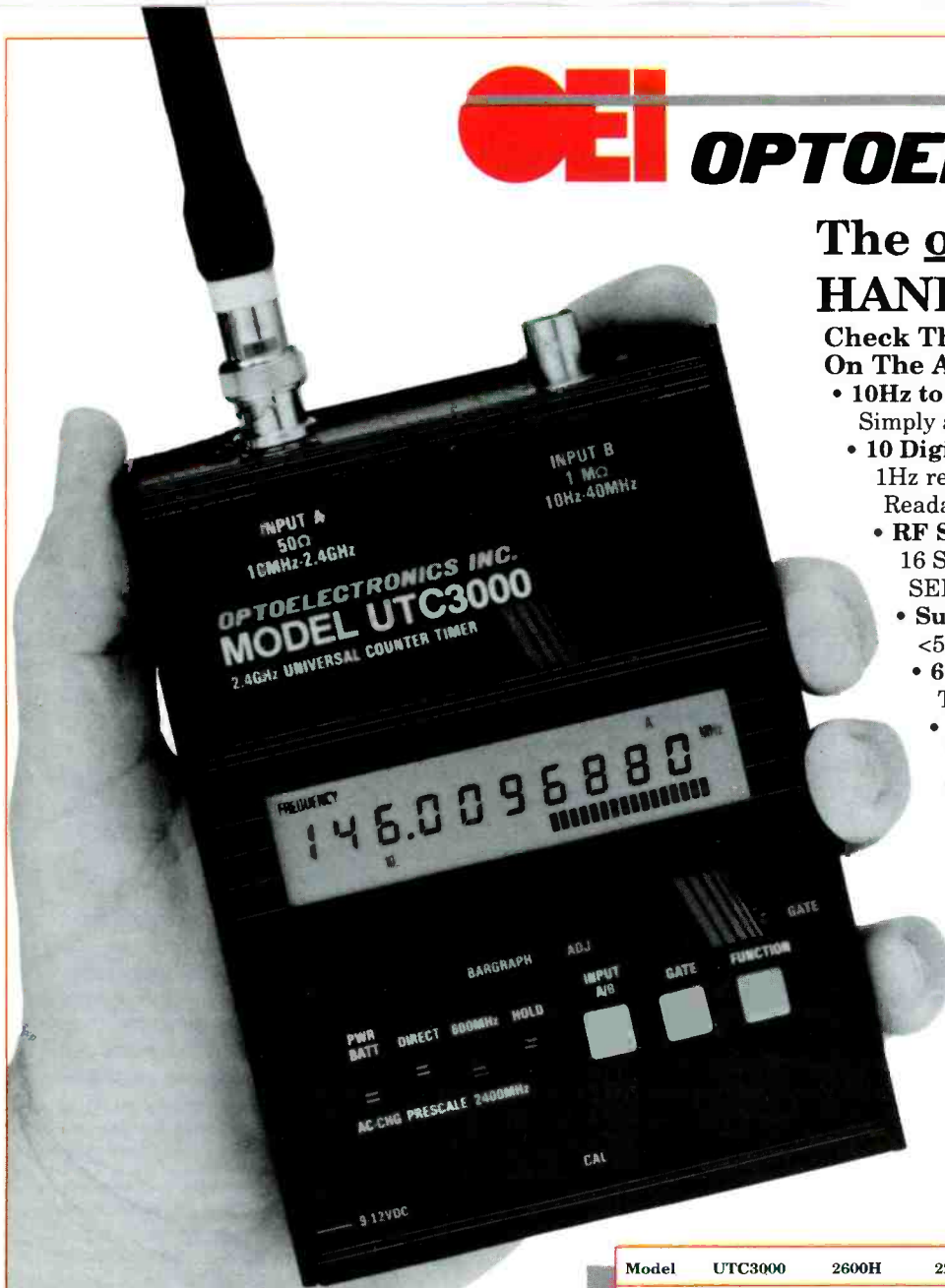

### UTC3000

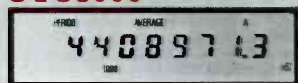

Period Average Mode



Display Showing All Annunciators

| Model                                       | UTC3000   | 2600H                                | 2210            | 1300H/A         | 2400H            | CCA                                 | CCB                                  |
|---|---|--------------------------------------|-----------------|-----------------|------------------|-------------------------------------|--------------------------------------|
| <b>Function</b>                             | Freq, Period<br>Ratio, Interval,<br>Avg, Prescale | Frequency                            | Frequency       | Frequency       | Frequency        | Frequency                           | RF<br>Indicator                      |
| <b>Range</b>                                | 10Hz-<br>2.4GHz                                   | 10MHz-<br>2.4GHz                     | 10Hz-<br>2.2GHz | 1MHz-<br>1.3GHz | 10MHz-<br>2.4GHz | 10MHz-<br>550MHz                    | 10MHz-<br>1.8GHz                     |
| <b>Display</b>                              | 10 Digit<br>LCD<br>w/Function<br>Annunciators     | 10 Digit<br>LCD                      | 8 Digit<br>LED  | 8Digit<br>LED   | 8 Digit<br>LED   | 8 Digit<br>LED                      | *                                    |
| <b>RF Signal<br/>Strength<br/>Indicator</b> | 16 Segment<br>Adjustable<br>Bargraph              | 16 Segment<br>Adjustable<br>Bargraph | *               | *               | *                | LED with<br>Adjustable<br>Threshold | 10 Segment<br>Adjustable<br>Bargraph |
| <b>Price</b>                                | <b>\$375.</b>                                     | <b>\$325.</b>                        | <b>\$239.</b>   | <b>\$179.</b>   | <b>\$189.</b>    | <b>\$299.</b>                       | <b>\$119.</b>                        |

Sensitivity: <1 to <10mV typical. Time Base: ± 1.ppm.; ± 5ppm. add \$75 - LED Models; ±2ppm add \$80. - LCD Models. Nicads & AC charger/adaptor included. (9v Alkaline - CCB.) Carry Case, Antennas and Probes extra. One year parts & labor warranty on all products.



## OPTOELECTRONICS

5821 NE 14th Avenue • Ft. Lauderdale, FL 33334

Toll Free Order Line:  
**1-800-327-5912**

FL(305)771-2050 • FAX(305)771-2052



Visa, MC, COD, Cash, M.O accepted. Personal  
Check allow 3 weeks. 5% Shipping, Handling,  
(Maximum \$10) U.S. & Canada. 15% outside  
continental U.S.A. In FL add 6% sales tax.



# MAILBAG

## LETTERS TO THE EDITOR

Each month we select representative reader letters for our Mailbag column. We reserve the right to condense lengthy letters for space reasons. All letters submitted for consideration must be signed and show a return address. Upon request, we will withhold sender's name should the letter be used in Mailbag. Address letters to Tom Kneitel, Editor, Popular Communications Magazine, 76 North Broadway, Hicksville, NY 11801.

### I Didn't Hear The Weasel

In the December issue editorial (*Beaming In*) you quoted Pogo, a long time resident of the Okefenokee Swamp. The quote was as accurate as it was appropriate, but your reference to Pogo as being a "weasel" was incorrect. Last week I was in the Okefenokee Swamp, and I believe that Pogo is still an opossum—or possum as we say in South Georgia. Here in Waycross, GA we hold the annual Pogo Festival (in October) to honor Pogo and his friends. We like to see Pogo being quoted, but hope that you will discontinue confusing nocturnal arboreal marsupials with carnivorous mammals. I am the Deputy Civil Defense Director for Waycross-Ware County. If you come through this way, be sure to visit the beautiful Okefenokee Swamp at Waycross. And continue your good work with POP'COMM, I've been a reader of yours since your tenure with S9 magazine in the 1970's.

Jack Hobbs,  
Waycross, GA

*I stand corrected, but no offense was intended. "Weasel" is the word I usually describe any small four-legged furry critter that can't easily be described as either a dog, a cat, or a troll—Editor.*

### Do It That Way Or Disk Way

I've prepared some material that I want to submit for consideration to POP'COMM. It's all in my computer, and I can make hard copies on my printer. When I received your guide for authors, it mentions that material prepared on a dot matrix printer isn't appreciated there. Can you take the floppies themselves?

L.R. Harewood,  
Del Rio, TX

*We might be able to. We use IBM clones in the office. They are equipped with 5¼" 360K drives only. We can't work with 5¼" 1.2 M disks or any of the 3½" formats. Our*

*preferred file type is Wordstar 4.0, but we can handle Wordstar 5.0, Wordperfect 4.2, Wordperfect 5.0, or Multimate. If you can't produce text in one of these formats, then we can work with ASCII files. For all of those who have asked about submitting material to us on a disk, we can furnish you with additional information on article preparation if you write and mention that you want to send your material in this way rather than on paper—Editor.*

### We Received This Cable

My TV cable has been out for an hour or more twice this week. Last week it was having problems. If it rains hard or gets windy, or there's lightning, the service degrades or else quits altogether. The converter box I have is a rebuilt one that doesn't work properly. So was the converter this one replaced. If the cable is out an hour or so an evening when I want to watch, I can't be reimbursed for my loss. If it's out longer (which happens), it's possible to get credit but not unless I request it. It isn't automatic. Can you imagine an industry that expects you to pay them for not delivering the service or product they sell? POP'COMM suggested that the FCC deregulated the cable TV industry too quickly, but must seriously reconsider that decision. Here's my second to your vote, with the hope that local competition for customers from different cable companies be allowed.

R.W.W.,  
New York

### Where's The Story?

There haven't been any articles about the stations that operate between 400 and 406 MHz. What's going on there? Why no articles?

Victor J. Balt,  
Ponca City, OK

*Mostly the band is used for transmitting telemetry and data signals in conjunction with environmental monitoring projects and wildlife tracking. Also, there are some satellite signals there, including ARGOS on 401.65 MHz which relays environmental data and can track buoys and tagged wildlife. Another is the GOES data collection system at 401.7 to 402 MHz, used for real-time transmission of geophysical observations and river levels. A third is SARSAT (Search and Rescue Satellite-Aided Tracking), operated by Canada, the U.S.A. and France on 406.05 MHz. The USSR's COSPAS system operates on the same frequency. These are used to locate downed*

*aircraft and ships in distress. The NOAA operates a number of ground based "wind profiler" radars throughout the western and midwestern states on 404.37 MHz. The average scanner owner just hasn't gotten around to fully exploring the mysteries of this band yet, so nobody's sat down to tell their experiences there—Editor.*

### He Received Mail

Thank you for publishing my article on DX'ing last year. As a result, I received dozens of letters from POP'COMM readers. I responded to as many as I was able, but it was physically impossible to get to each and every one. All were greatly appreciated and welcome. Thanks to all who wrote.

Igor Sannikov  
ul.Oparina 6, kv.37,  
Kirov 610 008, USSR

### Chip Ahoy

POP'COMM is one of the best and most independent technical magazines on the stands today. Each month, I read it cover to cover, including the classifieds. In the April issue, I especially appreciated the *Chip Ahoy* story in *Beaming In*. The point you made about the rapid obsolescence of highly specialized chips was most relevant. Note that it would be impossible today for you or I to build, from scratch using vacuum tubes (assuming that tubes were easily available, which they aren't), a copy of anybody's state-of-the-art scanner! The gadget we put together would simply be too big! Tubes are single-problem solving devices, while chips solve multiple problems. A single chip can have, say, 75,000 transistors aboard—easily. And each transistor is equivalent to a vacuum tube. The incredible scale that we are dealing with here is difficult for many people to grasp. Our civilization is rapidly becoming dependent upon a technology that is so complex, so difficult for the average person to understand, that it is for all intent and purposes akin to "magic"—as magic was understood in medieval times. Television sets, computers, cellulars, VCR's, scanners, CD players, digital recording, I believe will soon be viewed literally as "magic" by the average person—within just a few decades given the state of our current education—maybe sooner. It's not all that bad; note that in such a society the person who fixes such "magic" devices will probably have the same status roughly equivalent to a medieval alchemist; feared, but respected.

Douglas Blaine Kenney  
Carle Place, NY





"The Largest Dealer of Scanners in the World"

# SCANNER WORLD, USA

10 New Scotland Ave., Albany, NY 12208 • 518/436-9606

**SCANNER WORLD EXCLUSIVE**

**UNIDEN BEARCAT BC205XLT**

**\$259.99** (\$7.00 shipping)

Digital programmable 200 channel hand held scanner with raised button keyboard for easy programming of the following frequency ranges: 29-54 MHz, 118-174 MHz, 406-512 MHz, 806-956 MHz. \* Features include: Scan delay, memory backup, key pad lock, sidelit liquid crystal display, channel lockout, 10 twenty channel banks, direct channel access, automatic search, full one year factory warranty, 10 priority channels, Ni-Cad battery pack, AC adapter/charger, flexible rubber antenna carry case are all included. Size is 2-11/16"Wx1-3/8"Dx7-1/2"H (Optional extended 2 yr. warranty \$299.99, 3yr. extended warranty \$399.99.) (\* Excludes Cellular)

**REGENCY TS-1**

35 CHANNELS — MOBILE/BASE

Special



**\$149.99** (\$7.00 shipping)

Features include simple programming of the following frequency ranges: 29-54 MHz, 118-175 MHz, 406-512 MHz. Turboscan, digital display, priority, search, lockout, delay, dim control, top mounted speaker, one year factory warranty. Includes AC & DC cords, mobile mounting bracket, telescope antenna. All for only \$149.99 plus \$7.00 shipping. (Optional extended warranty: 3 years \$39.99; 2 years \$29.99.)

**UNIDEN RD9XL RADAR DETECTOR**

SPECIAL LOW PRICE OF ONLY

**\$129.99** (\$7.00 shipping)



RD9XL has been rated best radar detector for 1990 by Car & Driver Magazine. Better than Passport, Whistler, and all others. RD9XL includes cigarette lighter cord, mute/audio switch, city/highway switch, mounting bracket, carry case, signal strength meter, dual tone audible alarm, bright warning lamp, plus the very small size of only 2-5/32"Wx3 1/2"Dx11 1/16"H.

**REGENCY R-4010**

**\$106.99** (\$7.00 shipping each)

10 channel hand-held scanner. (Same Scanner as Bearcat 55XLT), 29-54 MHz, 136-174 MHz, 406-512 MHz, digital programmable, keyboard lock switch, lockout, includes rubber flex antenna. (Optional accessory 5W-41 only \$19.99 includes rechargeable Ni-Cad batteries, AC adapter/charger and cigarette lighter cord.)



**REGENCY Z-60**

**\$119.99** (\$7.00 shipping)

Programmable 60 channel, AC/DC, digital, 30-50 MHz, 88-108 MHz, 118-136 MHz, 144-174 MHz, 440-512 MHz, priority, clock, lockout, telescopic antenna, AC/DC cord, search, delay.

**UNIDEN BEARCAT BC-400XLT**

**\$99.99** (\$7.00 shipping)

Our best selling mobile scanner, 16 channel, AC/DC, programmable, digital, AC/DC cords, telescopic antenna, mobile mounting bracket, weather search, priority, 29.54 MHz, 136-174 MHz, 406-512 MHz, external speaker and antenna jack.

**COBRA SR-925**

**\$99.99** (\$7.00 shipping)

Digital programmable, 16 channel AC/DC mobile/base with raised button keyboard for easy programming of the following frequency ranges: 29-54 MHz, 118-174 MHz, 406-512 MHz. Covering aircraft, marine, police, fire, weather, trains, public service, plus much more. Features include: digital display, priority, scan delay, weather button, channel lockout, search, scan speed, automatic squelch, memory backup. One year factory warranty, external speaker jack. (Extended warranty 2 years extra \$29.99, 3 years extra \$39.99.)

**REGENCY R-2066**

**\$109.99** (\$7.00 shipping)

Digital programmable, 60 channels, AC base scanner, 30-50 MHz, 144-174 MHz, 406-512 MHz. Size 7 1/2"x3"x9". Turbo-Scan scans 40 channels per second, 4 channel banks, weather alert, search, priority, lockout, AC cord, telescopic antenna, plus much more.

**EXTENDED WARRANTY SERVICE**

This extended service contract is for all scanners, CB radios, radar detectors, and cordless telephones that have been purchased anywhere in the USA in the past 30 days. This extended warranty service begins when your original manufacturer's warranty expires.

1 year extended warranty ... only \$18.99  
2 year extended warranty ... only \$29.99  
3 year extended warranty ... only \$39.99

**RADIO SCANNERS AND ACCESSORIES**

|                         |          |        |
|-------------------------|----------|--------|
| Bearcat BC145XL         | \$99.99  | (7.00) |
| Bearcat BC140           | 94.99    | (7.00) |
| Bearcat BC175XL         | 139.99   | (7.00) |
| Bearcat BC55XLT         | 119.99   | (6.00) |
| Bearcat BC800XLT        | 264.99   | (7.00) |
| Bearcat BC100XLT        | 199.99   | (7.00) |
| Bearcat BP205           | 34.99    | (*)    |
| Bearcat BC210XLT        | 189.99   | (7.00) |
| Bearcat BC-ONE          | 129.99   | (7.00) |
| Bearcat AD-100U         | 14.99    | (*)    |
| Bearcat PS-001          | 12.99    | (*)    |
| Bearcat VC-001          | 11.99    | (*)    |
| Bearcat AD-140U         | 14.99    | (*)    |
| Bearcat AT-054          | 12.99    | (*)    |
| President HR2600        | 219.99   | (8.00) |
| President HR2510        | 239.99   | (8.00) |
| Regency R3020           | 98.99    | (7.00) |
| Regency INF 7           | 99.99    | (7.00) |
| Regency INF-50          | 94.99    | (7.00) |
| Regency MA-917          | 24.99    | (*)    |
| Regency MA-501          | 14.99    | (*)    |
| LifeGard 4              | 117.99   | (4.00) |
| RXD MRP-1               | 24.99    | (*)    |
| GRE8001                 | 62.99    | (4.00) |
| GRE8002                 | 79.99    | (4.00) |
| Midland CB Radios       | In Stock |        |
| Cobra CB Radios         | In Stock |        |
| Uniden CB Radios        | In Stock |        |
| Silver Eagle Microphone | 69.99    | (*)    |
| Antennas                | In Stock |        |
| Rechargeable Batteries  | In Stock |        |

**BOOKS**

|                     |       |     |
|---------------------|-------|-----|
| Covert Intelligence | 8.95  | (*) |
| Air Scan Directory  | 14.99 | (*) |
| Betty Bearcat       | 7.99  | (*) |
| Top Secret          | 14.99 | (*) |
| Covert Techniques   | 9.95  | (*) |
| Tomcat's Big CB     | 13.95 | (*) |
| World Radio         | 18.99 | (*) |
| Monitor America     | 5.99  | (*) |
| Survival Directory  | 6.95  | (*) |
| Rail Scan           | 7.95  | (*) |
| Police Call         | 6.99  | (*) |
| Embassy & Espionage | 13.99 | (*) |

**TWO-WAY RADIOS REGENCY-RELM**

|                   |        |        |
|-------------------|--------|--------|
| UC102             | 109.99 | (5.50) |
| UC102 (2 or more) | 99.99  | (5.50) |
| RH-256B           | 329.99 | (9.00) |
| RH-606B           | 469.99 | (9.00) |
| WHS-1             | 399.99 | (9.00) |
| RU-156B           | 459.99 | (9.00) |
| UC-202            | 134.99 | (6.00) |

**BEARCAT 70XLT 20 CHANNEL HAND-HELD SCANNER**

**\$169.99** (\$7.00 shipping)

Small size 6"Hx1"Dx2 3/4"W. Full digital readout, priority, search, channel lockout, scan delay, key lock. Covers following frequencies: 29-54 MHz, 136-174 MHz, 406-512 MHz. Package includes rubber antenna, rechargeable Ni-Cad battery pack, AC adapter/charger and carry case.

**REGENCY R-4020**

100 Channel Digital Programmable Hand-Held Scanner

**\$174.99** (\$7.00 shipping)

Our best price ever on a full featured complete package hand-held scanner. Manufactured by Uniden, this is the exact duplicate of the Bearcat 100XLT for a much lower price. Features include 11 bands of weather, aircraft, public service, trains, marine, plus more (29-54 MHz, 118-174 MHz, 406-512 MHz), 10 channel banks, 10 priority channels, lighted LCD display, earphone jack, channel lockout, AC/DC operation, scans 15 channels per second, track tuning. Special package deal includes following accessories: AC adapter/charger, rechargeable Ni-Cad battery pack, flexible rubber antenna, heavy duty carry case.

**SANGEAN ATS-803A**

SHORT WAVE RECEIVER **\$189.99** (\$7.00 shipping)



AM/FM/LW and 12 short wave bands plus FM stereo, BFO for SSB reception, clock radio. Includes AC adapter, telescopic antenna, stereo headphones, and shoulder strap.

**—SHORT WAVE WORLD BAND RECEIVERS AVAILABLE—**

|                                  |          |         |
|----------------------------------|----------|---------|
| Grundig Satellit 500             | \$548.99 | (10.00) |
| Grundig Yacht Boy 220            | 106.99   | (5.00)  |
| Grundig Cosmopolit               | 198.99   | (7.00)  |
| Grundig Yacht Boy 230            | 149.99   | (5.00)  |
| Grundig Satellit 650             | 899.99   | (20.00) |
| World Radio & TV Handbook (1990) | 18.99    | (*)     |

**— RADAR DETECTORS —**

|                |         |                |          |
|----------------|---------|----------------|----------|
| Cobra RD-2102  | \$64.99 | Cobra RD-3170  | \$168.99 |
| Cobra RD-2110  | 66.99   | Cobra RD-3112  | 98.99    |
| Cobra RD-3120  | 104.99  | Cobra RD-3168  | 138.99   |
| Cobra RD-5110  | 159.99  | Maxon RD-3     | 67.99    |
| Maxon RD-25KL  | 86.99   | Maxon RD-65    | 126.99   |
| Maxon RD-21A   | 69.99   | Maxon RD-2A    | 49.99    |
| Uniden RD-9XL  | 129.99  | Uniden RD-99GT | 129.99   |
| Uniden RD-95GT | 129.99  | Uniden RD-500  | 65.99    |
| Uniden Talker  | 109.99  | Uniden RD-9    | 114.99   |
| Uniden RD-25   | 58.99   | Uniden RD-3XL  | 154.99   |

**NEW!**

**UNIDEN MR-8100 \$489.99** (\$9.00 shipping)



100 channel professional mobile scanner, 10 banks of 10 channels each, scans any combination of 100 channels. Scans 30 or 100 channels per second, lockout individual channels, scan delay, digital display, hold button, priority, internal memory when power is lost, programs direct from keyboard, operates on 12 VDC. Includes mobile power cord, mounting bracket, external speaker, and programming instructions. Dimensions 5-1/2"x6-7/8"x1-3/4". Frequency coverage 29-54 MHz, 118-174 MHz, 406-512 MHz, 806-956 MHz. (Optional diskette [5%\*] or 3 1/2"\*) available for programming MR-8100 direct from your PC to restore cellular, for professional use only. Uses RS-232 connection \$24.99.) Not available from Scanner World in OR, WA, ID, NV, AZ, or CA.

**UNIDEN BEARCAT BC-600XLT**

**\$199.99** (\$7.00 shipping)



Digitable Programmable 100 Channel Scanner

BC 600XLT covers the following frequencies: 29-54 MHz, 118-174 MHz, 406-512 MHz. Features compact size of 6-5/16"Wx1-5/8"Hx7-3/8"D, scan delay, priority, memory backup, channel lockout, bank scanning, key lock, AC/DC power cords, telescopic antenna, mounting bracket supplied, one year factory warranty, search, direct channel access, track tuning, service search including preprogrammed frequencies by pushing a single button for police fire/emergency, aircraft, weather, and marine services plus exclusive optional features never available on any scanner before. First is an RF receive amplifier for boosting weak signals for only \$24.99 plus a CTCSS tone board is available for only \$59.99 to make this the number one scanner available in the USA. Optional cigarette lighter plug #600MPC \$4.99.

**BEARCAT BC-950XLT**

Same features as BC-600XLT but also receives 800-954 MHz. (Excludes cellular)

**\$249.99** (\$7.00 shipping)

**ORDERING INFORMATION:** Call (518) 436-9606 to place orders or mail orders to Scanner World, USA, 10 New Scotland Ave., Albany, N.Y. 12208. Orders will be shipped within 24 hours by United Parcel Service if order is accompanied by MasterCard, Visa, cashier's check, money order, COD (COD shipped by United Parcel Service will be cash or money order only). (If a COD package is refused, customer will be billed for shipping and COD charges.) Mail orders with personal or business checks enclosed will be held 4 weeks for bank clearance. Prices, specifications, and terms subject to change without prior notice. If items are out of stock we will backorder and notify you of delivery date. All shipments are F.O.B. Scanner World® warehouse in Albany, N.Y. We are not responsible for typographical errors. All merchandise carries full manufacturer's warranty. Bid proposals and purchase orders accepted from government agencies only. Free full line catalog mailed 4 times per year. Merchandise delivered in New York State add 7% sales tax. No returns accepted after 7 days of merchandise receipt. \*Add (\$) per item, and \$3.00\* for all accessories ordered at same time. COD orders will be charged an additional \$4.00 per package. Full insurance is included in shipping charges. All orders are shipped by United Parcel Service to street address only. (No P.O. Box). Shipping charges are for continental USA only. All others ask for quote on shipping charge.

# Still Left

## How The World's Changing Political Climate Affects Your Listening

BY GERRY L. DEXTER

**T**he collapse of communist rule in so short a period requires all the adjectives at our command in order to describe it. Unfortunately, the Al Michaels, Dick Vitales and the ad writers of this world have left us "adjectively" bankrupt. Somehow, the word "unbelievable" used to describe a thousand hook shots a season, falls short when applied to the Communist Party Central Committee's vote to dispense with political exclusivity in the Soviet Union.

Poland, Hungary, Bulgaria, Czechoslovakia, East Germany and Romania have all reached, or are very close to, the point of now having a non-communist government. Many SWL's have followed these tremendous events on shortwave, often direct from the government radios involved. We've heard announcers on these stations apologizing for not telling the truth to their listeners over the years.

But all of the dominos haven't fallen yet. There are still countries which cling to the old ways, or at least pay it lip service. In fact, more than a dozen countries still call themselves communist. So, as shortwave listeners we can still tune in on the propaganda

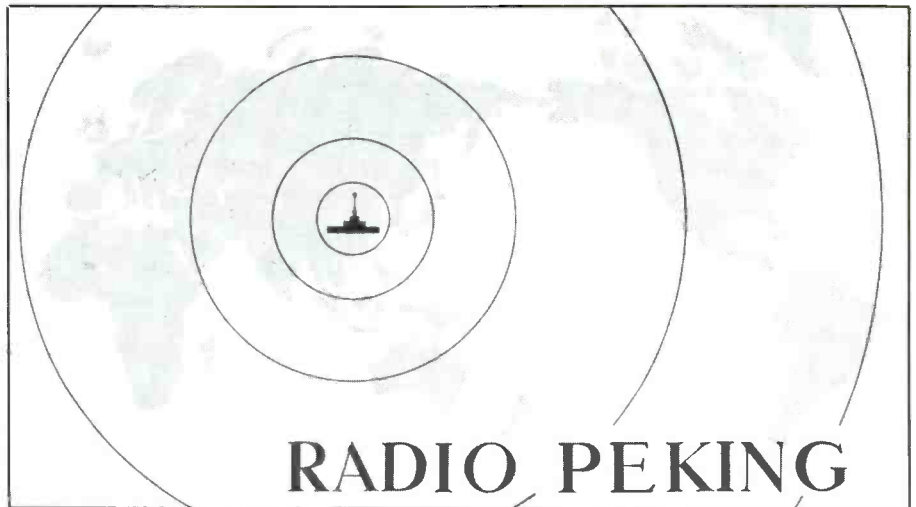

Through thick and thin Radio Beijing has always been good about responding to mail. This card dates to before "Peking" became "Beijing".

and even enjoy some DX challenges in the process. Stations which provide fairly good and reliable signals can also be monitored for signs of movement towards the kinds of changes we've seen elsewhere.

Let's take a look at those that are still left. (And yes, we know that not everyone may agree on the political pigeonholing).

**People's Republic Of China**—A civil war between Chiang Kia-shek's Koumin-

Transmitting towers at the Voice of Ethiopia.

This card from the Angolan government station goes back to the days when Angola was still a Portuguese possession.

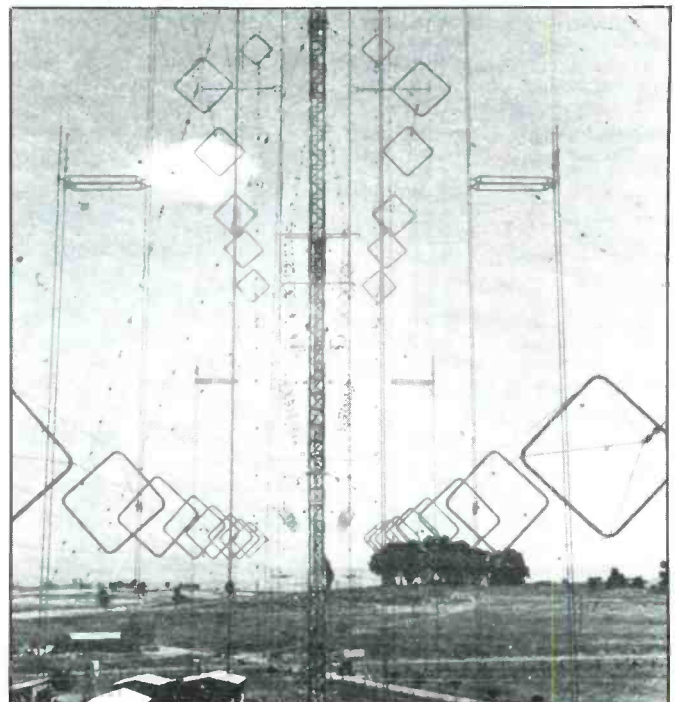

tang nationalists and Mao Tse-tung's communists ended with Mao on a balcony in Beijing declaring a People's Republic. Many shortwave listeners sat glued to their sets a year ago as Radio Beijing first ignored, then covered the democracy movement and then denied it even happened.

Radio Beijing has several English language transmissions to North America. Their most recent schedule shows English at 0000-0100 on 9655, 9770 and 11715, 0300-0400 on 9690 and 11715, 0400-0500 on 11695, 0500-0600 on 11840, 1100-1300 on 9665, all for the east coast of North America. For the west coast, transmissions are aired at 0300-0400 on 9770 and 17855, 0400-0500 on 11695, 5000-0600 on 11840, 1400-1600 on 7405. Radio Beijing is very good about providing schedules on request so it's not difficult to keep up with changes if you get on their mailing list.

#### **Mongolian People's Republic—**

Mongolia has been under communist rule nearly as long as the Soviet Union. A people's republic was established in 1924. It has a long alliance with the USSR and receives considerable aid from Moscow.

The state broadcaster, Radio Ulan Bator, isn't known for its booming signals in North America, nor is it a rare DX catch. The station airs four English language segments, one to Europe, one to Australia and two to Asia—the latter two offer the best reception in North America. Try at 1200-1235 and 1445-1520 on 9615, 11990 and 12015. Listeners in most parts of North America will find the 1200 broadcast 12015 gives the best reception.

**State Of Cambodia**—This country is in a flux situation and by the time you read this it may have shed another of its skins. The country traces its history back to the beginning of the Christian era when it was the Kingdom of Fou-nan. The Vietnam war spilled over into Cambodia and the head of state, Prince Sihanouk, was deposed by the military in 1970. That government was overturned five years later by the murderous Khmer Rouge. The Vietnamese invaded in 1979 and installed their own version of a communist government. Guerrilla forces of the Khmer Rouge, the Prince and former Prime Minister Son Sann are all trying to overthrow the government. The Vietnamese have left but neither guns nor diplomacy have sorted things out yet.

The Voice of the People of Cambodia is a hard one to hear, much less hear at arm-chair level. English broadcasts are scheduled at 0000-0015 and 1200-1215 on 9695 and 11938. The latter frequency at 1200 usually offers the best opportunity.

#### **Lao People's Democratic Republic**

The Vietnamese-backed Pathet Lao waged a 20 year war against the American-backed Royal Lao government. A coalition government was agreed to in 1974 but the Pathet Lao soon took full power after communist victories in South Vietnam and Cambodia.

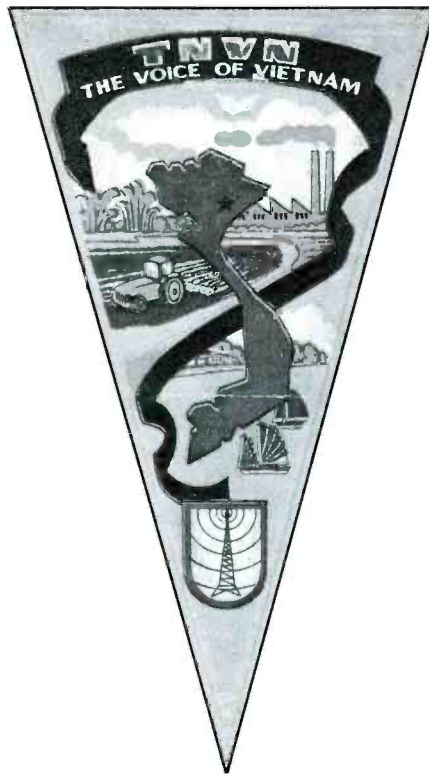

*For a time, the Voice of Vietnam sent a multi-colored pennant with QSL replies.*

The government recently adopted plans to induce more foreign investment and allowed a small increase in the private sector's economic activity, at the same time pulling back a bit on centralized economic planning.

Lao National Radio is one of the toughest in the group to log. The best opportunity is on 7112 (variable) between 1130-1400. English airs at 1330. If that doesn't work you can try the strongest of the regional stations Savannakhet on 7385 (variable) between 1100-1400. Lao National Radio is also relayed over Radio Moscow's facilities at 1100-1130 on 11870 and 15190, in French.

**Socialist Republic Of Vietnam**—The French lost the north in 1954, the US lost the south two decades later. The communist Party of Vietnam holds power. The economy is in wretched state and little foreign aid is coming in. The government has legalized small family businesses and is moving towards somewhat less central control.

The Voice of Vietnam is well heard in western North America, considerably less so in the eastern part. Still, some sort of signal is usually present. And easy to spot, too, thanks to the station's use of oddball frequencies. English is aired at 1000 on 9840 and 15010, 1100 on 7430 and 9730, 1330 on 9840 and 15010, 1545-1600 on 10010 and 12035, 1600 on 9840, 10010, 12035 and 15010 and 1800, 1900, 2030, 2230 and 2330 on 9840 and 15010.

**People's Democratic Republic Of North Korea**—The Russians marched into Korea in August, 1945 and set up a com-

munist-led provisional government. Political dancing over the next year led to the establishment of a people's democratic republic in 1948. The sole party is the Korean Worker's Party. North Korea retains one of the communist world's last remaining personality cults in the worship of Kim IL Sung. Still, there is some progress: 1981 saw the lifting of a 40 year ban on travel to North Korea by non-communist tourists!

Radio Pyongyang is being heard fairly well in these days of good high frequency conditions. English to North America is on the air at 0000-0050 on 15115 and 15160, 1100-1150 on 9600, 9977 and 11735, 1300-1350 on 9325, 9345, 9600, 11335 and 11735 (some of these are to Europe and Asia). Also to North America at 2300-2350 on 11735 and 13650.

A note on QSL'ing here. US citizens will have better luck if a way can be found to have the report mailed from somewhere outside the USA.

#### **People's Democratic Republic Of Yemen**

—In 1967, the Sultanates of the Federation of South Arabia were overrun by forces of the National Liberation Front. The NLF declared the country the South Yemen People's Republic in 1967, then changed it to the current name in 1970. The Yemeni Socialist Party runs the show here—and it's not much of a show.

The Democratic Yemen Broadcasting Service (DYBS) is heard fairly often from 0300 sign on, on 7190, all in Arabic. That broadcast runs until 0600.

#### **Democratic Republic Of Afghanistan**

—His cousin and brother-in-law overthrew the king in 1973 and declared Afghanistan a republic. A military coup in 1978 led to the establishment of a pro-Soviet government, but when it began to waver the Soviets invaded, set up a puppet government and got bogged down in an 11 year war. When the Soviets pulled out in February, 1989 all the experts predicted an early end for that government, but it has held against the mujahadeen guerrillas so far. There are even whispers now that some sort of deal may be worked.

The Russians may have left, but Radio Afghanistan is still relayed by stations inside the USSR and these are the ones which normally provide the best reception, though it's still marginal. The home service, via the USSR, on 4740 is often noted in Pashto/Dari around 1200. The foreign service has English scheduled at 0900-1030 on 4450, 6085, 9635, 15225 and 17655 and at 1900-1930 pm 7310 and 9665.

**Ethiopia**—The military deposed emperor Haile Selassie in 1974 and, by 1977, Colonel Mengistu Haile Mariam had emerged as strongman and a Marxist state had been declared. Strong Soviet support for the government economically and militarily in the war against secessionist rebels has been scaled back and government forces are doing poorly against the opposition. The economic situation is growing steadily worse.

# Organize and Protect Your Copies of **POPULAR COMMUNICATIONS**

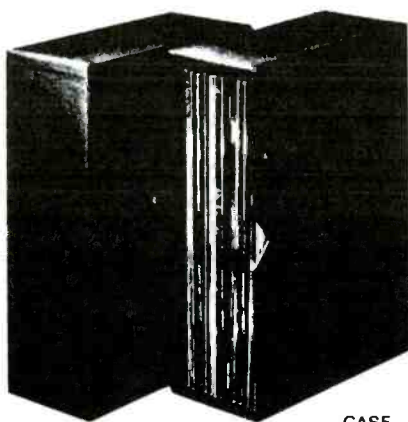

CASE

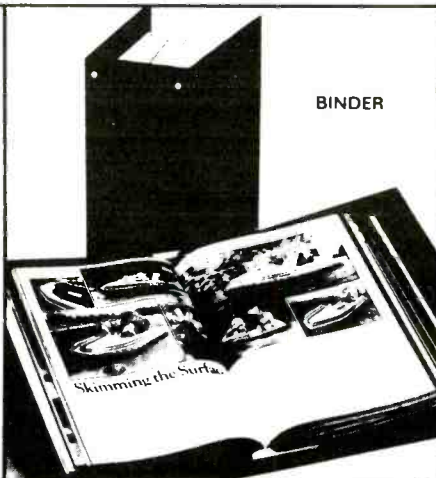

BINDER

Now there's an easy way to organize and keep copies of your favorite magazine readily available for future reference.

Designed exclusively for PC by Jesse Jones Industries, these custom-made titled cases and binders provide the luxury look that makes them attractive additions to your bookshelf, desk or any location in your home or office.

Whether you choose cases or binders, you'll have a storage system that's durable and well organized to help protect your valuable copies from damage.

- Cases and binders designed to hold a year's issues (may vary with issue sizes).
- Constructed of heavy reinforced board, covered with durable leather-like material.
- Title hot-stamped in gold.
- Free personalization foil for indexing year.
- Cases V-notched for easy access.
- Binders have special spring mechanism to hold individual rods which easily snap in. This allows magazines to be fully opened for easy readability.

Popular Communications  
Jesse Jones Industries, Dept. P-Com  
499 East Erie Avenue, Philadelphia, PA 19141

Please send \_\_\_\_\_ cases; \_\_\_\_\_ binders  
for Popular Communications Magazine.

- Enclosed is \$\_\_\_\_\_.
- Charge my: (Minimum \$15)  
 American Express    Visa  
 MasterCard    Diners Club

Card # \_\_\_\_\_ Exp. Date \_\_\_\_\_

Signature \_\_\_\_\_

Charge Orders: Call TOLL FREE 7 days, 24 hours 1-800-972-5858

Print Name \_\_\_\_\_

Address \_\_\_\_\_

No P.O. Box Numbers Please

City/State/Zip \_\_\_\_\_

PA residents add 6% sales tax

| Quantity | Cases   | Binders |
|----------|---------|---------|
| One      | \$ 7.95 | \$ 9.95 |
| Three    | \$21.95 | \$27.95 |
| Six      | \$39.95 | \$52.95 |

Add \$1 per case/binder postage  
and handling. Outside USA  
\$2.50 per case/binder. (U.S.  
funds only.)

**SATISFACTION GUARANTEED**

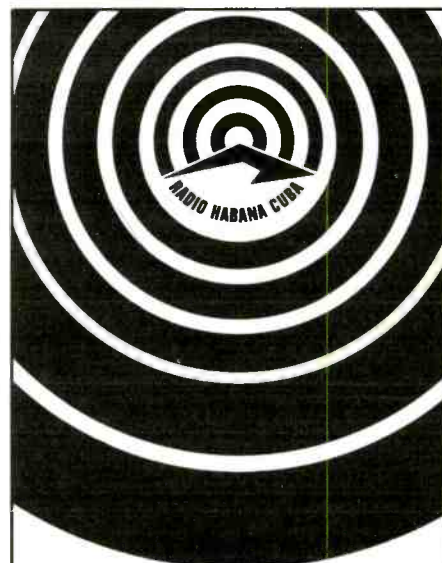

**RADIO HABANA CUBA**  
Apartado No. 7026, Habana, Cuba

*Radio Havana Cuba targets US listeners for  
several hours each day.*

The Voice of Ethiopia ("revolutionary" was dropped from the name last year—for whatever significance that may have) is enjoying some slight improvement in reception lately, again, thanks to good conditions. Try the external service on 9560 from 1400-1800 in English, French and various African languages. There's also an English broadcast to Europe at 1800 on 960 which is sometimes heard here. You can also catch the home service sign on at 0330 (in Amharic) on 7110.

**People's Republic Of Angola**—Angola became independent of Portugal in 1975 and became a people's republic, led by the Movimento Popular de Libertacao de Angola—Partido de Trabalho. Two other groups vied for power and then waged guerrilla war. Only one Unita continues the campaign and it holds much of the south. The Cubans are still deeply involved in Angola.

Radio Nacional de Angola is another station in the "sometimes you can hear them, but mostly you can't" category. The international service, such as it is, has English weekdays from 1600 (1700 on weekends) on 11955. This is followed by French at 1700 (1800) and Spanish at 2000. Portuguese programming and independently produced "liberation" programs are also on at various hours.

**People's Republic Of Mozambique** Mozambique gained independence from Portugal in 1975 after a guerrilla war. The controlling political party is FRELIMO (Frente de Libertacao de Mocambique). The economy's in bad shape and the government has to contend with a right wing guerrilla group RENAMO, the Mozambique National Resistance.

Hearing Radio Mozambique is another tough task. Exceptionally good African propagation conditions will sometimes bring in the 100 kW national network station on 3210 (usually 3211) from 0300 sign on. The external service, beamed only to southern Africa, is sometimes audible on 9618 between 1800-1900, in English. Other logs have been made on the national service with its 0430 sign on on 4865, 9618 and 11818, though very infrequently.

#### People's Republic Of The Congo

Three years after gaining independence from France in 1960, a coup brought a Marxist-Leninist government to power. Despite another coup in 1968, and presidential assassination in 1977, the various military governments have continued on this course.

La Voix de la Revolution Congolaise is rarely on the air and has not been heard in at least a couple of years. Whether this is due to equipment problems, a lack of operating funds or what is anyone's guess. If the station should come back the best shot at hearing it should be on 15190 in French and local languages. Most reports of this in the past have been during the afternoons in North America.

**People's Socialist Republic Of Albania**—After World War II the US, Britain and the USSR recognized a provincial government led by General Enver Hoxha, a communist who had been a guerrilla leader against the Axis occupation. Hoxha broke with the USSR in 1961 over de-Stalinization, swung his friendship to China (which built him his shortwave transmitters) but then dumped Beijing in 1978. Since then Albania has kept to itself. There have been some slight movements towards outside ties since Hoxha's death in 1985 and even rumors of protests against the government.

Radio Tirana—the station we love to hate—has English for North America on the air at 2300-0000 on 6120, 9760 and 11825, 0230-0300 on 9500, 9760 and 11825 and 0430-0500 on 9480 and 11825.

**Socialist Federal Republic Of Yugoslavia**—Yugoslavia was formed of several nationalist groups at the end of World War I as the "Kingdom of Serbs, Croats and Slovenes." The name was changed to Yugoslavia in 1929. Marshall Josip Tito's resistance forces battled occupying Axis powers and later other resistance groups. Tito became premier after German troops left, soon deposed the king and moved to create a communist state. He later broke with Moscow and steered his own communist course. Tito died in 1980, and since then problems have mounted, including increased ethnic unrest.

The post-Tito years have brought progress for Radio Yugoslavia, though, in the form of 500 kW transmitters which has meant better reception of the station here. English to North America airs at 0100-0145 on 5980, 6005 and 11735; 1300-1330 on 11735, 15165, 15325, 2200-2245 on 7215, 9620, 9660 and 11735.



*The Voice of Nicaragua operates on 5999v evenings and has an hour of English.*

**Republic Of Cuba**—Fidel Castro's guerrilla army overthrew the dictator Batista in 1959, after a six year campaign. Castro, hero and media star in the US at first, showed his real colors when he later adopted a Marxist-Leninist program. Castro and his Partido Comunista de Cuba still run things, despite past efforts of the CIA and various exile groups. The USSR is cutting back on its economic aid and some people believe we may see the end of Castro's government before long.

Radio Havana Cuba is in English for North America during most of our evening hours on such frequencies as 9710, 11760, 11820 and 11835. Hard to miss.

**Republic Of Nicaragua**—The Sandinista revolution, victorious over Somoza in 1979, still retains power, despite the US-backed contras. That success is due in no small measure to military support from the USSR and Cuba. The economy is in poor shape, elections are still due, the contras are hanging on despite declining US support and the 9th inning isn't here yet.

The Voice of Nicaragua has moved to a frequency just below 6000 (sometimes 5998, sometimes 5999) and operates throughout the evening hours here. There's an hour of English which, although listed for 0300, has been reported variously at 0000 and 0500.

The nations covered here may not go through the earthquake-like political upheavals which struck Eastern Europe but a loosening of the chains has to come sooner or later. Check them out while you wait. It should be an interesting game trying to hear and QSL those that are still left and monitoring the stronger signals to see if you can detect the winds of change blowing through communist microphones. **PC**

**YOU  
AIN'T HEARD  
NOTHIN...YET!**

Since 1967, CRB Research has been the world's leading publisher and supplier of unique hobby and professional books and information including:

- Scanner Frequency Guides
- Shortwave Frequency Guides
- Military/Federal Communications
- Broadcast Station Registries
- Undercover Communications
- Survival Communications
- Covert Operations
- Electronic Espionage
- Surveillance
- Monitoring
- Cryptography & Codes
- Bugging
- Wiretapping
- Communications Antennas
- Electronics & Projects
- Regency Scanner Directories
- Computer Technology
- & Other Related Topics!

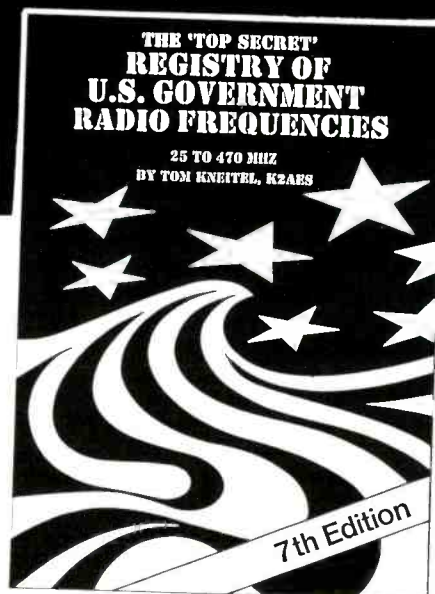

New titles are constantly being added to our exciting catalog. If it's interesting and unusual, we've got it. You'll see! Ask for our latest FREE catalog.

**CRB RESEARCH**  
P.O. Box 56      Commack, NY 11725

CIRCLE 67 ON READER SERVICE CARD

# Shortwave Mysteries

## Strange Signals From Unknown Sources Bombard Your Receiver

BY HARRY HELMS, AA6FW

**D**o you love a good mystery? I do, the shortwave bands are crawling with loads of puzzling and unusual signals that defy easy explanation. Since my last report in the December, 1988 issue of POP'COMM, several new types of unknown signals have been heard by DX'ers across North America. In addition, several mysteries reported in my earlier article are still heard and are as baffling as ever. Try your hand at hearing these signals—you might just be the SWL who supplies that one essential clue that everyone else is missing!

### The "Foghorn"

I think the "Foghorn" was so named by well-known covert radio expert Havana Moon. I'm not sure the name is entirely accurate, but I can't come up with any better description. What does the Foghorn sound like? Imagine something like Jimi Hendrix or Eddie Van Halen playing an electronically synthesized kazoo! Others have described it as being the world's most impressive video game sound effect or just an electronic "BRAAPPPP!!!" Regardless, once you hear the Foghorn, there's no mistaking it. It is usually very loud, quite raucous, varies in tone, and operates in an on/off pattern on various frequencies. Often, it will operate on two or more frequencies simultaneously. Active frequencies for the Foghorn include 5240, 5303.5, 6870, 6919, 7635, 7838.5, 7846, 7861, 7954, 11420, 11468, and 14376 kHz (although it uses others at times), and it's most commonly heard from 0400 to 0600 UTC. The typical operating sequence is about 30 to 45 seconds on, followed by 60 to 90 seconds of silence. However, by the Spring of 1990 it had also started operating continuously at times but with reduced signal strength (about S-5 or so). These continuous Foghorn signals have been heard on 6936 and 7944 kHz around 0545 UTC. Sometimes these frequencies operate simultaneously, although not in parallel.

One of the very curious aspects of the Foghorn is its habit of showing up on frequencies where other interesting radio signals can be heard. For example, in January of 1990 I caught a five-digit Spanish num-

bers station 7920 kHz being wiped out by the Foghorn around 0453 UTC. Later the same evening, I heard KKN50, the U.S. State Department's station at Warrenton, VA, having its CW marker on 6925.5 kHz heavily interfered with by the Foghorn. By coincidence (??), the Warrenton site is also known to be one from which four-digit Spanish numbers transmissions originate!

So where does the Foghorn transmit from? Several sources indicate it is—at the time of this writing—located at a site near the Managua airport in Nicaragua. With the recent electoral defeat of the Sandinistas, it may be moved to more hospitable place (perhaps nearer Havana?). What is the purpose of the Foghorn? *That is a real puzzle!* It doesn't seem to be any sort of legitimate navigation or radiolocation device, nor does it seem to be any sort of over-the-horizon radar or communications system. There's still much more to be discovered about this mystery.

### Speaking Of KKN50 . . .

KKN50 had a big surprise for me on March 4, 1990. Tuning across 6926 kHz at 0432 UTC, I noticed an open carrier on the frequency. Pausing there, I was startled to hear the KKN50 "QRA" marker, but in *tone-modulated CW* instead of pure CW! Essentially, an audio oscillator was keyed to produce Morse characters transmitted as an ordinary AM signal. But why on Earth would what is supposedly an embassy communications station use such a grotesquely inefficient method of communications? I've never heard anything like this before on any of the "KKN" stations, and I haven't heard it since.

I have a little theory as to how this might have happened, however. For several years, numerous SWL's have heard tone-modulated CW used to transmit Morse code five-digit numbers messages. As previously mentioned, Warrenton is also a transmitter site for numbers messages. Now let's suppose that one night the operators got a little careless, and instead of running the KKN50 marker tape on a CW transmitter ran it instead on one used for tone-modulated Morse messages. Of course, the KKN sta-

tions are strictly used for diplomatic communications rather than espionage work, right? *Right???*

### Numbers Station Jammed!

I caught the start of a five-digit Spanish numbers message on February 9, 1990 at 0501 UTC on 6785 kHz. The familiar female voice repeated "atencion 687 02"; signals were strong but the audio was a bit muffled. But seconds after this transmission started, a high-pitched "whine" started up on the same frequency. The whine quickly rose in volume and intensity, and changed into a sound like a badly corrupted ARQ signal. It peaked at about one S-unit stronger than the numbers station and made reception of it difficult; I could no longer copy the individual digits of the message. At 0508, the signal abruptly stopped, but there was a strong heterodyne which indicated the jamming station was still transmitting an open carrier. At 0511, the jamming resumed at the same level and continued until 0519, when the numbers transmission ended. The jamming stopped a couple of seconds later. However, there was still a strong heterodyne left.

This reception raises two interesting questions: where was the numbers station located, and who was doing the jamming?

### Weird CW Traffic

Dave White of Maine, is one of the world's leading experts at following the numerous covert CW networks that populate the shortwave bands. These networks typically pass encrypted traffic using bogus call-signs. They operate on frequencies other than those used by the U.S. military, and the sloppy operating techniques and frequent technical problems strongly point to a "non-Western" origin for these. From his location, Dave hears many signals which I can't at my southern California QTH. Dave has made several interesting recordings of unusual CW activity, and kindly let me listen in on a few.

Some very unusual signals have been showing up on 3927 and 3924 kHz during the early evening hours (from 0000 to 0100 UTC) in Maine. These consist of a single

cryptic identifier repeated continuously until it is interrupted for a short coded message, after which the identifier resumes. For example, Dave caught "E6S5" being repeated when it was interrupted by the following: "DE VIZ6 QTC 7 20 26 0205 BT 067 SFGJ BT YAJUL IQXOR EJKCA 38192 DAENV XBIDZ 98102 WJ JKA YQIMX DZHGR FJCOA WKNOX XTQFA VWRKA IRGNC 21760 94137 LGDAC SB,NW FOUCE BT VIZ6 AR". After this was sent, "E6S5" resumed. Other unusual identifiers Dave has spotted on 3927 and 3932 kHz include "3V4J," "2KAR," and "6MRJ." Dave notes that the identifier seems to change daily.

Another fascinating activity pattern noted by Dave is on 3590 kHz, where he has heard a "P" beacon in CW around 2100 to 2300 UTC. This beacon is interrupted at times for some unusual traffic. Once at 2154 Dave heard the beacon interrupted for "UMS UMS UMS 25614 16319 25614 16319 25614 16319 25614 16319," after which the "P" beacon resumed. This reception is all the more strange since "UMS" is supposedly the call sign for the Soviet Navy station at Moscow; their signals on 14171 kHz in the middle of the 20-meter amateur radio band have been heard for years. At other times, brief blocks of five-digit numbers are heard when the "P" beacon is interrupted.

Dave has some strong opinions about the so-called single-letter beacons. In particular, he feels that many of these beacons are not where such "authorities" as Klingenfuss say they are. Most of these are listed as being in the USSR, but Dave hears them at times and on frequencies where propagation between Maine and the USSR is highly improbable. For example, he reports the "K" beacon can be heard at a S-9+ level at his QTH day and night, which would be impossible if it were actually located in the USSR. Dave is of the opinion that the apparent misidentification of locations for these is not an accident, but part of a "black propaganda" effort. Finally, Dave feels these are more properly "broadcasts" than beacons, as they remind him of the traffic lists run years ago on Navy and commercial maritime communications networks.

If you can read CW either by ear or computer, give a listen for these types of networks. Dave White shows what you can uncover with patience and effort!

## Strange Dots, Strange Dashes

For several years, SWL's have been running across some very unusual "beacons" (if that's what they really are) which apparently do nothing but repeat a random sequence of dots and dashes. The dots and dashes usually have a "raspy" sound, as if there's a transmitter problem of some sort (some people have even described them as short and long "noise bursts" rather than true dots and dashes). However, these signals have

been heard for years so the effect is clearly deliberate rather than some sort of temporary equipment problem.

POP'COMM's own *Clandestine Confidential* editor, Don Schimmel, has been one of the more dedicated observers of these stations. Here are some he's recently noted:

| Frequency | Time | Signal Description |
|-----------|------|--------------------|
| 4706.1    | 0208 | 17 dots, one dash  |
| 4707      | 2155 | 6 dots, one dash   |
| 4718.4    | 0309 | 11 dots, one dash  |
| 8974.5    | 0307 | 11 dots, one dash  |
| 13256.6   | 1420 | 19 dots, one dash  |

So what exactly are these stations? Some reports have claimed these are "data transmission," but exactly what kind of data is transmitted in such a fashion is unknown. Moreover, these have been heard for fifteen years! Why not give a listen yourself and report them to Don at *Communications Confidential*?

## Hot Spots

In updating my frequency database in preparation for the next edition of my *Underground Frequency Guide*, I noticed that certain frequencies are home to a variety of unusual radio signals. These "hot spots" are now entered in my receiver's memories and I find myself quickly checking them at every monitoring session. Here's a few of them, along with what I've heard at different times and dates:

| Freq. | Signals heard  |
|-------|--|
| 3292  | Five-digit Spanish numbers by female<br>Five-letter CW groups<br>"75T/TT" repeated in CW   |
| 4475  | "P" repeated in CW<br>"645 645 645 00000" repeated in CW   |
| 6785  | Five-digit Spanish numbers by female<br>Five-digit English numbers by female<br>Five-digit Spanish numbers by male<br>Five-digit Spanish numbers by female<br>3/2-digit English numbers by female<br>Five-letter CW groups |
| 6840  | 3/2-digit Spanish numbers by female (AM and USB)<br>3/2-digit English numbers by female<br>Five-digit English numbers by female<br>Four-letter CW groups<br>Five-letter CW groups  |
| 7380  | Five-digit Spanish numbers by male<br>Five-digit Spanish numbers by female<br>Five-digit English numbers by female<br>Five-digit German numbers by female<br>Five-letter CW groups   |
| 7410  | Five-digit Russian numbers by female<br>3/2-digit English numbers by female<br>Five-letter CW groups   |

Naturally, not all these different languages and modes can be heard every night. Sometimes the activity changes nightly, while in other cases it changes over a longer time period. This listing isn't exhaustive by any means; plenty of other frequencies are home to two or more types of unusual activity. The variety of different languages and modes used makes me wonder if frequencies such as those above are

## SUPERCHARGE YOUR RECEIVER!

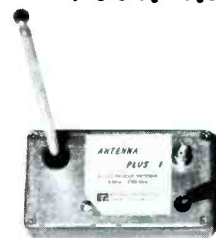

ANTENNA PLUS

Finally hear those rare stations you've been reading about! Make your receiver spring to life! Big antenna performance from a tabletop box. Models for ALL BANDS, SCANNER or SHORTWAVE. Brings in the weakest signals with an internal amplifier! Choice of BNC, UHF, PHONO, F connectors. (please specify)  
ANTENNA PLUS-1 0.5-1300MHz "All Bands" (for wide coverage rxvrs.)  
ANTENNA PLUS-2 0.5-30MHz "Short-Wave" (peaked for SWL's)  
ANTENNA PLUS-3 30-2000MHz "Scanner" (peaked for VHF-UHF)  
SPECIAL INTRODUCTORY PRICE \$79.95! (reg \$89.95)



SUPER VAK-TENNA  
Only \$149.95

Pull in the weak ones with this amplified SHORT-WAVE and SCANNER antenna. Compact and easy to mount with a 15-22DB amplifier built in. Mounts with SUCTION CUPS! Receives 0.5-800MHz like a large outdoor antenna. Also available. MAST MOUNTED version SUPER-VAK-TENNA-MM \$149.95!

Only \$34.95



### SUCTION CUP MOUNT VAK-TENNA!

IDEAL FOR APARTMENTS, OFFICES OR RV'S  
Mount to your window for the BEST SCANNER coverage! Cups hold for months! Great reception in apartments. Landlords love it! Telescopes to 79" folds to 12". 30-500MHz Choice of BNC, PL259, F or Motorola connector. (specify when ordering)

### TAPE SAVER

TS-1 \$59.95

Eliminates dead time on your scanner tapes!

Listen to an entire nights scanning while driving to work! Interfaces scanner to your tape recorder for ACTION ONLY recording.



### SIGNAL INTENSIFIERS

Make your antenna come to life!

RFP-40 1-1300 MHz! 15 DB GAIN! \$69.95



STRONGER SIGNALS for scanners, shortwave, AM-FM-TV, cable and more. 115VAC pwr. Choice of BNC, SO239 (PL259 mate) and F connectors. Battery or DC powered, remote mounted versions available. Some priced from \$34.95!

### CB INTENSIFIER

Only \$49.95

Improve your CB's range! The RFR boosts received signals by 13db! Internal T/R relay 12VDC pwr. (AC pwr add \$10)



SSB Version \$64.95  
MARINE-VHF version \$99.95

### INTERFERENCE FILTERS & ACCESSORIES

SCANNER FILTER HPF-1 (passes above 45 MHz) \$8.95; SHORT-WAVE FILTER LPF-1 (passes below 50 MHz) \$19.95; ANTENNA SWITCH AS-3 3 position \$14.95; VARIABLE ATTENUATOR VA-20 \$12.95

SEND FOR FREE SPECIFICATIONS!

### NEW SCANNER ANTENNA!

Scanner Stick rugged outdoor antenna. Intro Price \$29.95! Covers 30-1000MHz. 35" long and fully assembled. SO239/UHF Conn.

Continuum US shipping/handling \$4; AK, HI, PR, Canada \$7  
NY and MI residents add local sales tax.

**EP** ELECTRON PROCESSING, INC.  
P.O. BOX 68  
CEDAR, MI 49621  
616-228-7020

SATISFACTION GUARANTEED!

Order any product (except software) from EPI and if not satisfied return it within 15 days for a full refund (less shipping/handling)

CIRCLE 46 ON READER SERVICE CARD

being used for "real" (whatever that means) messages or are actually used for training purposes? Regardless, if you detect something unusual on a frequency, keep checking it a different times and on different nights —you might be surprised at the patterns you'll discover!

### Time Signals?

I and other SWL's keep running across pseudo-time signal stations which I've dubbed "pulsers." These stations differ from most conventional time signal stations in that they transmit pulses of unmodulated carrier. Also, these stations aren't listed in the ITU master files or other frequency list, and no government or organization will step forward to take responsibility for them.

One signal I've heard a few times is on 7516 kHz, usually around 0600 UTC. This one sends burst of unmodulated carrier at the rate of 90 pulses per second. The signal is typically loud in southern California, peaking at +20 dB over S9. I've heard similar signals on 8270 kHz around 0645 UTC. Another strong signal can sometimes be found on 20490.5 kHz around 1700 UTC. This one transmits a pulse each second, and it seems to stay in perfect step with WWV.

### A Greeting . . .

Many DX'ers interested in numbers sta-

tions, pirate broadcasters, and related radio mysteries get together for weekend "teleconferences" on the Portal computer telecommunications system. Portal allows those equipped with a personal computer and modem to connect together across the nation for "live" DX'ing of numbers stations and pirates. We are able to exchange information about what we're each hearing, and it allows us to have dozens of ears on frequency if something unusual is spotted. Among those often found on Portal are such fans of radio mysteries as Havana Moon, John Fulford, Zel Eaton, Kristin Kaye, and myself. Apparently, some of those behind unusual radio activities also check in without our being aware of it.

On March 18, 1990, several of us were jointly monitoring 6697 kHz around 0545 UTC. This is a frequency used by the U.S. Navy for USB voice traffic along the Atlantic coast. Our attention was drawn to it by the presence of two stations exchanging random groups using tone-modulated CW. Mixing with these was a male voice in English calling another station. Judging by the callsigns used (Alpha Niner Quebec, Two Foxtrot Echo, etc.), the voice traffic was U.S. Navy. The station being called in USB voice did not respond, and the operator at the calling station became increasingly frantic with each unanswered call. Meanwhile, the tone-modulated CW continued on fre-

quency, with one station beginning to send "VVV VVV VVV VVV VVV VVV DE MKL MKL MKL" continuously.

Needless to say, this unusual scene had all of the Portal crowd soon tuned on 6697 kHz. I was listening in San Diego, as was Havana Moon in southern Florida, Zel Eaton in Missouri, and Kristin Kaye in New York. Moments before 0600, the USB voice traffic and two Morse stations abruptly went silent. And then we heard it . . . a male voice, clearly and distinctly saying "Hello, to everyone on Portal!"

Nothing more was heard until 0602, when "MKL" resumed along with what seemed to be some CW time pips. Despite keeping a close watch on the frequency, we never heard our "greeter" again.

Who was it? We have no idea. Perhaps it was a member of our network who had a transmitter capable of operation there and decided to hoax us. Maybe someone has a friend in the Navy and decided to play a little trick. Or maybe someone just wanted to let all of us on Portal know that they know what we're up to.

Probably we'll never know the answer to this riddle. But it remains one of the most electrifying moments of my DX'ing "career," and is an example of what makes this entire covert radio business so fascinating! Why not see what puzzles you can unearth tonight on your receiver?

PC

# POPULAR COMMUNICATIONS

Here's what you've been looking for — an all new hard-hitting monthly magazine which gives a unique insider's view of what's really going on in the world of communications. POP' COMM is your primary source of information — bigger and better than any communications magazine, with exciting coverage of scanners, shortwave broadcast & utility stations, spy stations, pirate and clandestine broadcasters, RTTY monitoring, survivalist communications systems, FCC news, wiretapping and bugging, voice scrambling/unscrambling, surveillance/undercover communications, satellite & cable TV, sophisticated telephones, & more. What you've been looking for all along! Take advantage of substantial savings over the newsstand price by subscribing now. Don't miss out on even one single issue of POPULAR COMMUNICATIONS — order your subscription now.



Twelve Issues \$19.95

## POPULAR COMMUNICATIONS

76 N. Broadway, Hicksville, NY 11801

Yes! POPULAR COMMUNICATIONS is just the magazine I've been looking for. Start sending it to me now! I understand that I may cancel at any time for any reason, and receive a full refund on my unused subscription.

- 1 year - 12 issues \$19.95
- 2 years - 24 issues \$38.00
- 3 years - 36 issues \$57.00

Paid by:  Check  Money Order  MasterCard  VISA

My account number is:

|  |  |  |  |  |  |  |  |
|--|--|--|--|--|--|--|--|
|  |  |  |  |  |  |  |  |
|--|--|--|--|--|--|--|--|

Name \_\_\_\_\_

Street \_\_\_\_\_

City \_\_\_\_\_ State \_\_\_\_\_ Zip \_\_\_\_\_

Canada/Mexico—one year \$22.00 US, two years \$42.00 US, three years \$63.00 US; Foreign—one year \$24.00 US, two years \$46.00 US, three years \$69.00 US; Foreign Air Mail—one year \$77.00 US, two years \$152.00 US, three years \$228.00 US.





# Amateur Radio 1990 Buyer's Guides

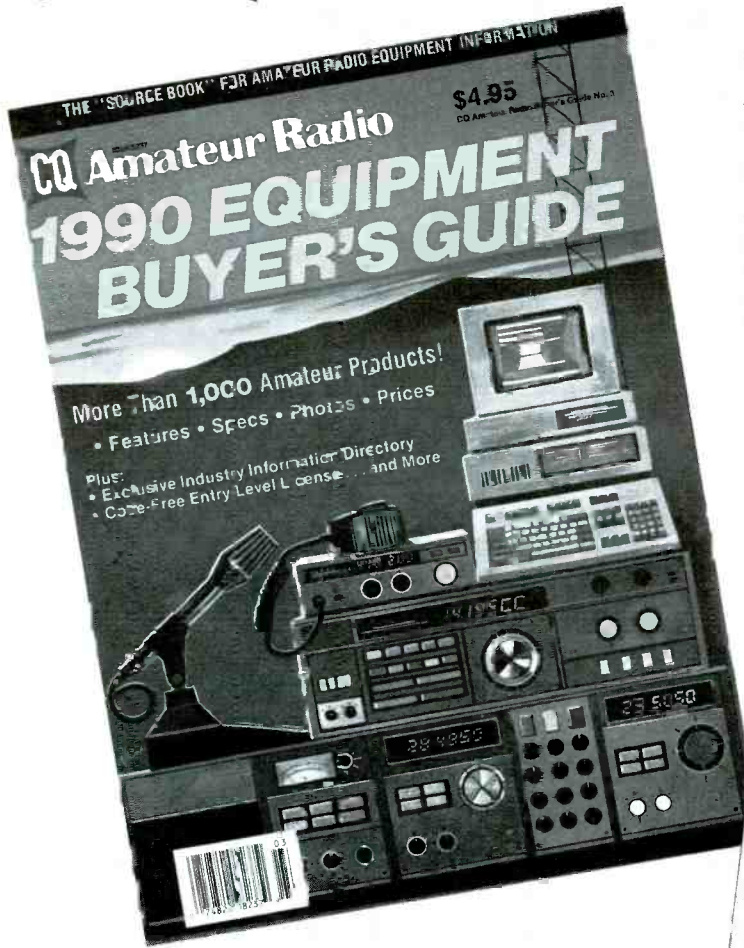

The **Equipment Buyer's Guide** gives you the edge in selecting just the right equipment for the shack, whether it be HF or VHF/UHF rigs or accessories. All the information is here in one handy, concise directory with descriptions, technical specifications, model numbers, retail prices and photographs. What do you do to get a license? How do you put a packet station on the air? What transceiver features are important to DXers? What equipment will you need for the new code-free license? These questions and more are answered in feature articles. Buy with confidence when you make your decisions based on all the facts.

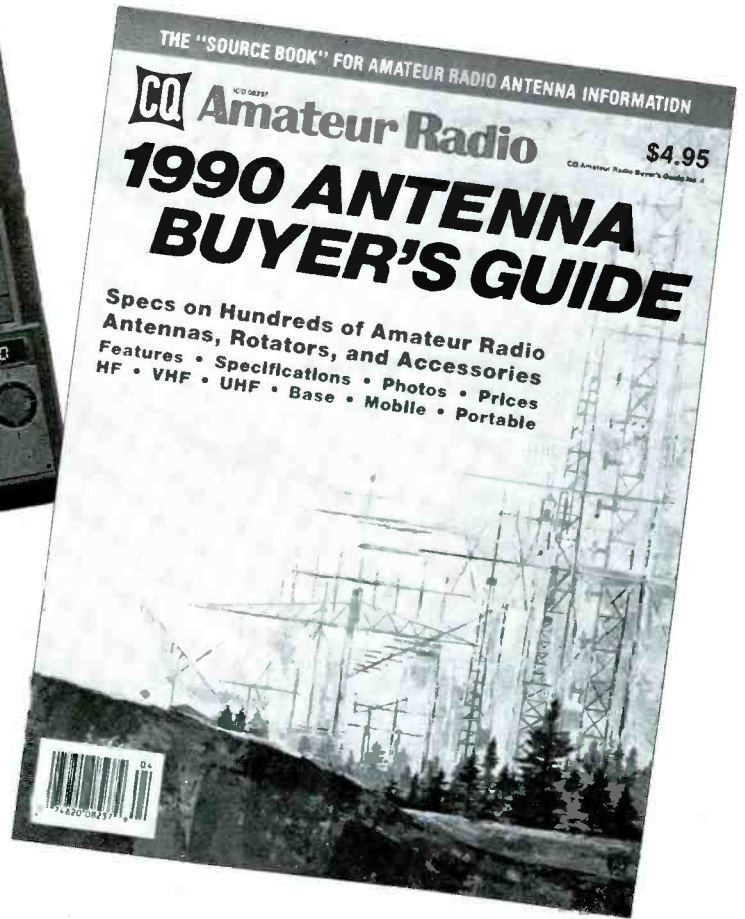

You'll need the **Antenna Buyer's Guide** to squeeze every last dB out of your antenna dollars. Make sure you get the best possible antenna system for the best price! HF and VHF/UHF, directional and omnidirectional, vertical and horizontal, mobile and portable—they are all covered in depth. Tuners, cables, wattmeters and more! You'll find detailed charts, specifications, photos and retail prices. Advice on getting the proper tower and antenna permits from a leading authority on PRB-1. Step-by-step guide to putting up your first beam! The bands are hotter than ever right now. **You can't afford to wait.**

## ORDER YOUR BUYER'S GUIDES TODAY!

Don't miss the most valuable buying guides in the Amateur Radio field!

YES, please send me \_\_\_\_\_ copies at \$4.95 each:

- EQUIPMENT BUYER'S GUIDE  
 ANTENNA BUYER'S GUIDE

Name \_\_\_\_\_ Call \_\_\_\_\_

Address \_\_\_\_\_

City \_\_\_\_\_ State \_\_\_\_\_ Zip \_\_\_\_\_

Send only \$4.95 each today. Foreign: \$6. U.S. funds.  Check  Money Order

MasterCard  VISA  Amex Card No. \_\_\_\_\_ Expires \_\_\_\_\_

Signature \_\_\_\_\_ (required on all charge orders)

Mail to: CQ Communications, Inc., 76 North Broadway, Hicksville, NY 11801/FAX: 516-681-2926

# Skip Is Bustin' Out All Over!

## Scanning From 25 MHz To Over 1000 MHz Can Reward You With DX In August

BY CHUCK ROBERTSON

**I**t's summer, and the skip is rolling through. DX signals in the 25 to 50 MHz band may be familiar to you, but right now you can look for them to pop up on occasion on frequencies as high as 1000 MHz. All you need is a scanner with a good outside antenna. Pour yourself an icy glass of fresh lemonade; you're all set.

Tropospheric ("tropo") propagation accounts for most of the summertime DX you'll pick up between 50 and 300 MHz. While there are several types of tropo, inversion layers are of primary interest to scanner DX fans.

Normally, in the summertime, it's warm at ground level, but if you were to measure the temperature aloft, you'd see how much cooler it is there. That's why people head for the mountains in the summer. Inversion layers result when this system goes topsy-turvy and a warm air mass rides in and sits on top of cooler air. When this happens, some radio signals are refracted (bent) back towards earth when they encounter the mass of warm air.

During calm summertime weather, inversion occurs almost every day from evening to mid-morning. Skip distances of 400+ miles are common. Where I live, in southern Illinois, I regularly scan the Kansas City Police Dept. on 154.71 MHz, and can pick up VHF high band and UHF stations from Chicago. Broadcast TV signals arrive here from Cincinnati, Nashville, St. Louis, and elsewhere for many evenings of late night entertainment.

Massive inversion layers produced from slow moving weather systems can produce DX stations from more than 1,000 miles away. They occur at any hour and can last for several days. That brings me to the Mexican Federal Highway Police on 154.70 MHz, 154.73 MHz, and elsewhere.

Hot, sultry high pressure areas can be outstanding sources of tropo. For instance, monitors on the East Coast can count on the Bermuda High effect to offer some truly great summer DX.

Frequencies below 50 MHz aren't much affected by inversions. Luckily, there will be lots of Sporadic-E this summer and that will bring in DX between 25 to 100 MHz, with skip from 400 to 1,300 miles (2,500+ miles

multi-hop). Check for Sporadic-E at any hour, although early evening and mid-morning are best bets.

### VIP DX

I knew something unusual was going on. Military operators on 32.10 MHz were exchanging stories about the tight security measures they had been enduring in recent days. Tarantula-5 asked someone, "Did they frisk you?"

Cobra-15 replied, "That's an understatement. They even tore apart our *hummers*. Took my propane tank and a whole bunch of stuff—even searched the Thermos and our coffee mugs and everything else."

Lizard-3 broke in and asked, "You know that people can listen to this, don't you?"

Cobra-15 wanted to know, "You mean real people, or us people?"

Lizard-3 explained, "Those people! The Secret Service agents are probably having a good laugh."

Tarantula, Cobra, and Lizard were waiting in their hummers (Jeeps) to escort the President of the U.S. around Fort Irwin National Training Center in southern California. After arriving at a command post atop the Siberian Ridge, the President watched our forces engage 160 mock Soviet tanks at a location with the eerie name of the Valley of Death. In the end, the *Krasnovian* tanks proved to be too much for forces. The war games were copied on 30.35, 31.90, 32.15, 32.25, 32.95, and 33.05 MHz.

On 30.30 MHz, top Ft. Irwin brass were still hashing out details of a welcome speech to be given to the President. Vulture-23 wanted to know, "Do I need to say something to the President when he's through with the presentation?"

A few minutes later, the President interrupted the war games to give his speech. All of the 7,000 troops halted in their (tank) tracks to listen. The President didn't need to speak loudly, the speech was broadcast on 30.30 MHz.

The President's speech was brief, but a real rouser that thanked them for giving him the opportunity to witness their maneuvers and congratulated them on their leadership and fighting spirit. The speech concluded

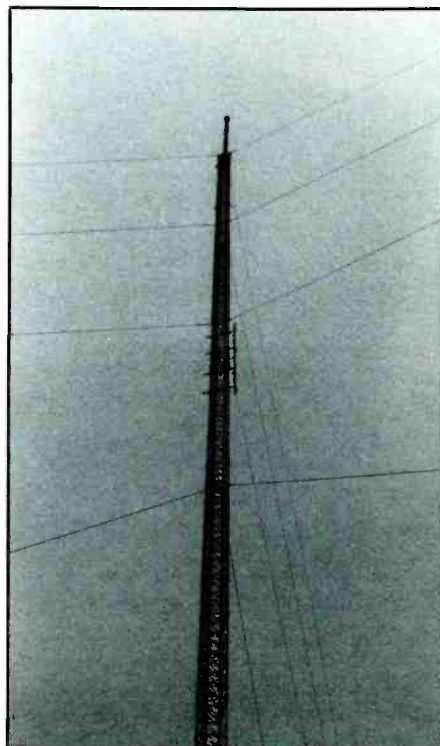

Some paging stations repeat NOAA weather broadcasts. NOAA station WXM49 (162.425 MHz) uses the antenna side-mounted midway up the tower of TV station WTCT in Marion, IL. The tower is near Goreville, IL.

with the words. "Thank you, Colonel. And now, back to war!"

Back on 32.10 MHz, Tarantula-5 asked Cobra-15, "Were you listening to thirty-thirty?"

Cobra-15 replied, "Yeah—and do I feel patriotic!"

Not all communications relating to the President take place on Secret Service or White House channels. Keep it in mind.

### Border Mysteries

Recently, I've been following some old federal comms involving "target" individuals who are being tracked rather relentlessly.



The President's speech put the wargames on "hold" for a few minutes, but then it was business as usual. Heard it all via skip on my scanner. You can, too!

ly by agents from one agency or another. The traffic goes something like this, "Track update: Still heading west at Licorice 99'er. Now at Mexico 25, heading northwest. Designation Charlie 11 tagged at Lettuce 6."

Another intercept: "Update Track 7. Now heading northwest at Kettle 51—scrub track." Other locations mentioned include Yellow, Dolphin, Kennel, Jersey, Jello, Kentucky, Baseball, Devil, and Elbow.

These comms have been intercepted on 32.25, 33.25, and 37.85 MHz. It seems the channels are changed often and I've never heard the same frequency used twice.

Once, I heard an exchange of comms that wasn't buried in code words. It gave me a possible clue as to what might be going on. Two personnel on 32.25 MHz were making plans, "We'll take two roads, one on the US side, the other on the Mexican side." One of the operators sounded like an American, the other had a heavy Spanish accent. That led me to believe that this may be a border surveillance operation for illegal aliens or illicit drugs. Or what?

### Remember Pearl Harbor?

In the May issue, I reported monitoring 32.45 MHz and hearing offshore naval vessels near Pearl Harbor, HI engaged in sending divers to the bottom to remove old WWII bombs left scattered on the ocean floor. After additional monitoring of these comms, it appears that this operation is less localized and much larger and far ranging than I first reported to you.

The vessels travel throughout the Pacific between Hawaii and California. Could they be roving EOD troubleshooters, dispatched to areas where bombs, missiles, torpedoes, and other ordnance has recently been fired or launched, or otherwise lost in the drink and needs to be retrieved for security or safety purposes? Maybe the work of the Pacific Missile Test Range? Any ideas?

Some of the ID's monitored include: Nav Control, Dive Boat, Snare Drum Delta, Snare Drum Echo, Snare Drum-51, Transport, Fairground, Super Bowl, EOD Boat, ITC, Seaco Boat, and a helo that ID's as Hurricane.

## HAM RADIO IS FUN!

It's even more fun for beginners now that they can operate voice and link computers just as soon as they obtain their Novice class license. You can talk to hams all over the world when conditions permit, then switch to a repeater for local coverage, perhaps using a transceiver in your car or handheld unit.

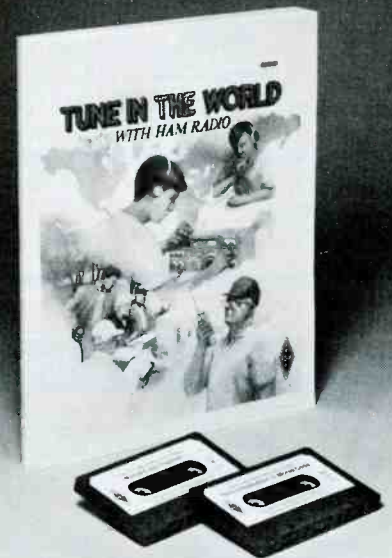

Your passport to ham radio adventure is TUNE-IN THE WORLD WITH HAM RADIO. The book tells what you need to know in order to pass your Novice exam. Two cassettes teach the code quickly and easily.

Enclosed is my check or money order for \$19.00 plus \$3.50 for shipping and handling or charge my

VISA  MasterCard  Am. Express

Signature \_\_\_\_\_

Acct. No. \_\_\_\_\_

Good from \_\_\_\_\_ Expires \_\_\_\_\_

Name \_\_\_\_\_

Address \_\_\_\_\_

\_\_\_\_\_

City \_\_\_\_\_ State \_\_\_\_\_ Zip \_\_\_\_\_

PC

**THE AMERICAN RADIO RELAY LEAGUE**  
225 MAIN ST.  
NEWINGTON, CT 06111

CIRCLE 41 ON READER SERVICE CARD

## Pirates, Ahoy!

A recent FCC survey conducted in four cities revealed that 8% of land mobile stations in Atlanta didn't have licenses, 13% in New Orleans, 25% in Houston, and 40% in Los Angeles. Searching out these unlicensed radio systems on your scanner can be thrilling. Which stations are legit, which are bootleggers?

Monitors located near waterways should be able to snag illegals on VHF high band frequencies adjacent to marine channels. I often hear barges on the Mississippi River whose captains chatter away on 156.15, 156.175, 156.200, and 156.225 MHz. These are police frequencies, but I guess that the barge people aren't too worried about being pulled over by an irate county mountie.

In a case of turnabout, some land stations show up unexpectedly on marine frequencies. During a vacation to the Grand Bahama Island, scanner owner Richard Stein found that the Xanadu Beach Hotel in Freeport uses 156.925 MHz for their security patrols. This is Marine Channel 78.

Security at the airport in Mexico City is on 156.85 MHz, which is Marine Channel 17. Mexico City is inland and the presumption is that there is little chance of causing interference.

With the low cost and easy availability of

## Some Active Mexican Frequencies To Watch in July

**31.85:** Repeater out (32.20 in). Judicial & State Police. Judicial Police are a federal investigative agency.

**138 to 144:** Mobile phones. Common base/mobile pairs: 143.575/-138.315; 143.70/138.44; 143.80/138.54; 143.90/138.64 MHz.

**144 to 148:** The 2 meter ham band. In Mexico there are more businesses pirating here than there are licensed hams.

**148.30 & 148.50:** Ensenada Police Department.

**149.775:** Sonora Police Department.

**150.90:** Cuernavaca Police Department.

**151.30:** Tlaxala Police Department.

**151.40 & 151.46:** Tijuana Police Department.

**151.625:** Repeater out. Mexican Navy, Acapulco.

**152.84, 154.70, 154.73, 154.76, 154.79, 172.00:** Federal Highway Police. Used widely throughout Mexico.

**152.875 to 153.60:** Remote broadcast pickup.

**156.05 to 157.40; 161.475 to 162.45:** Marine, business, police.

**157.70:** Sonora Light & Power Company.

**161.175:** Repeater out. Dept. of Agriculture, area of Heroica Caborca.

**163.575:** US Consulate General, Baja.

**165.325:** Repeater out (166.275 in). Mexican Customs Service.

**166.125, 166.30, 166.425, 166.525, 166.65:** Baja California Police Department repeaters.

**216 to 220; 225 to 229:** Studio-to-transmitter links.

**229 to 243:** Rural radiotelephones.

**243 to 252:** Subscription background music services.

**311 to 335; 406 to 420:** Point-to-point telephone links (multiplexed).

## Improve Your World Image



## PC HF FACSIMILE 4.0 \$99

A complete facsimile reception system for the IBM PC or Compatible. Receives up to 16 intensity levels.

### Includes:

Demodulator Software  
80 Page Manual  
Tutorial Cassette  
Frequency List  
Interpretation Guide

### Features:

Print on Epson, or HP Laser Jet  
Disk Save, Zooming, Image processing  
Unattended Image Capture and much more

## PC GOES/WEEFAX \$250

Designed to receive images directly from U.S. and Soviet meteorological satellites. Includes all of the above feature plus a complete orbital tracking system and resolution of up to 256 gray levels.

## Software Systems Consulting

150 Avenida Cabrillo, "C", San Clemente, CA 92672  
(714)-498-5784

CIRCLE 42 ON READER SERVICE CARD

synthesized handheld, mobile, and base station transceivers, it's not surprising that they are put to many uses that are somewhat unusual.

An east coast communications company has been spotted running a duplex phone base on the weird frequency of 30.10 MHz. ID's include Wildwood, Collins Lake, Reamcore. Once they said, "It's a Berlin number." Might be in New Jersey.

Another illegal radiophone system is in California on 35.46 MHz (base), 43.46 MHz (mobile). Yes, I know that this one is (or was) a standard mobile phone frequency pair at one time. In 1988, the FCC phased out these allocations and turned over all of the base and mobile phone channel to paging services.

A seemingly illegal private mobile is in the Chicago area running the base on 35.34 MHz and mobiles on 43.34 MHz. Maybe there's a lot of old equipment floating around in the used market.

One exception to the FCC's allocations change seems to be KOP303, a legal mobile phone service near Seattle, WA. It's an active station and a CW ID is given after each completed phone call.

## A Puzzlement

Recently, I received a letter from John F. Combs, Jacksonville, FL. He reports hearing NOAA 162 MHz weather broadcasts over a paging station during a skip opening.

He wrote that while tuned to 35.22 MHz he recognized the NOAA transmission and heard it identify as KHB59 on 162.55 MHz in Cleveland, OH. Not long after, the same frequency produced KIH35 in Pittsburgh, PA which was long supposed to be operating on 162.55 MHz.

John's thoughts were that if it's a practical joke, it's a doozie. Or, if there is some logical explanation, he'd like to be let in on that news.

It certainly appears that what John picked up is known as an ancillary broadcast. That means, on weekends, after-hours, or at other times when radiopaging operations aren't taking place, a paging station might run the NOAA weather transmissions, automated time announcements, fed through the phone company's recorded sports update, etc.

The NOAA weather reports fed through on 35.22 might well have been for the benefit of disaster agency personnel watching the progress of thunderstorms in their area. Pagers capable of picking up voice paging during the workday serve double-duty as weather radios when used in this manner. Paging stations aren't all beeps, they offer some interesting monitoring and DX possibilities that have not yet been discovered by many monitoring enthusiasts.

Well, this is the month to cool off with some hot tropo DX. Let me hear from you with your DX catches. Write to me at POP'COMM.

PC

# NEW PRODUCTS

## REVIEW OF NEW AND INTERESTING PRODUCTS

### Receiving Processor

New from Curry Communications is the ANB-1089 receiver processor—a continuously tunable balanced preamplifier providing 20 dB of gain from 10 to 450 kHz. The preamplifier is switchable to allow the user the choice of a flat response or amplified output for use with a loop or other low gain antenna. Using the highly selective ceramic filter of the preamplifier, the user can adjust the lower or upper passband response; thereby alleviating the possibility of overload from strong adjacent signals. This feature also allows the user to shift the I.F. to improve receiver passband characteristics.

Perhaps the most useful feature of the ANB-1089 signal processor is the automatic noise blanker which can effectively remove strong man-made noise and improve static conditions anywhere within the 10 to 450 kHz preamplifier range. In actual field tests in urban environments, the ANB-1089 noise blanking section provided complete elimination of multiple strong noise sources such as light dimmers and power line discharge, this noise varied greatly in amplitude and frequency. During nighttime tests, evening static conditions were suppressed, thereby eliminating receiver overload. The frequency of interest remained quiet enough to complete 24 hour reception of LF beacon "H2," received at a distance of over 100 miles. The automatic blanker features balanced circuitry for reduced intermodulation



distortion (IMD), and can be adjusted manually for the desired blanking level.

Features of the ANB-1089 include:

Selectable 20 dB gain preamplifier.

I.F. shift for adjustable passband response.

Automatic noise blanking, threshold adjustable.

Complete coverage from 10 to 450 kHz.

Low pass filtering removes broadcast interference.

Connection for oscilloscope monitoring of noise blanker.

Ruggedly built.

Small enough for portable use (uses standard 9 volt battery).

The ANB-1089 is available for \$92.00 (Postage-paid) from Curry Communications, 852 North Lima Street, Burbank, CA 91505, or circle 103 on our Readers' Service.

### New Hand Held Receiver Offers Continuous Coverage and 100 Channels

ACE Communications has announced the introduction of a new 100 channel hand held receiver with continuous frequency coverage from 25 MHz to 550 MHz and 800 to 1300 MHz.

The frequency coverage of the unit allows reception of civil and military aviation bands plus all public service bands. AM or narrow FM reception modes are selectable at any frequency.

A suggested retail price of \$499 has been set for the unit, which includes a 120 volt to 12 volt wall plug adapter/charger, fused DC cigarette lighter plug charger cord, telescopic antenna in addition to a carry case and AA size rechargeable batteries.

The new radio is extremely compact, measuring 7" in height, 2½" in width, and 1½" in depth and weighing 13 ounces. Actual measured sensitivity of the unit exceeds .4uV and 12db Sinad in narrow FM mode and 1.0uV at 10db S/N in AM mode.

Twenty front panel keys allow programming of the 100 total scan memory channels. Pairs of upper and lower limits for bands to be searched can be stored in 10 separate search memory locations. All information is stored in RAM backed up by a long life lithium battery. Extra features include selectable single channel priority, keyboard lockout, BNC antenna connector, and a display backlight for night use. The LCD display itself offers 22 separate prompting annunciators to aid the user in operating the unit.

An additional unique feature of the unit is the energy saving "Sleep" mode. In this mode the computer will actually power down all operating circuits and actually display the word "Sleep" on the display, only periodically powering up to check for active transmissions.

For additional info, write ACE Communications, Monitor Division, 10707 East 106th Street, Indianapolis, IN 46256. Or circle 108 on our Readers' Service.

# YOU AIN'T HEARD NOTHIN'..YET!

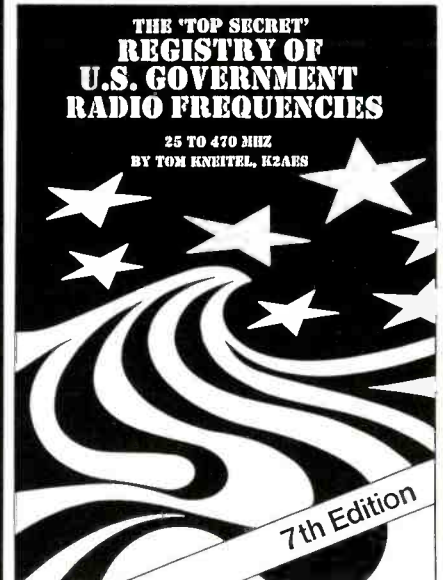

Since 1967, CRB Research has been the world's leading publisher and supplier of unique hobby and professional books and information including:

- Scanner Frequency Guides
- Shortwave Frequency Guides
- Military/Federal Communications
- Broadcast Station Registries
- Undercover Communications
- Survival Communications
- Covert Operations
- Electronic Espionage
- Surveillance
- Monitoring
- Cryptography & Codes
- Bugging
- Wiretapping
- Communications Antennas
- Electronics & Projects
- Computer Technology
- & Other Related Topics!

Ask For Big Free Catalog!

New titles are constantly being added to our exciting catalog. If it's interesting and unusual, we've got it. You'll see! Ask for our latest FREE catalog.

**CRB RESEARCH**

P.O. Box 56 Commack, NY 11725

CIRCLE 68 ON READER SERVICE CARD

# POP'COMM REVIEWS

## Software Systems Consulting's PC SWL Program

**I**t was only a matter of time when a low cost PC-based CW/RTTY reader would become available. Thanks to Software Systems Consulting, (150 Avenida Cabrillo, Suite C, San Clemente, CA 92672) that time is now. When John Hoot of SSC asked me if I would like to take a look at his new PC SWL program, I jumped at the chance. The new program and its related hardware utilizes the latest in DSP (Digital Signal Processing) techniques.

How does it work? Very well, especially considering the price of only \$99! PC SWL includes the program disk, the hardware demodulator interface to your receiver, a tutorial with sample digital signals on a standard cassette tape, and an extensive and well written 80-page user's reference manual which includes appendices with World Press, CW, and SITOR frequencies.

The capabilities of the PC SWL program are substantial. It will copy CW from 3 WPM to 100 WPM (dependent on the microprocessor used in your PC), plus Baudot RTTY signals from 45 to 100 Baud with practically

any shift. It copies ASCII signals from 75 to 300 Baud, plus SITOR/AMTOR SELCAL (SElective CALling) and Mode B or FEC (Forward Error Correction). The latter feature also includes NAVTEX, a recent variation on FEC used by the U.S. Coast Guard to send maritime bulletins.

### **But Wait, There's More . . .**

Other features include: a tuning scope, a digital scope, auto calibration and code recognition (automatic signal analysis), continuously tunable filter frequencies, variable shift for RTTY, adjustable CW filter sensitivity (threshold), Farnsworth code compatibility, unattended capture and printing, and several DOS (Disk Operating System) file utilities. Overall, quite an impressive package.

### **Installation . . .**

The minimum equipment requirements include an IBM-compatible computer (preferably one with a 80286 or 80386 microprocessor, but one with an 8088 processor

will still work) with a minimum of 384KB of RAM (Random Access Memory), practically any video graphics adaptor board and its associated video monitor, at least one serial port, and MS DOS Version 2.1 or higher. And, of course, your shortwave receiver! Simply plug the hardware demodulator interface serial plug into the computer's serial port and the other end of the cable to your receiver's audio output jack.

Once this is done, you are instructed to load the software, either by using a working copy of the master program disk or by installation on a hard disk drive. You will be guided through the hardware installation by a very user friendly menu. In fact, the entire PC SWL program is menu driven. Installation and operation of the system, thanks to the menu driven features and the use of the computer's function (F) keys, couldn't be easier. When you have successfully connected the computer to the receiver and installed the PC SWL program, you are ready to listen in on the exciting world of digital communications!

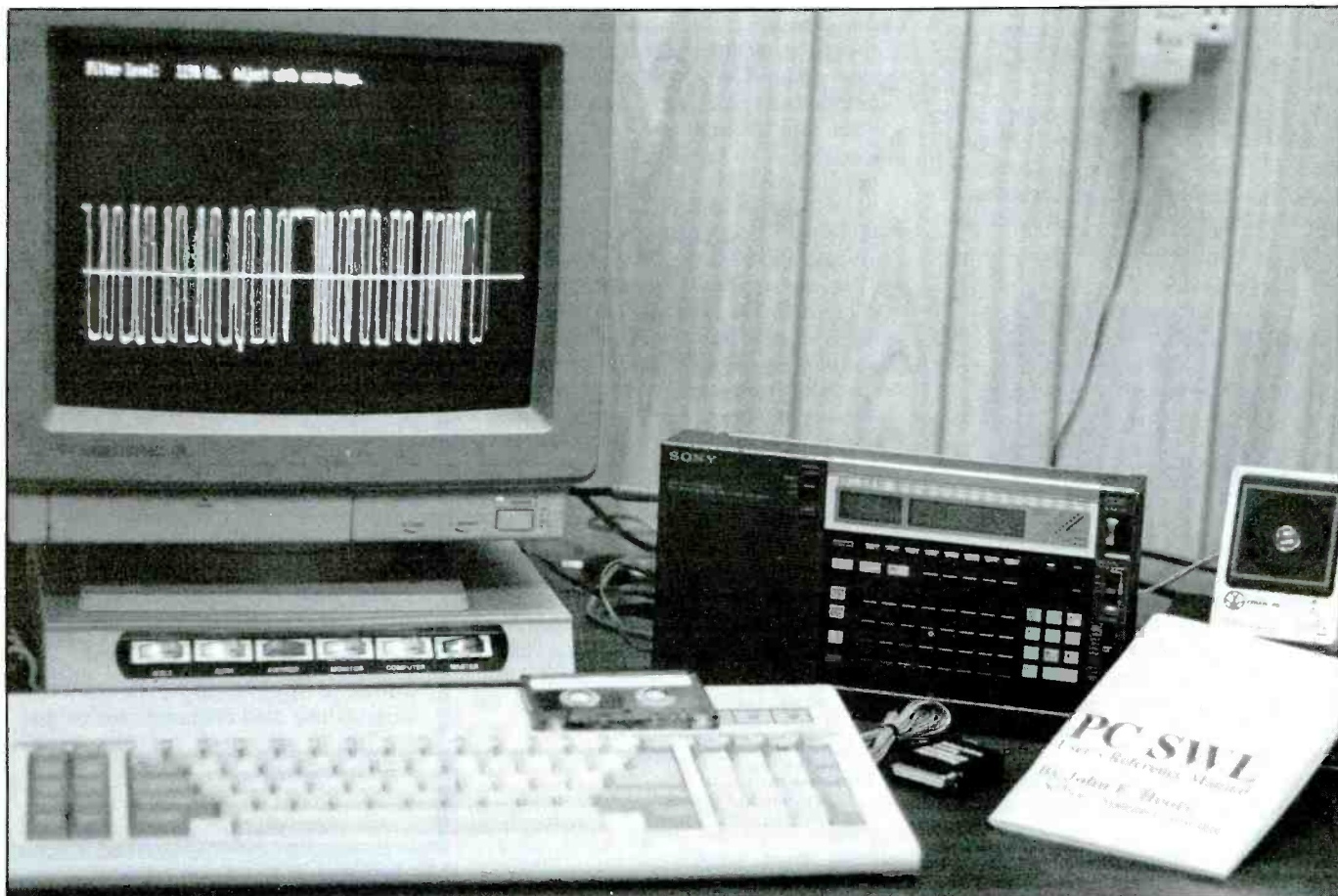

The screen depicts RTTY signals using the built-in tuning scope. The CRT screen says: "Filter Level: 1190 Hz. Adjust with arrow keys."

```

===== PC SWL [V2.0A] =====
(C) 1990 by Software Systems Consulting. All rights reserved.

Enter Selection ----->

----- Data Options -----
R) eceive Teletype
M) orse Code Reception
T) uning Scope
D) igital Scope
C) W Threshold
A) utomatic Signal Analysis
----- Buffer Operations -----
E) rase Text Buffer
V) iew Text Buffer
L) oad Text Buffer
W) rite Text Buffer
P) rint Text Buffer
----- Misc -----
F) iles Directory
S) et Prefix
H) ardware Configuration
Q) uit

-----
Buffer contains 0 of a maximum 357698 characters.

```

Operation of the PC SWL package is easy, thanks to its menu driven software program.

### Operation . . .

Lack of space does not allow me to go into all the intricate details that this product offers. But, let's take a brief look at each operational mode:

#### CW (Morse Code)

After the signal is tuned in using the built-in tuning scope and CW threshold adjust, the morse code reception is almost totally automatic. You can just set back and relax, and let PC SWL copy the code for you with its auto-speed tracking ability. A manual

speed adjust override is also included. For those unique "bannana-boat" morse code "swings," the Farnsworth mode can be selected.

RTTY, ASCII, and SITOR/AMTOR SELCAL and FEC

After the signal is tuned-in, again using the built-in tuning scope, you may wish to manually guess at the Baud rate and code or you may wish to let the automatic signal analysis feature of the software do the work for you! This feature analyzes the signal fre-

quency, frequency shift, center frequency, and Baud rate and type of code. Most RTTY options are supported including normal and reverse sense, unshift on space (USOS), automatic Line Feed (LF) after a Carriage Return (CR), automatic Carriage Return (CR) after a Line Feed (LF), parity and stop bits for ASCII, and character phase indication for SITOR/AMTOR. With all of these features, monitoring Baudot, ASCII, SELCAL, and FEC Mode B become a "snap" after using PC SWL only a short time.

### Other features . . .

The PC SWL program also supports a printer, so you can have "hard copy" if you so desire. Also, the software provides a wide range of buffers that enables you to save and review the received text without ever losing one character. Even a file directory feature is included!

### Summary . . .

Software Systems Consulting has a winner with their new PC SWL software package. If you have an IBM-compatible computer you can now add the fun of monitoring many of the digital communications modes. Performance is frankly quite remarkable due to the DSP techniques used by the PC SWL software.

Stay tuned, next month we will review SSC's PC HF FAX package!

Reviewed by Don Allen, N9ALK

**Over 75,000 active amateurs in over 125 countries throughout the world read and enjoy a different kind of ham magazine every month. They read CQ.**

**It's more than just a magazine. It's an institution.**

**SUBSCRIBE TODAY!**



**CQ** The Radio Amateur's Journal  
76 N. Broadway, Hicksville, NY 11801

Please send me CQ for  Life  3 Years  2 Years  1 Year

New  Renewal Start with \_\_\_\_\_ issue

Save \$12.45  1 year - 12 issues \$22.95  
 Save \$27.80  2 years - 24 issues \$43.00  
 Save \$43.20  3 years - 36 issues \$63.00

Name \_\_\_\_\_ Call \_\_\_\_\_  
 Street \_\_\_\_\_  
 City \_\_\_\_\_ State \_\_\_\_\_ Zip \_\_\_\_\_

Charge My Order To: Payment Enclosed \$ \_\_\_\_\_ My account number is: \_\_\_\_\_

MasterCard  VISA



# Radio Remembered

## Wandering Through The Pages Of History

BY ALICE BRANNIGAN

**W**hat's in a name? In these pages last April we mentioned that in the early 1930's, station WTAR (Norfolk, VA) had auxiliary facilities in neighboring Portsmouth, and that those facilities used the call letters WPOR whenever they operated. The WTAR identification was usually given as "WTAR/WPOR," but the (seemingly impossible) trick for DX'ers was to get a veri from WPOR itself. However, WPOR was rarely used by itself, nor was its callsign often heard without being tagged on to WTAR's. Moreover, WTAR appeared disinterested in providing WPOR veries.

That brought in a letter from Stuart H. Libby, Saco, ME. Stuart says that while he

isn't quite old enough to remember the WTAR/WPOR incidents of 1932, he does know that WPOR is a country music station on 1490 kHz (and 101.9 MHz) in Portland, ME. he says that he thinks the WPOR callsign has been there for years and (so far as he knows) has always been part of Portland.

Well, WPOR in Portland, ME has been there for years and probably longer than many of our readers can bear personal witness. Still, WPOR (AM) didn't commence operations until March of 1946. While that's a good 44 years ago, it's nevertheless more than a decade after the callsign was assigned to the WTAR subsidiary facilities in Portsmouth, VA.

Readers should keep in mind that broadcast station callsigns are continually recycled from one station to another, often with almost no gaps in time between assignments. Undoubtedly there are certain callsigns today that, if one were to trace them back through history in the FCC files, would prove to having been used at one time or another (and presently) by a dozen or more different stations in the almost 70 years of the broadcasting industry's existence. Tracing one set of call letters through history from the early 1920's to the present would be a good format around which to construct a story about broadcasting. Anybody remember the movie *The Yellow Rolls Royce*,

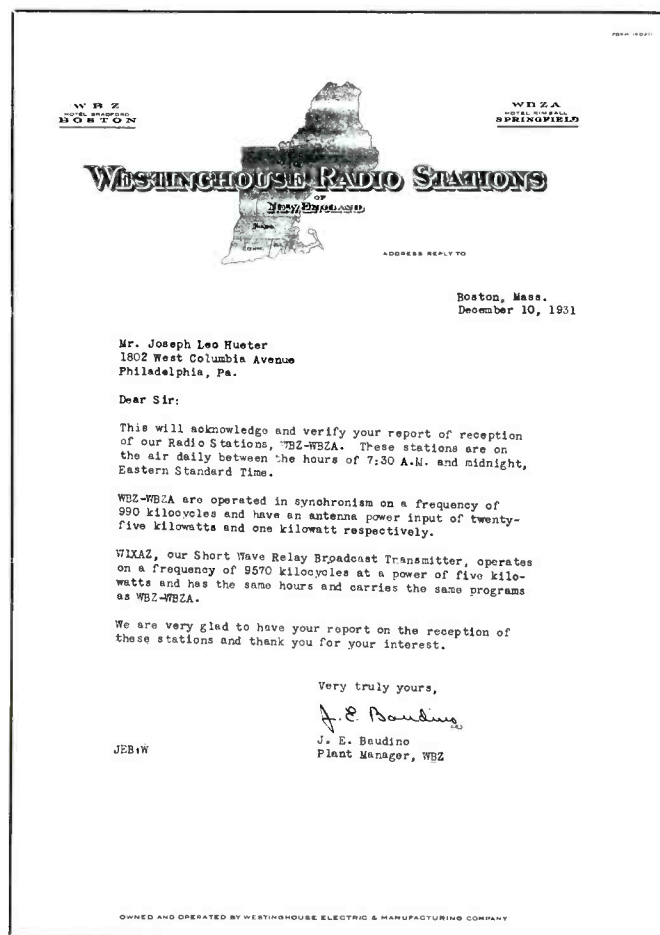
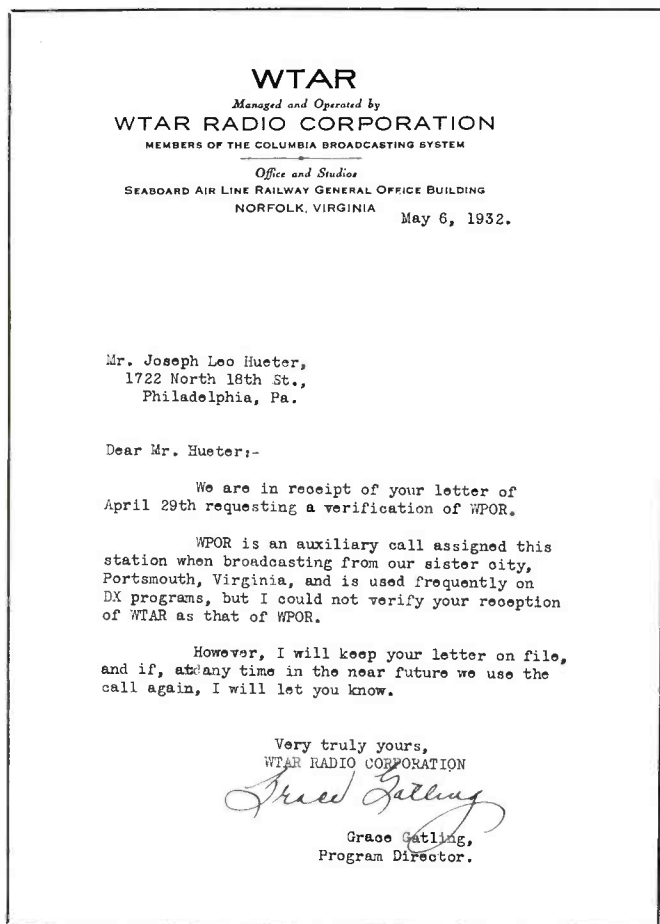

As shown here last April, in 1932, the call letters WPOR were a secondary identification assigned to WTAR in Norfolk, VA. In 1946 the call had been reassigned to another station in Maine.

This 1931 veri letter from Boston's WBZ noted the station was then announcing the dual callsign WBZ-WBZA to accommodate identifying the station's 1 kW synchronized booster in Springfield, about 140 miles west of Boston. (Courtesy Joe Hueter, Philadelphia, PA).





A 1948 QSL from WBZ makes no mention of WBZA. DX'ers who wanted a QSL from WBZA had to earn one the old-fashioned way. (Courtesy Tom Kneitel, NY).

or the earlier *Tales Of Manhattan*, which told their stories that way?

### Speaking Of Dual Callsigns

The dual WTAR/WPOR story also points out that, over the years, many broadcasters have found reasons to identify by a dual callsign. Recently, in fact, we received a letter from a reader in Worcester, MA who mentions that he used to listen to Boston's WBZ/WBZA and he always wondered why there was a second callsign given.

In the case of WBZ/WBZA, of course WBZ is one of America's first licensed broadcasters, having started in September of 1921. It is still going strong on 1030 kHz with 50 kW. For many years in the 1930's and 1940's, WBZ operated a 1 kW synchronized transmitter in Springfield, MA. Synchronized meant that it operated on WBZ's frequency, but in such a manner that the simultaneous operation of the two transmitters didn't cause any interference or heterodyne problems. WBZA was actually no more than a booster transmitter to enhance WBZ's signals in distant Springfield. WBZA had no original programming and could do no more than repeat the WBZ program-

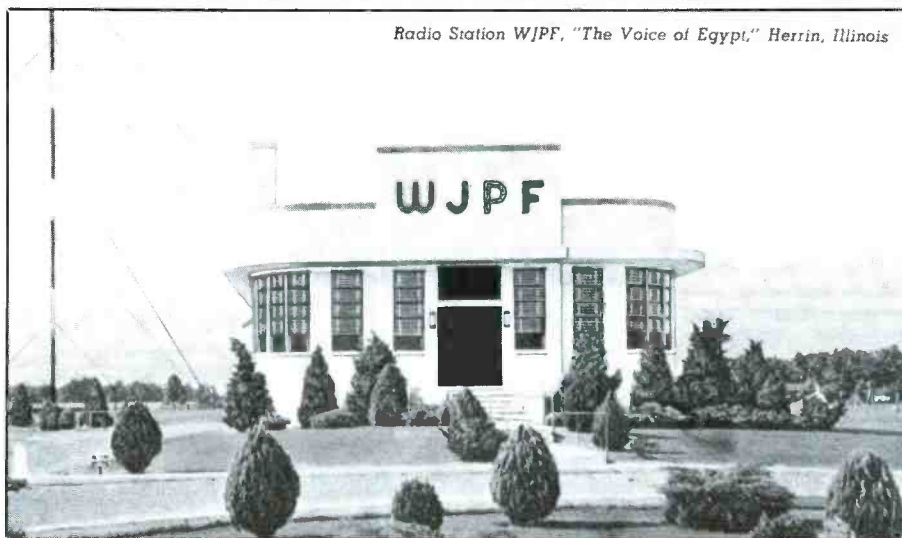

Radio Station WJPF, "The Voice of Egypt," Herrin, Illinois  
The Hotel Casino and radio station WOKO were both located on top of scenic Mount Beacon, at Matteawan (Beacon), NY in the 1920's. The station soon moved to Albany, later changed its call letters.

ming. Still, there were times when WBZ would go off the air briefly in the middle of the night for some maintenance work, and WBZA would carry the programming by itself. At such times, to the hysteria of DX'ers, only the WBZA call letters would be announced and the Westinghouse people were most generous about issuing veries to those who were able to report such golden moments. Hearing WBZA while its 50 kW big brother was dark for an hour or two was a rare DX treat, and a shot at getting a prized QSL.

Another station with a similar synchronized transmitter was WWDC (1260 kHz, 5 kW) in Washington, DC. In the 1940's, WWDC was running 250 watts on 1450 kHz, and they used a similar "100 watt

booster" to fill in a low spot in their signal coverage. The booster apparently had no life of its own (as did WBZA) so it didn't have a separate callsign.

There are still some AM stations authorized for low power synchronized boosters, all of which the FCC approves on an experimental basis.

### Phoenix Calling

Just after I wrote the line here about tracing a set of call letters through history in the FCC records, it was very strange to hear from Mary Ann Hicks of Phoenix, AZ who related a story that was very appropriate.

Miss Hicks told me that her dad had been one of the people who put up the first radio facilities for the Phoenix Police Department. That was in the early 1930's. Now the Phoenix Police are organizing a display of some of the department's history and were asking local residents to come forth with any historical items relating to the agency.

While looking for something appropriate, in the back of a closet she located an old microphone with the callsign "KGZJ" in large letters across the top. Only problem was there didn't seem to be anybody connected in the Phoenix Police who could trace the agency's callsign back past KOA789, assigned in the late 1940's. Even though she thought that this microphone might have been the original Phoenix PD dispatching mike, the agency required some confirmation prior to its use in a display.

At that point, Miss Hicks called an FCC facility and asked if they could trace the callsign. They thought it would take about four months to dig up this information, which was far too long for her needs in providing the display item. The FCC staffer then suggested that Miss Hicks contact us as an alternative source of such data. Happily, we

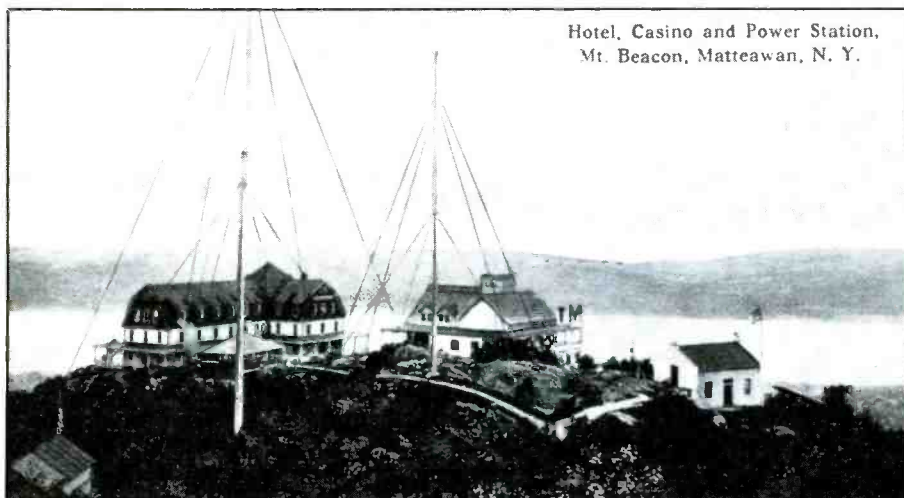

Hotel, Casino and Power Station, Mt. Beacon, Matteawan, N. Y.  
WJPF's stunning studios when the station first went on the air 50 years ago this month. This original building eventually required such extensive repairs that it seemed easier to raze it than fix it. A new structure (an exact duplicate of the original) was built on the same spot and is still in use.



The WJPF studios were small town, mini-version of the type of architecture being used by the network headquarters in Hollywood, rounded corners and all. Compare it with the NBC studios at the bottom of this view.

were able to confirm KGZJ as the original Phoenix Police call, running 100 watts on 2430 kHz. It took us about five minutes to find this, and the next day we mailed off photocopies of the required confirmation material.

Happy to provide this type of service whenever we can.

### Speakin' Beacon

A popular site for locating all manner of communications antennas in the Mid-Hudson Valley area of NY has long been 1,600 ft. Mount Beacon, at Beacon, NY. Maybe, compared to the Rockies or the Sierra Nevadas it's just a bump on the landscape, but in the Beacon area it's a prominent landmark that rises above everything else.

Seems as though Mount Beacon goes way back as a good site for antennas, as seen in an old (but undated) picture postcard we were sent not long ago. The card shows the *Hotel Casino and Power Station* on top of Mount Beacon. Two large, heavily guyed radio masts are shown next to the mountaintop hotel. Undoubtedly, the panoramic view of the Hudson River was a ma-

ajor feature of this hotel, along with the cool summer breezes on top of the mountain.

The radio towers belonged to station WOKO, which began operating on June 14th, 1924 on 1390 kHz with 500 watts. This station was operated by the Hudson Valley Broadcasting Company, 800 South St., in Beacon. In November of 1929, the station changed frequency to 1440 kHz.

In 1931, WOKO came down off the mountain and relocated to Albany, NY, where it was operated on 1430 kHz by WOKO, Inc. In the early 1940's, WOKO shifted over to 1460 kHz, where it upped its power to 1 kW (500 watts at night). Despite the Albany location and changed corporate name, the station was still run by its original owner, Harold E. Smith.

This station is presently known as WGNA on 1460 kHz, where it runs 5 kW's of country music from the Albany suburb of Rensselaer. The present owners acquired the station two years ago.

### Silent Station

For those who mourned the passage of coastal telegraph stations WPA, WOE,



David Ivarson's resurrected 2-tube regen receiver. The Bud plug-in coils are still in their original 1940's box.

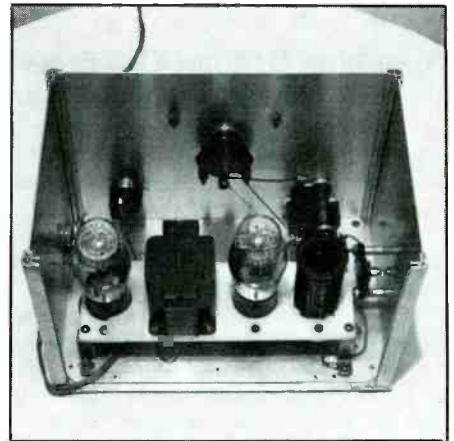

The 2-tube regen covers 1600 kHz to 12 MHz with its two Type 30 tubes. The plate supply is 45 V, with 3 V on the heaters.

WMH, WSL and KOK, it wasn't good news to hear that Western Union filed with the FCC to shut down coastal station KFS. Always sad to see one of these old timers fade; KFS began operation in spark days from San Francisco.

On a more pleasant note, old time broadcaster WGBB, Freeport, NY (1240 kHz) was purchased about two years ago by WBAB-FM of Babylon, NY. The WGBB staff was let go and the station turned into WBAB-AM, repeating WBAB-FM's rock music format. Many residents of Freeport protested this fate of what had been a rather historic (1924) station started by a local ham operator. WGBB was still running only 100 watts into the 1940's when all other 100 watt stations went to 250 watts or more.

A purchase will soon restore the WGBB call sign to this wonderful station. Incidentally, WBAB-FM's original AM affiliate (WBAB-AM) was on 1440 kHz, but a number of years ago was sold to new owners and became WNYG, a great oldies station.

In a similar vein, in 1948, Newark, NJ station WVNJ went on the air with an easy-listening music format on 620 kHz. After about forty years, WVNJ became Spanish language WSKQ, much to the unhappiness



A bumper sticker from hometown station WRIN in Indiana.

WCAU PHILADELPHIA, PA. W3XAU

RECEPTION VERIFIED

We wish to acknowledge your communication in reference to Broadcasting and also take the opportunity of thanking you.

Assuring you of our appreciation and hoping to receive your further co-operation, we remain,

Sincerely yours,

UNIVERSAL BROADCASTING CO.

A rather vaguely-worded QSL sent out by WCAU in 1931 also lists the callsign W3XAU, which was a shortwave relay. The words "Reception Verified" were added by the station on a typewriter. (Courtesy Bill Mahoney, WV).

of loyal WVNJ listeners. Now, the WVNJ callsign is being resurrected by a new station on 1160 kHz (10 kW/2.5 kW) in Oakland, NJ, which is not too far from Newark. The new WVNJ (due on the air this month) will be running the *Kool Gold* oldies music format. Nostalgia rules!

### Art Deco Studios

There's nothing quite as picturesque as one of those neat little hometown radio stations built in the late 1930's or early 1940's. The style of these stations captures AM broadcasting during an era that was very special and exciting time in its evolution. Maybe these stations never achieved the media attention given to stations like WLW, WLS, WEA, KDKA, or KFI, but that didn't mean that they were any less worthy of recognition as being vital contributors to broadcasting. We always enjoy spotlighting these stations.

Case in point, WJPF of Herrin, IL. The WJPF signal first hit the airwaves on August 28th, 1940 with 250 watts on 1310 kHz, the creation of Orville W. Lyeria. Known as *The*

*Voice of Egypt*, the building designed for WJPF was a stunning single story white stucco edifice with rounded corners, green trim, and the callsign in large letters out front. A single tower was erected to the rear of the building. This was beautiful; a small-town, mini-version of the "moderne" studios being built in larger cities by the networks.

In a major national frequency shuffle that took place not long after WJPF went on the air, the FCC shifted the station over to 1340 kHz. WJPF is still on 1340 kHz, only now it runs 1 kW and since May of 1988 it's had new owners. WJPF runs the *Music Of Your Life* format which means that many in the WJPF audience have probably been loyal listeners right from the day Orville Lyeria put up that original building and turned on his radio station, 50 years ago this month! Happy half-century, WJPF; here's to another 50!

### Another Hometown Radio Fan

A letter from Kyle D. Conrad, Brook, IL notes that he is 21 years old and has been a broadcaster for a quarter of those years. Kyle works at WRIN, a 1 kW daytime on 1560 kHz which also operates FM'er WLQI on 97.7 MHz. Both stations are in Rensselaer, IN. The AM outlet has been in operation since September of 1963, and Kyle says that it's a real treat to be part of a local, small town radio where they can run call-in trading-post programs, announce lost pets, and let local area residents announce community events and also air out their viewpoints.

Kyle also like checking the station out for relics of its past. Thusfar he has located an old console board as well as the dusty AP press teletype machine, both long out of service.



Didja hear the one about the farmer who hooked his aerial wire up to the water pump windmill? Well, you had to be there to fully appreciate how funny it was.

## MFJ SHORTWAVE ACCESSORIES REMOTE ACTIVE ANTENNA

**MFJ-1024** Receive strong clear signals from all over-the-world with this 54 inch active antenna that rivals long wires hundreds of feet long.

"World Radio TV Handbook" rates the MFJ-1024 as "a first rate easy-to-operate active antenna ... Quiet with excellent dynamic range and good gain ... Very low noise factor ... Broad frequency coverage ... the MFJ-1024 is an excellent choice in an active antenna."

Remote unit mounts outdoors away from electrical noise for maximum signal and minimum noise pickup. Mount it anywhere - atop houses, apartments, ships, buildings, balconies.

Covers 50 KHz to 30 MHz. High dynamic range eliminates intermodulation. Control unit has 20 dB attenuator, gain control. Lets you switch 2 receivers and auxiliary or active antenna. 'On' LED. 6x2x5 inches. Remote has 50 ft. coax and connector. 3x2x4 in. 12 VDC or 110 VAC with MFJ-1312, \$12.95



## INDOOR ACTIVE ANTENNA

**MFJ-1020A** Now you'll rival or exceed the reception of outside long wires with this tuned indoor active antenna. "World Radio TV Handbook" says MFJ-1020 is a "fine value ... fair price ... best offering to date ... performs very well indeed."

Its unique tuned circuitry minimizes intermod, improves selectivity, reduces noise outside tuned band. Functions as a preselector with external antenna. 0.3-30 MHz. Telescoping antenna. Controls are Tune, Band, Gain, On-Off/Bypass. 6x2x6 in. Use 9 Volt battery 9-18 VDC or 110 VAC with MFJ-1312, \$12.95



## ANTENNA TUNER/PREAMP



**MFJ-959B** Don't miss rare DX because of signal power loss between your antenna and receiver. \$89.95

The MFJ-959B provides proper impedance matching so you transfer maximum signal from your antenna to your receiver from 1.6 to 30 MHz. You'll be surprised by significant increases in signal strength.

20 dB preamp with gain control boosts weak stations. 20 dB attenuator prevents overload. Select from 2 antennas, 2 receivers. 9x2x6 inches. Use 9-18 VDC or 110 VAC with optional AC adapter, MFJ-1312, \$12.95

For your nearest dealer or to order:

**800-647-1800**

Order from MFJ and try it. If not satisfied return within 30 days for refund (less s/h). Add \$5.00 s/h. One year unconditional guarantee. Free catalog.

**MFJ ENTERPRISES, INC.**

Box 494, Miss. State, MS 39762  
601-323-5869 Telex: 53-4590 MFJSTKV

**MFJ . . . making quality affordable**

## More Dusty Radios

An anonymous reader in Pomona, CA sent in a printed card telling of *Ye Old Electric Store*, which deals in antique radios and old radio books, Tesla Coils, vacuum tubes, meters, and related materials. This is at two locations, Browning Antiques, 504 West 6th Street, Beaumont, CA 92223; also the General Store, 2650 Alessandro, Riverside, CA 92508. Check it out.

David Ivarson, W3WBE, of Collegeville, PA wrote to the magazine to tell us about the two-tube regen receiver his dad gave him back in the 1940's. It was a receiver complete with four Bud plug-in coils and a Brandes headset. The receiver provided many well-remembered moments, but eventually was replaced by more sophisticated equipment.

In the forty years that followed, the little receiver offered up its parts for other projects, then got bounced around in three household moves. David tells us that the POP'COMM articles on old-time radio inspired him to see if the set could be restored. A search of the attic managed to round up the coils (still in the original box), also the headphones, the original Type 30 tubes, the bandspread dial and other components. The tube filaments checked out as good!

Eventually, about 70% of the original parts were rounded up, along with the original 1938 *Radio Craft Magazine* schematic. At that point, restoration was started. This wasn't without problems, since one doesn't

**VV**  
**TELEVISION**  
**SALES**  
*and*  
**SERVICE**  
**HERMOSA BEACH**



**FREE PARKING**

*TV sets used to have screens with curved sides. Actually, you were seeing most of a round CRT, with the top and the bottom portions masked off. This old TV sales/service postcard gives you a good idea and recalls the days before square CRT's.*

show up at Radio Shack and buy a 45 V "B" battery. A stack of five 9 V batteries were pressed into service. The only major design capitulation to modern technology was to install an additional antenna terminal connected to a one-turn stationary link to allow a coax-fed antenna.

The set worked immediately, opening the door to a world of memories of tuning around for CW practice, black/white striped Burgess batteries, and haywire antenna on the roof, and trips to New York City's "Radio Row" (Courtland Street) to visit places like "Cantor the Cabinet King."

David sent along some photos of his project. The major new components are in the metal chassis and cabinetwork.

Philadelphia's WCAU also began in 1922 with 250 watts under the auspices of Durham & Co. In 1924 it was on 1050 kHz and running 500 watts. The following year it was acquired by Dr. Leon Levy and Isaac D. Levy (Universal Broadcasting Co., Hotel Pennsylvania) who increased the power to 1 kW (1000 kHz, later 1170 kHz) and to 10 kW a year later. In 1932, it went to 50 kW. In 1946, it was purchased by the *Philadelphia Record*, but the following year it was sold again to the *Philadelphia Bulletin*. CBS purchased WCAU in 1958. Presently it's on 1210 kHz. Isaac and Dr. Leon Levy were key figures along with William S. Paley in the formation of CBS in 1927, and WCAU was the first affiliate signed.

### A Question

Elton Byington, Operations Manager, of Associated Press in New York City writes to note that, before NBC brought them, WEFW (later WNBC, now WFAN) in New York City, and WCAP (now WWRC) in Philadelphia were owned by AT&T. He also points out that Washington's Bell operating company is (and was) the Chesapeake and Potomac Telephone Co., hence the callsign WCAP. This is the same telco that serves Baltimore and once served Philadelphia.

Elton's question is whether AT&T once owned WCAO and WCAU. Back in the early days (1924), WCAO (Baltimore, 833 kHz, 50 watts) was owned by Sanders and Stayman Co. By 1928, it was licensed to Monumental Radio Co., Inc., and running 250 watts on 1230 kHz, later 600 kHz. Although having started in May of 1922 makes WCAO the oldest broadcaster in Maryland, it was never owned by AT&T. Monumental's Robert V.O. Swarthout ran the station until 1956 when it was purchased by Plough Broadcasting, Inc.

### Service, Please!

Two interesting cards you might enjoy came our way. One is from a cartoon radio card from a radio shop in Yankton, SD and seems to be from the late 1920's or early 1930's. The other card is fancy and was sent out by a TV shop in Hermosa Beach, CA. We guess it had to be from about 1960.

The cartoon card has some fun with farmers using windmill towers as supports for antenna wires, resulting in reception of only long-winded political speeches. The card from the TV shop, which is in full color (a way of providing a subtle hint that new color TV sets were in stock), provides a reminder of the unusual shape of the screen of TV sets in those days.

### Putting On The Ribbons

That's a wrap for August. Lots of stuff in the basket here, but no more room allocated for my rambles for this go-round. Thanks to all for the help and cooperation, the old QSL's, old photos, old station rosters, all the inquiries, ideas, and kind words. Like they say in the song, see you in September!

**SE** SIGNAL ENGINEERING'S  
 High Performance CB Antennas

**SUPERHAWK**  
 \$114.95



**Goldenrod**  
 45 Mobile  
 Antenna

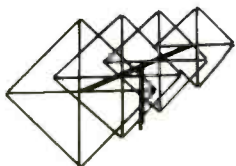

**WHITE LIGHTNING**  
 \$199.95

**SPYDER A**  
 \$35.95



**LIGHTNING 6**  
 \$359.95

**THE most POWERFUL**  
 CB base in the world today!

All SE PATENTED rotary beams are true quads and OUTPERFORM their counter parts (quadyagi types). SE's patented SFS matching system makes SE QUADS the most technologically advanced antennas in the world today.  
 If your dealer doesn't have SIGNAL ENGINEERING, write or call for full specs. DEALER inquiries invited.

**SIGNAL ENGINEERING**

2624 Fayette Drive, Mountain View, CA 94040  
 (415) 948-3833

# Those Strange Signals Above The FM Band?

## Ten MHz Of New VHF Signals 108-118

BY RALPH C. CRAIG

In the VHF radio spectrum, there is a band of frequencies 10 MHz wide, not often utilized by scanner owners. These frequencies have provided me with hours of interesting listening, useful information, and sometimes moments of great drama. In the past this band was not always available to the scanner enthusiast, but now it is becoming more and more available. Many manufacturers make scanners covering this band, some make several models. This article tells how I searched, identified, located and visited a station in this once "forbidden band."

### The Search

It was with great expectancy that the frequency limits were entered into the scanner and the search mode activated. The new "all-frequency" low VHF through microwave, 1000 MHz, multi-mode, 300 channel "Super" scanner had already given me hours of pleasure. However, my favorite frequencies stored in its memory occupied but a few channels in its vast memory bank. To fill the remaining memory a systematic search had been initiated to locate, identify, log and enter into memory new frequencies of interest.

The low VHF band had been completed, the low VHF television and commercial FM band bypassed. The next band of the spectrum to be considered was that band extending from the end of the FM band, 107.9 to the beginning of the AM aviation band at 118.0 MHz. The frequency chart indicated that this was "U.S. Governments" territory. All my past issues of POP'COMM had been retrieved and reviewed. Nothing had been found, not even a hint as to what occupied these frequencies. What could be found there? Were there "secret" law enforcement stations? Was this a new satellite band? Were there "spy" stations there? None of my old scanners had had this band, was it another "forbidden band? What lurked in this special band? What I found will be of interest to all scanner users.

### Odd New Signals

With the search mode activated, the bright numbers on the scanner's display rap-

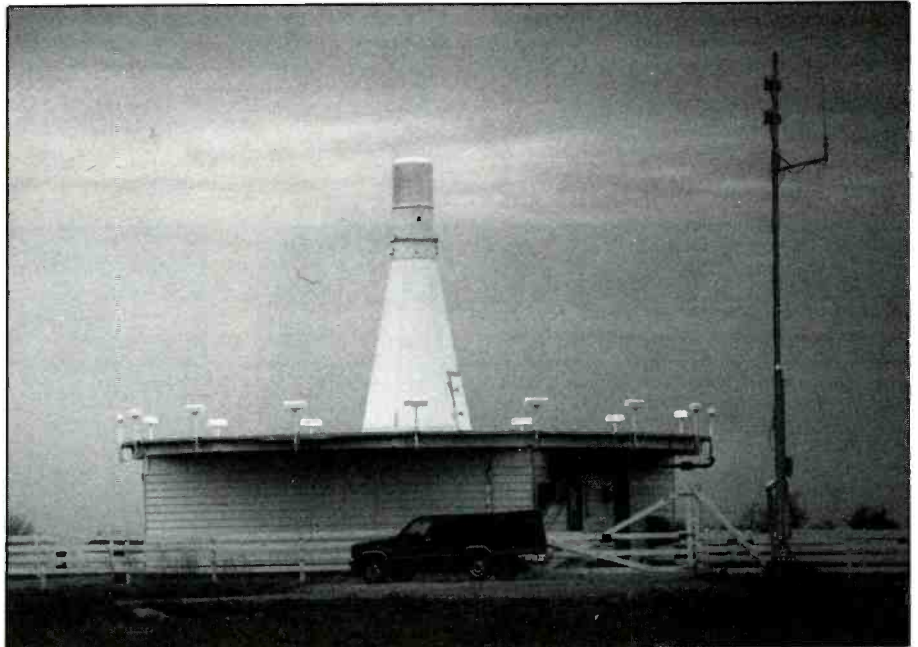

*VORTAC. The antennas for the VOR are housed in the "upside-down ice cream cone" antenna shelter. The large round roof is a metal counterpoise that supplies a known reflecting surface for the radio waves. The white "birdhouses" around the edge of the counterpoise are detectors used to check the accuracy of the radiated VOR signals constantly. The pole to the right of the building supports the LRCO antenna, and the monitor antennas for the TACAN.*

idly spooled down-frequency. Eternity seemed to pass before the flickering display suddenly stopped, the scanner locked on to a signal, and the squelch opened. The display indicated 115.5 MHz. There was a signal there but it was weak, almost down in the noise. Listening carefully, I could distinguish a strange "hum," a high pitched "whistle" that varied rhythmically, and "someone sending" code.

The code seemed odd, an audio tone keyed with what appeared to be the same three letters, intermittently broken with silent periods. The scanner stayed on the channel for a long time, nothing else could be heard. Hesitant, fearful that I had not listened long enough and would miss a "call," yet anxious to know what else might be on the band, the search mode was reactivated. A short wait and again the scanner

locked on to a signal, 113.8 MHz. A loud signal burst from the speaker, the same loud "hum" like a transmitter with a poorly filtered power supply, the same high pitched "whistle," the same code-only sounding different. What were these signals? Where did they originate? What was their purpose? Who was sending them?

Suddenly, a voice overrode the cacophony of the strange sounds, and gave a brief "cryptic" transmission. Lost in thought pondering what these signals were, I missed understanding what was said. Patiently I waited, hoping for another transmission. My hopes were not in vain for presently the voice returned, "This is Tipp Radio, time 0215, aviation weather." Then followed the weather conditions at several cities. Even though it was late, the listening continued, I had to find out what these stations were.

Nothing happened until a 1/2 hour later. A female voice came on, the same preamble, another list of weather at several cities. Eyes heavy with sleep, I finally "pulled the switch" and retired.

## Discovery

The next morning one of those serendipitous happenings occurred that so often changes one's life. Stopping at the usual coffee shop for breakfast, I found the booths all taken. Flopping onto the only open seat at the counter, I gave my order and opened my new issue of POP'COMM. A well-groomed gentleman on the next stool spoke. "You like POP'COMM? I read it every month myself." During our conversation, the strange signals that I had "discovered" were mentioned. "I'm a pilot," he replied, "those aren't unusual or strange signals. They are used every day by hundreds of flyers." Having finished, he rose, handed me a hastily scribbled list of books, "These will

help you in your search," he said and departed. What was discovered with his help was a whole series of radio stations, that extend nearly worldwide, that can supply interesting, useful and exciting listening to the scanner user.

## VOR/VORTAC's

Scattered throughout the U.S and wherever it's sphere of influence extends, are approximately 1000 radio facilities, operating in the spectrum 108.0 through 117.9 MHz, which provide essential radio communications and guidance to pilots. These stations known as VORs (Very high frequency Omni Range) operate on channels spaced 100 kHz apart (there is a plan for future expansion using 50 kHz). When co-located with another navigation facility called TACAN (TACTical Air Navigation) operating in the microwave (1000 MHz) range used by the military, they are known

as VORTACs. One is shown in figure 1. The April 1989 issue of POP'COMM, in the "Communications Confidential" column carries a similar picture with the question, "What is the function of this unusual Station?" While all of the VORs provide navigational signals, about 70% provide a communication channel between the pilot and the FSS (Flight Service Station) that controls the VOR. It is the latter that is of interest to scanner enthusiasts.

## How It Works

The main purpose of the VOR is to provide "highways in the sky" for pilots to follow as they fly between cities. Through use of radio waves, they radiate signals that when received by special radios in the aircraft lets the pilot select any number of courses to fly 360 degrees around the station hence name "OMNI". Secondary is the communications function.

When first listening to a VOR most people

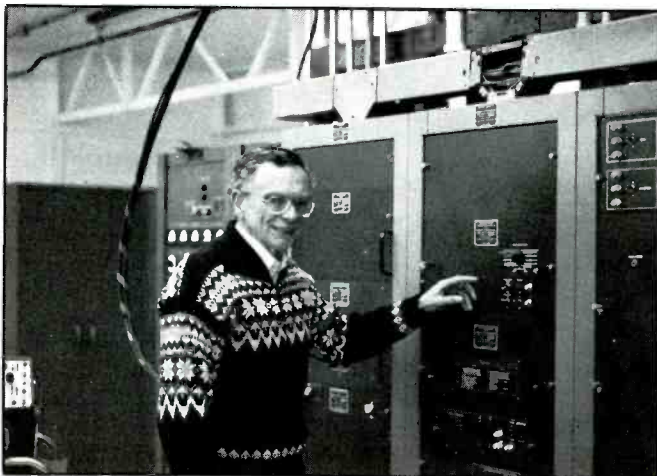

The author inspects the VOR equipment on a visit to a VORTAC.

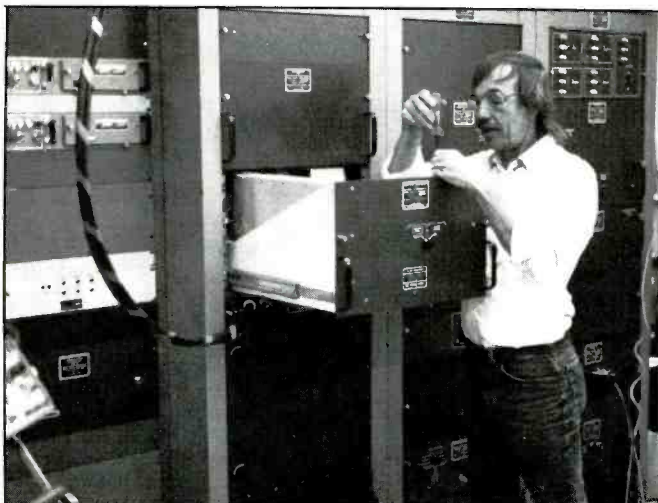

FAA (Federal Aviation Administration) Technician, Bob Hemminger, adjusts the equipment after minor repairs. The entire station is microprocessor controlled. The two LRCO receivers are in the top of the left rack.

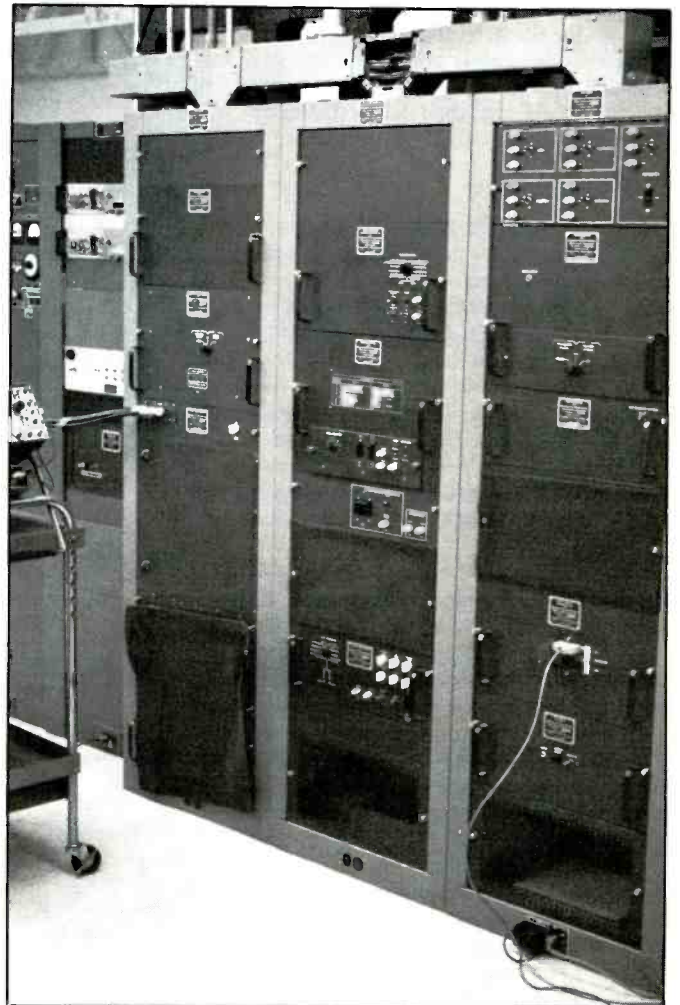

VOR equipment racks. The right rack contains the VOR equipment, a 120 watt transmitter, the goniometer which develops the 30 Hz space modulation signals, Facility Central Microprocessor, and two monitors used to check the accuracy of the station at all times. The middle rack contains power supply and control equipment. The left rack contains the TACAN equipment.

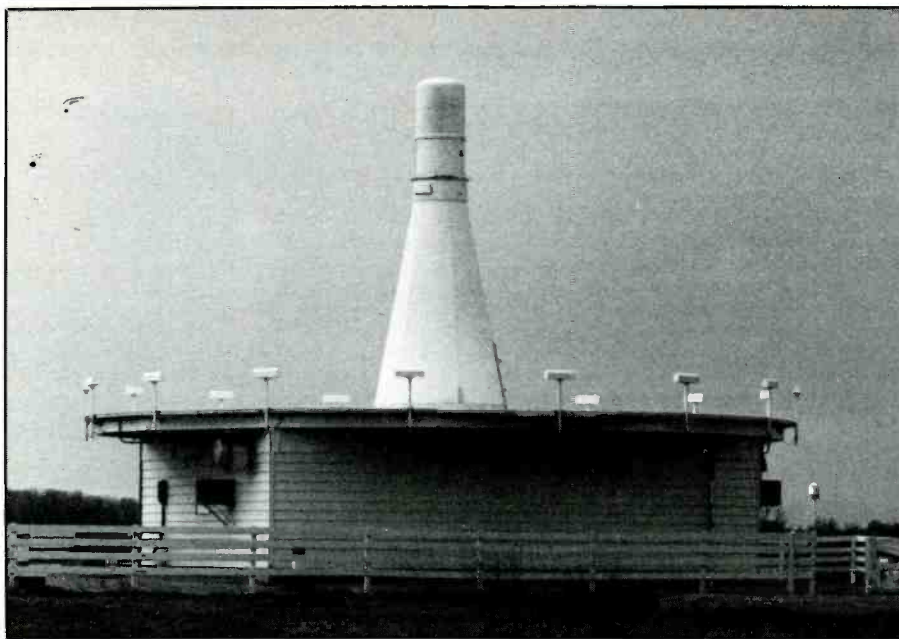

Closeup of VORTAC building. The VOR antennas are in the sloping area. The object on top of the antenna shelter is the TACAN antenna. Eighteen "birdhouses", or detectors are mounted on the edge of the metal counterpoise roof, they check the accuracy of the VOR constantly.

are surprised by the high "hum" level. It sounds just like a transmitter that has lost a capacitor in its power supply. Actually, this "hum" is an essential part of the navigational signal. All of you know about the various types of modulation: CW, AM, FM, SSB. Some of you may know about the new ACSSB (Amplitude Companded Single Side Band) modulation that is making inroads in the VHF (the new 220 MHz is expected to use ACSSB); but how many of you have heard about SPACE MODULATION?

In the August 1988 issue of POP'COMM, Havana Moon in his article "Spy Numbers Anomalies" suggests the possibility of such a system of modulation. Little did he realize that such a system not only exists, but is vital to the operation of the VOR. Space Modulation occurs when the side bands which carry information and the carrier are radiated from separate antennas. In SSB, the side band is radiated by the transmitter, the receiver supplies the carrier via a BFO. In Space Modulation, the side bands and the carrier originate from separate sources outside the receiver.

In the VOR, side band energy, necessary to provide a 30 Hz signal that varies in phase around the station, is radiated from two pairs of closely spaced antennas. The carrier is effectively radiated from a separate antenna. When the carrier and the side bands are received by your radio, (and the radio in the aircraft) they are converted into a 30 Hz AM signal. This is the high "hum" level that you hear. A second signal, modulating only the carrier is a 10 kHz (actually 9960 Hz) signal that is frequency modulated by 30 Hz. This is the high pitched "whistle" that varies in

pitch. In the aircraft, a special receiver detects the two signals, compares their phase, presenting to the pilot a course to fly. A third signal on the carrier is a 1020 Hz audio tone keyed in Morse code with the three letter identification code for the VOR station. This is the constant keyed code you hear. While all VORs have these navigation signals, about 70% of them also have a communication feature. The carrier is also AM modulated with voice of the Specialist at the FSS. It is these communications that occur between the pilot and FSS that is of interest to scanner users.

### Communications With The Pilot

At all VOR's equipped with voice channel capability is located a LRCO (Limited Remote Communications Outlet), a receiver tuned to 122.1 MHz. The pilot initiates communications by calling the VOR on this frequency. The FSS replies using the voice channel of the VOR to which the pilot's radio is tuned. Unfortunately for the scanner user this precludes him from hearing both sides of the conversation, unless he has a second scanner tuned to 122.1 MHz. At fifteen minutes, and forty-five minutes past each hour broadcasts are made over the VOR giving the weather conditions at selected airports, also included are any warnings of significant weather conditions. In addition, a few VOR's are equipped with ATIS (Automated Terminal Information System) or TWEB (Transcribed WEather Broadcast). Both systems continually give infor-

mation about the weather and landing conditions at airports. ATIS for a selected nearby airport, TWEB for several locations. These features operate 24 hours/day via tape recordings that are updated at least hourly.

### What Can I Hear?

This is fine, but what can the scanner enthusiast expect to hear and enjoy on these stations? The one-half hourly weather broadcasts are especially interesting in foul weather. It will keep you informed of rapid changes, often before the TV does. SIG-METS, (SIGnificant METeoro logical information) lets one know of developing severe weather conditions. TWEB or ATIS is a 24 hour weather information supplier. Pilots use the VOR voice channels for filing flight plans, changing their flight plans, closing their flight plans, reporting weather aloft, obtaining weather information for special locations and requests for assistance. These latter contacts can be times of real drama. Overheard have been calls by lost pilots on their first solo cross-country flights becoming disoriented.

The FSS Specialist locating him/her by reference to ground features, then directing them to a safe landing. A pilot caught unexpectedly above rapidly developing cloud cover requesting and getting guidance to a "hole" in the cover and a safe descent. A pilot requesting and receiving a DF (Direction Finder) steer to help him/her determine his/her location.

### Where Are They Located?

Although the VOR/VORTACs tend to be concentrated on the periphery of large cities, they are found throughout the countryside. They are spaced about 200 miles apart along airways all across this country and abroad (in certain areas). Being an air navigational facility, their radiation pattern is directed upwards, therefore, ground reception is usually limited to 10-15 miles.

Many of you have seen these facilities as they tend to be located adjacent to highways. Appearing like displaced "Dairy Queens" they are easily spotted. The small white square building is topped with a large flat, round roof, on which is mounted an "upside down ice cream cone" antenna shelter. The sloping area contains the VOR antenna. The pole to the side supports the LRCO antenna, and the monitor antenna used to constantly check the accuracy of the station.

In preparation for this article, I visited the FSS at a nearby airport. The FAA people were very friendly, carefully explaining the VORs and the services they provide. Even a visit to a VORTAC with a FAA maintenance technician was arranged. The next time you sit down to a monitoring session, give the frequency band 108 through 118 MHz a try. Chances are you will find some useful, interesting and even exciting communications.

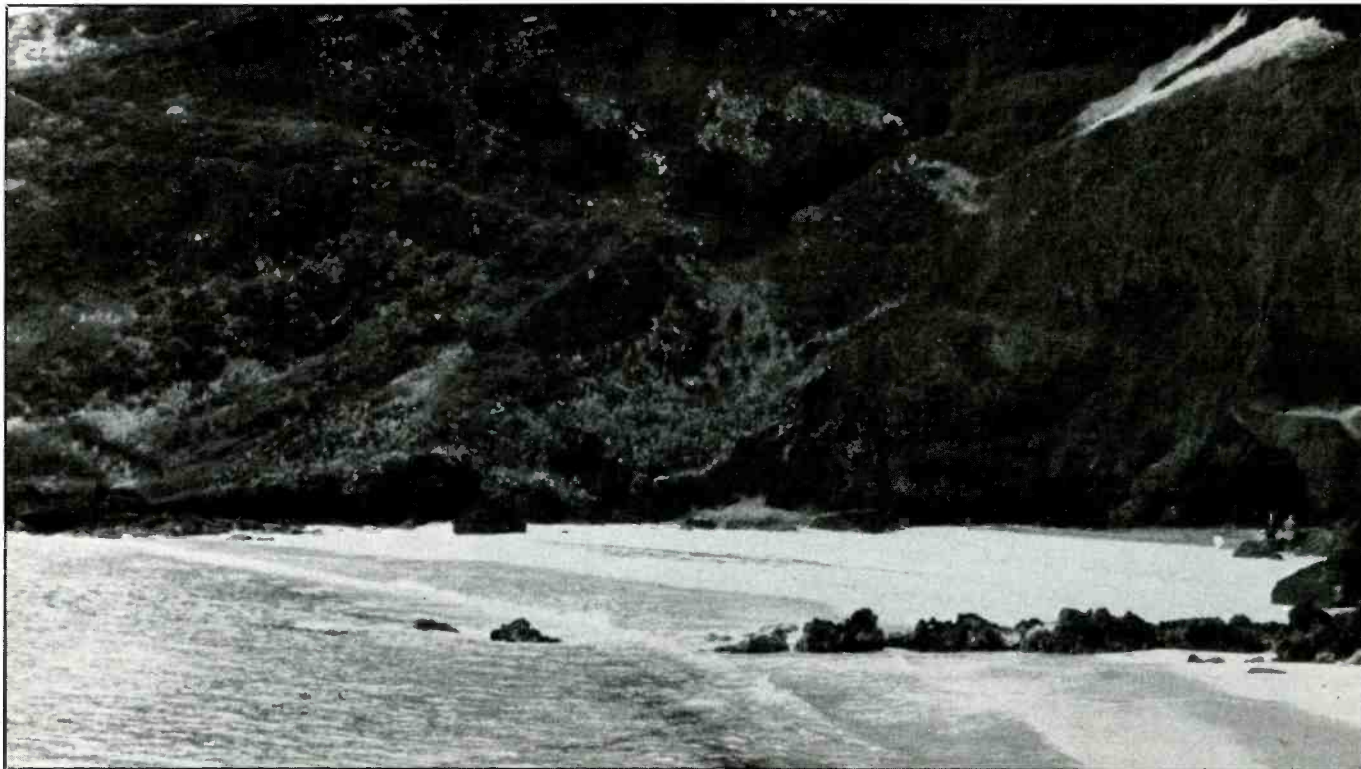

The coast line of Easter Island, off the coast of Chile, is dotted with white sand beaches. During their off-duty time, Hammer Ace team members took the opportunity to visit several of them. (U.S. Air Force photo by SSgt. Michael Riley).

# DX'ing Space From Easter Island

## *The USAF Sets Up A Monitoring Post*

BY SSGT. JOSEPH R. LLOYD, Air Force Communications Command

**R**eports from Easter Island, off the coast of Chile, indicate a sudden, but short lived, surge in population directly related to Air Force communications with Atlantis.

A two-person Hammer Ace team from Scott AFB provided all communications for the 48 crewmembers of two Advanced Range Instrumentation Aircraft from the 4950th Test Wing, Wright-Patterson AFB, Ohio. The aircraft were on Easter Island to provide telemetry checks of a Department of Defense satellite released by the space shuttle Atlantis during its recent space voyage.

At first we were to provide a one-time communications link for the ARIA crews aboard the aircraft to establish the proper reception frequencies for their on-board communications equipment," SSgt. Michael Riley, one member of the Air Force Communications Command's special communications team, said. "But, once on Easter Island, we found the only off-island commu-

nications to be a single phone line to Chile that closed down around 8 p.m. We became the only available communications on the island for the crew."

Hammer Ace was the ARIA ground communications link between Easter Island and the states as well as the emergency back-up if on-board communications failed on the ARIA aircraft. Between Feb. 20 and March 8, the team processed more than 200 morale calls for the ARIA ground crews.

"The operation was intended to be fairly quick, but, slippage of the take-off date for the Atlantis meant the crews were on the island longer than expected," Sergeant Riley said. "Many of the crew used us to handle unexpected problems back home due to the delay in launching the shuttle."

Once the space shuttle launched and deployed the satellite, the ARIA crews collected data from the satellite to make sure it was in the proper orbit.

"Besides the morale calls, we provided all

ground communications for the operation," Sergeant Riley said. "We operated our equipment from our hotel room. While the ARIA crew commander was making a report one day, the hotel and surrounding area lost power. While TSgt. Richard L. McAfee, the team chief readied the equipment, I contacted the hotel manager and got permission to remove the battery from the hotel tour bus. In less than 15 minutes we were back on the air using the battery for power. The commander got his message through and was very impressed."

Sergeant Riley later discovered that the whole island operates from generators left behind by the Americans during World War II and power problems were not uncommon.

The ARIA crews were able to complete their mission of ensuring the success of the Atlantis mission because a two-man Hammer Ace team from AFCC was able to provide all of the communications needed during their almost 17 day stay on Easter Island.





SSgt. Michael Riley erects a satellite antenna on the grounds of the hotel the Hammer Ace occupied during their stay on Easter Island. The team was on the island in support of two Advance Range Instrument Aircraft. (U.S. Air Force photo by TSgt. Richard L. McAfee).



A row of the famous Easter Island statues created by mysterious residents of the island. Hammer Ace is often called to such exotic locales for emergency support of critical Air Force missions. (U.S. Air Force photo by SSgt. Michael Riley).

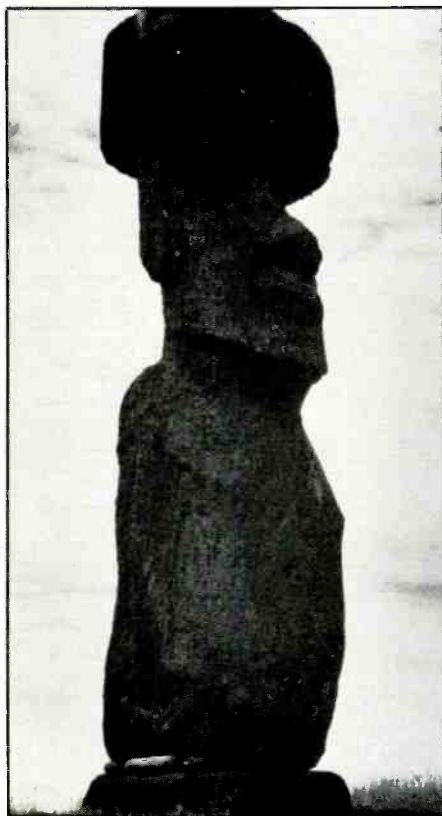

A close-up of one of the many, large stone statues that dot Easter Island. (U.S. Air Force photo by SSgt. Michael Riley).



One of the 4950th Test Wing's ARIA aircraft sitting on the runway at Easter Island. This C-18 and an EC-135, both from the 4950th TW, Wright-Patterson AFB, Ohio, were used by ARIA to provide telemetry checks of a DOD satellite released by the space shuttle Atlantis. (U.S. Air Force by SSgt. Michael Riley).

PC

# COMMUNICATIONS CONFIDENTIAL

## YOUR GUIDE TO SHORTWAVE "UTILITY" STATIONS

According to an article in the March 1990 SEA Power, the US Navy will deploy in 1992, three relocatable over-the-horizon radar (ROTHR) systems. Thus, the US Air Force systems will have some company along with the Russian Woodpecker (OTHR).

The prime contractor for the US Navy system is the Equipment Division of Raytheon Company. The system is a phased array "backscatter" radar that reflects an HF signal off the ionosphere for detection of airborne and surface targets. The system operates within 5 to 28 MHz and can provide coverage of ocean sectors between 500-1600 miles. A transportable shelter (8' x 8' x 20') will contain ROTHR equipment and the unit can be moved by ship, truck or aircraft to a location where the antennas and foundations have already been installed. While the primary application of the ROTHR systems is military, another valuable use is in the surveillance of air corridors frequently used by drug smugglers. During operational testing at a Virginia location, five suspicious aircraft were detected and one of them forced down near Bimini by the US Coast Guard was found to be transporting drugs.

Several readers expressed interest in additional details regarding the Chirpsounder transmissions mentioned in the March 1990 column. One such system is manufactured by BR Communications of Sunnyvale, CA. The title for the system is AN/TRQ-35 (V) Tactical Frequency Management System and it consists of three units—a spectrum monitor, Chirpsounder transmitter and a Chirpsounder receiver. The equipment provides continuous measuring and displaying of the best frequency for communications as conditions change. For a more comprehensive description of the technical specifications of the system see JANE'S Military Communications 1979-80.

Daniel Yemiola, NC wrote "Some of the numbers broadcasts in the 4 MHz band are part of the training exercises for Army Airborne Ranger units." Last November, Daniel, a Deputy Sheriff in Davidson County, NC, and a state Wildlife Officer, were investigating a small fire in the Uwharrie National Forest area. They discovered it was the campfire of a Army Airborne Ranger unit on a training exercise. While they were talking to the squad, the radioman was busy copying CW. "When I talked to the radio operator he told me that he copied number broadcasts every day, and that the numbers usually didn't have any messages in them, they were mostly for practice to help operators get their speed up. He said the frequencies changed every day but they were all close

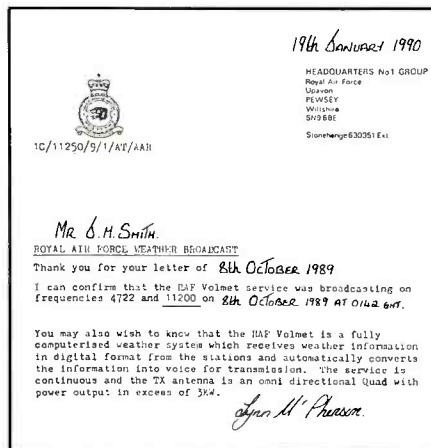

Here is a QSL from RAF VOLMET received by Jim Smith, MO. The address for this station is: Royal Air Force VOLMET, Ministry of Defense, Bracknell Meteorological Office, Met. 05b, London Road, Bracknell RG12 2SZ.

together. The frequency on that particular evening was 4046 kHz.

Daniel also offered a clarification of some locations given in the article by Chuck Robertson in the January 1990 POPCOMM. The places mentioned were in suburban Guilford County and nearby northern Randolph County, NC. The location heard as "enroute to New Jersey" was really "enroute to Jersey Church Road, which is the site of the EMS base where ambulances are repaired and refueled." The location heard as "Elisboro Road" should have been indicated as "Ellenboro Road."

In the June 1990 column, I commented on the quantity of beacons logged by Perry Crabill, VA. After several weeks of additional monitoring, Perry had expanded his total to 399 logged beacons.

Andy Gordon, CT reports the following: The USNS unit previously given as "D-Tiger" is actually USNS DeSteiguer, T-AGOR-12, an Oceanographic Research Ship. It is operated by the Military Sealift Command, under the technical control of the Chief of Naval Research. The QSL address is—USNS DeSteiguer, T-AGOR-12, FPO San Francisco, CA 96663-4012.

The USS Lexington AVT16 was heard on 2714 kHz (off freq) using the callsign "Spartan."

NAVLESCOM stands for "Naval Electronics Command." SESEF Charleston is more commonly referred to as "Charleston Test Control."

Andy was able to identify the ship carrying the van of the "Fleet Electronics Warfare Support Group" as the new Kaiser class

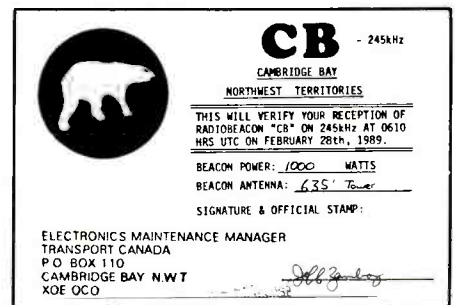

This PFC was returned to Steve McDonald, BC, Canada by Beacon station "CB."

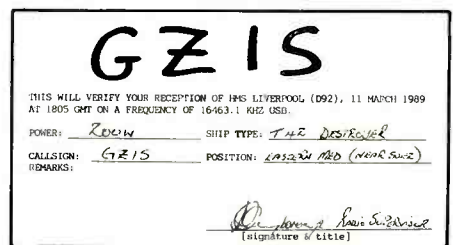

This PFC was returned to Patrick O'Connor, NH

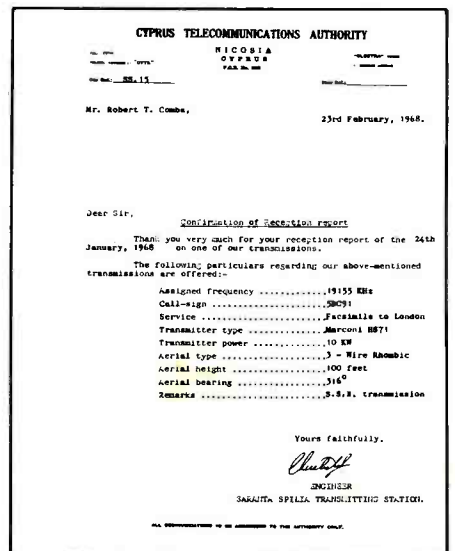

From the collection of Bob Combs, CA is this 1968 QSL.

MSC Oiler, USNS Leroy Grumman T-AO-95 The ship had not yet been assigned MARS call so the MARS call of COMFEWSG, NNNONOF, was being used.

Although many ships often use the term "Norfolk Tug Control" on 2716 kHz, the proper official term is "Norfolk Port Control."

The MARS callsign for the newly commissioned USS Normandy CG60 is NNNOCCO.

**Table 1**

|            |             |             |             |
|------------|-------------|-------------|-------------|
| 3190-3880  | 3190-4052   | 3190-4196   | 3232-4450   |
| 3213-4020  | 3384-5440   | 3880-5335   | 3880-5690   |
| 4011-5137  | 4415-5090   | 4281-5297   | 4990-5440   |
| 4455-6920  | 5440-6370   | 5330-6785   | 5150-6370   |
| 5413-7588  | 5413-6785   | 6875-7588   | 6825-7665   |
| 6875-7590  | 7660-8310   | 6785-7740   | 6850-8190   |
| 6860-8565  | 7410-10735  | 7740-9435   | 9049-10508  |
| 8120-10135 | 10243-11450 | 11560-13488 | 11445-13420 |

Note: all freqs in kHz

**Table 2**  
**Primary RAAF Channels**

| Time in UTC        | Frequencies in kHz |       |       |
|--------------------|--------------------|-------|-------|
| Day (1800-0900)#   | 8975*              | 11235 | 13205 |
| Night (0900-1800)# | 3032               | 5688  | 8975* |

Notes: \*indicates most frequent use  
#actual frequency changeover is roughly 0900 and 2300.

**Table 3**  
**Additional RAAF Frequencies (in kHz)**

|       |       |        |       |       |
|-------|-------|--------|-------|-------|
| 3032  | 3112  | 3144   | 4714  | 5684  |
| 5700  | 5718  | 5726   | 6697  | 6716  |
| 6750  | 6752  | 7658#  | 8967  | 8972  |
| 8989  | 8998  | 9018   | 9020  | 9023* |
| 9027  | 9032  | 11176  | 11209 | 11237 |
| 11255 | 11267 | 13201* | 13205 | 13244 |
| 13247 | 15062 | 15081  | 18023 | 18027 |
| 23206 | 27610 |        |       |       |

Notes: \*frequently used  
#Search & Rescue freq

Callsign TMB-3 was heard on 2716 kHz working Autec Operations with TMB-3 asking if Ops had comms with TMB-2, new callsign for Research Vessel Monob YAC61. According to Ops, Monob formerly had a "Foreclose" callsign. TMB-3 advised Autec Ops they also guarded 2820 kHz, USB. Andy indicated that after he tuned to that frequency he heard TMB-3 calling TMB-2. Another Autec Ops callsign reported was LC1647.

Simon Mason, England indicated he was currently investigating the EE/GG Broadcasts that use 3/2F identifiers and the 1-0 count to determine the paired frequencies in use. Table 1 lists those he discovered thus far.

Simon noted that the frequencies in a pair are usually within one or two MHz of each other. He also pointed out that the EE Broadcasts are being regularly jammed by warblers although not always on both frequencies of a pair.

Since the Romanian revolution, Simon has heard the Romanian "Skylark" station twice.

From Australia we heard from Chris Toms who used a Sangean ATS803A and FT747GX with a longwire of approximately 330 feet as the main antenna. As a guide to frequency selection for listening purposes, Chris pointed out that Sydney Sunrise was 1800-1900 UTC and Sunset was

**Table 4**  
**RAN Frequencies (in kHz)**

|       |       |
|-------|-------|
| 2676# | 4322  |
| 6238  | 6288  |
| 6389  | 8122  |
| 8161# | 8332  |
| 8345  | 10760 |

Notes: \*frequent use  
#Coastal Patrol use also

0800-0900 UTC. All major RAAF Bases maintain 24 hour watch on the 3 primary Day/Night bands. Ground stations usually ID as Air Force Sydney, Air Force Townsville, etc., but sometimes do utilize tactical ID's such as IRC2. The aircraft use tactical ID's like Striker 45 which would be a Lockheed P-3 Orion (Series A). Although USB is the normal mode, during the past year AM has been noted twice. The voice-security mode is a Time-Domain/Speech Inversion mix. For frequency listings of the RAAF, see tables 2 and 3.

Chris also supplied some information regarding Royal Australian Navy communications. He described the ID's used by Naval Shore Stations as being merely the location, such as Sydney, followed by the word Control. So other typical ID's would be Perth Control, Darwin Control, etc. Vessels usually use their name, thus, the HMAS Can-



TO: R.C. Watts

Confirming reception of: USCGC EAGLE (STATION)

Call letters NRLB; Frequency 6200.0 KHz on

JANUARY 27, 1990 at 0720 Z. 73's  
(DATE) (TIME)

COMMANDING OFFICER  
USCGC Barque EAGLE (WIX 327)  
FPO New York, NY 09568-3906

*[Signature]*  
SIGNATURE/TITLE



R.C. Watts, KY received this attractive QSL from the CG sailing ship "Eagle."

berra would just use Canberra normally, but vessels have been noted just using their registration number. Tactical type callsigns are used sometimes. For some RAN frequencies see Table 4.

**Abbreviations Used For Intercepts**

|     |                                    |
|-----|------------------------------------|
| AM  | Amplitude Modulation mode          |
| BC  | Broadcast                          |
| CW  | Morse Code mode                    |
| EE  | English                            |
| GG  | German                             |
| ID  | Identifier/identification          |
| LSB | Lower Sideband mode                |
| OM  | Male operator                      |
| PP  | Portuguese                         |
| SS  | Spanish                            |
| tfc | Traffic                            |
| USB | Upper Sideband mode                |
| w/  | with                               |
| wx  | Weather report/forecast            |
| YL  | Female operator                    |
| 4F  | 4-figure coded groups (i.e. 5739)  |
| 5F  | 5-figure coded groups              |
| 5L  | 5-letter coded groups (i.e. IGRXJ) |

194: Beacon TUK, Nantucket, MA at 0246. (Crabill, VA)

206: Beacon GB, Galveston-Scholes Field, TX at 0535. (Symington, OH)

212: Beacon AWW, Randolph County AP, IN at 0508

215: Beacon UIZ, Utica, MI at 0513. (Symington, OH)

236: Beacon GNI, Grand Isle, LA. TWEB in AM at 0555. (Symington, OH)

260: Beacon VXA, not identified, hrd at 0605. (Symington, OH) No ID in my refs. (Ed.)

281: Beacon RSZ, Tempe, AZ at 0959. (Humes, AZ)

- 311:** Beacon TBG, Panama City, Panama at 0509. (Crabill, VA)
- 315:** Beacon USR, Simon Reyes, Cuba at 0511. (Crabill, VA)
- 323:** Beacon BSD, St. David's Head, Bermuda at 0028. (Crabill, VA)
- 326:** Beacon BHF, Freeport, Bahamas at 0419; Beacon PKZ, Pensacola, FL at 0117. (Crabill, VA)
- 334:** Beacon YSH, Smith Falls, Ontario, Canada at 0110. (Crabill, VA)
- 340:** Beacon BDG, Blanding, UT at 1011. (Humes, AZ)
- 344:** Beacon JA, Jacksonville, FL at 0407. (Kinsland, GA); Beacon PCH, Fresno, CA at 0910. (Humes, AZ)
- 359:** Beacon TPX, Tepexpan, Mexico at 0402. (Crabill, VA)
- 365:** Beacon JN, Muncie, IN at 0435. (Crabill, VA); Beacon FKV, Flowery Branch, GA at 0352. (Kinsland, GA)
- 368:** Beacon GYM/E, Guaymas, Sonora, Mexico. Backup xmtr at 1335. (Humes, AZ)
- 371:** Beacon ITU, Great Falls, MT at 0932. (Humes, AZ)
- 375:** Beacon TGE, Guatemala City, Guatemala at 0602. (Crabill, VA)
- 380:** Beacon UCY, Cayojoabo, Cuba at 0410. (Crabill, VA)
- 382:** Beacon UPA, Camaguey, Cuba at 0404. (Crabill, VA)
- 393:** Beacon FBG, Ft. Bragg, NC at 0905. (Humes, AZ)
- 397:** Beacon LLJ, Challis, ID at 1348. (Humes, AZ)
- 400:** Beacon NHK, Patuxent River NAS, MD at 1245. (Crabill, VA)
- 408:** Beacon HBD, Youngstown, OH at 0000. (Warrington, OH)
- 410:** Beacon DAO, Ft. Huachuca, AZ at 0655. (Crabill, VA)
- 430:** Beacon LML, Lomalinda, Colombia at 0655. (Crabill, VA)
- 434:** WLO, Mobile, AL in CW at 0210 sending 4 L/N grps, then QSX 468 kHz and off at 0216. At 0220 sent Omega navigation system advisories foll by Mississippi River navigation advisory. Off at 0300. (Kinsland, GA)
- 478:** CLA, Havana, Cuba in CW at 0151 w/Cuban Revolutionary Navy Information, wx reports and off at 0153. (Kinsland, GA)
- 484:** KLC, Galveston, TX w/tfc list at 0332, off at 0335. (Kinsland, GA)
- 516:** Beacon VPX, Pineville, WV at 1137; Beacon YWA, Petawawa, Ontario, Canada at 0306. (Crabill, VA)
- 517:** Beacon FN, Clinton, IA at 0659; Beacon GQ, Kansas City, MO at 0702. (Crabill, VA)
- 521:** Beacon GF, Cleveland, OH at 0307; Beacon GM, Greenville, SC at 0410. (Crabill, VA)
- Beacon AJG, Mt. Carmel, IL at 0832; Beacon CYV, unidentified, at 0213; Beacon HEH, Newark, OH at 0308; Beacon UOC, Iowa City, IA at 0214. (Crabill, VA)
- 2182:** Halifax CG, Canada in LSB, (no time given); VON, Canadian CG Station, Newfoundland. QSY 2598 kHz for marine info bcst. USB at 0137. (R.S., MD)
- 2714:** NBGV, USS Lexington AVT16 (off freq) using callsign Spartan clg Harbor Common New Orleans at 1100. New Orleans does not guard HF, only VHF. (Gordon, CT)
- 2716:** NDUA, USS Gato S5615 using classified callsign Zero Romeo Golf wkg Canaveral Control who using classified callsign Five Foxtrot Romeo at 1145; CZNJ, Canadian Warship HMCS Margaree DDH230 clg Charleston Navy Tug Control 0210. Margaree requested another freq higher up but Charleston only monitors 2716 kHz in HF and CH13 bridge-to-bridge; unusual callsign CGG-415.0 hrd wkg Charleston Navy Tug Control at 1025. Large exercise in Charleston Op area w/US, Canadian and NATO ships. Uniden call possibly inbound Captain's Gig which requested wx conditions in Charleston harbor; Canadian Submarine Ojibwa SS72 trying raise Charleston Harbor Control but didn't hear their response; HMCS Moresby YDT112, Canadian Navy Diving Tender attempting raise USNS Charleston at 0045. (Gordon, CT)
- 3016:** Delta 814 wkg Gander w/Selcal ck in USB at 0352. (Hamlin, NY)
- 3109:** Monterey Test wkg Sea Gull Control in USB from 0213-0326. Control giving info on two A-6 a/c scheduled for exercise but unable to fly due to mech. problems. Two F-14 a/c made ready to fly at 0250 and Monterey Test keeps asking Control when will these a/c be up. Control advises at 0322 that Sea Gull 08 is airborne, Sea Gull 09 is taxiing for t/o. At 0326 Sea Gull 09 is up and Control advises both a/c should be over range in 2 mins. (McMahan, GA)
- 3250:** YL/GG with 317 strish zero zero between 2000-05. At same time on 4780 kHz with 288 strish zero zero. Both ended with Ende. (Mason, England)
- 3258:** YL/GG in AM w/5F grps ending at 0614 foll by musical tune w/simulated churchbells for 10 secs then off air. (Fernandez, MA)
- 3319:** MGJ, British Royal Navy, Faslane w/CW mkr of "DE MGJ FREQUENCIES NOT AVAILABLE AT THE MOMENT." Checked again at 0230 and now mkr is QSX 2.4 MHz K AR. (McMahan, GA)
- 3488:** NY Radio in USB w/wx at 0445. (Warrington, OH)
- 3733:** CW stn in 80M Ham band sends 578 between 2120-2130. Then 0764f/25 = 33763/13 for 2 mins then II and into 5F grps. (Mason, England)
- 4028:** AAR5XL running MARS net in LSB, mentioned 14405 kHz as another freq. Closed net at 0200. (Warrington, OH)
- 4030:** YL/Bulgarian in AM at 0626 w/5f grps each grp x2. (Fernandez, MA)
- 4066.1:** NNQN, USS Independence CV62 wkg San Diego CSS1 at 1020 w/Autovon p/p to make. They were clg NAS Point Le Moore, CA; NROP, USS Juneau LPD10 wkg San Diego CSS1 at 0310 w/local phone call; NAEHF, USS Berkeley DDG15 wkg San Diego CSS1 at 0320 for local phone call, no answer. Call completed later re crewman w/kidney problem to be taken to Balboa Naval Hospital; NOTC, USS Caron DD970 clg Norfolk ICSB at 0025. (Gordon, CT)
- 4075/4370:** M/v Acill. Lauro, IBHE at 0943 w/pp via VIS, Sydney, Australia. (Toms, Australia)
- 4075.5:** M/v Sea Princess w/pp to U.K. re faulty ship's radar and request for parts availability. Patch made through Sydney rdo (OTC-CRS) using split 4075/4370 ship-shore freqs. The ship callsign was GBBA and vessel enroute from Sydney to Auckland, NZ. Patch was to Dekker Radio in England which must be manufacturer or supplier of radar equip. (Toms, Australia)
- 4134/4429:** 5MXH, m/v Fairstar w/pp through VIS, Sydney at 0858. (Toms, Australia)
- 4134.3:** WTDN, NOAA ship Miller Freeman R-223 clg Comsta Honolulu at 0519. NODX, USCGC Sweetbrier (WPB-405) wkg Comsta Kodiak re RTTY t/c at 0521. Both USB mode. (Sabo, CA)
- 4367:** News Reporter for TV Channel 10 on board m/v Achilles II w/Sydney-Hobart yacht race. He sending race reports via pp through VIS, Sydney. Using 4072/4367 kHz. 0829. (Toms, Australia)
- 4419.4:** Mississippi River net, OM/EE oprs w/conversations re picking up cargo. WFZ, Morgan City, LA clg Admiral Lee (ship) for relay to bromco (ship) in port. Barges mentioned, Harvey Lock and mile markers. USB mode. (McDonald, MO)
- 4426:** NMN, Portsmouth, VA in USB. OM computer voice w/wx and off at 0540. (Warrington, OH)
- 4445:** NPO, Standard Time stn in Philippines. Time pops. (McDonald, MO)
- 4483:** Australian warship HMAS Fremantle clg m/v Achilles II re bags of ice sent via m/v Omega at 2341. This was during Sydney to Hobart yacht race. Achilles II was the fleet comms vessel. (Toms, Australia)
- 4538/6963:** YL/EE in RCS w/3 = 2F grps at 0220. Note: 4538 kHz is WOM High Seas freq. (Willmer, MI)
- 4545:** Lima Victor (net control) in USB clg many 2L stns each replying w/their call and Roger, Out. Hrd at 0420. What is this? Have hrd similar comms and coded msgs here previously w/same ID's in past year. (Fernandez, MA)
- 4606:** OST, Ostend, Belgium w/unusual mkr at 0403. Mkr had callsign OST in CW and then callsign OST given in RTTY. (Yemiola, NC)
- 4637.5:** KFC699, unid in contact w/units 7-11, 14-19, and 22. Barges were carrying oil products. Unit 17 barge had accident but was not leaking. Talk re heating barges for unloading. Assume heavier oil products need be heated before unloaded. 0406. (Willmer, MI)
- 4705:** Unknown time stn w/pips 1 per sec. (McDonald, MO)
- 4740:** YL/EE rptng 15371 from 2200-05 then Ready x2 28, 28 and into 5F grps. (Mason, England)
- 4880:** YL/Czech w/5F grps. (McDonald, MO) No time given!
- 4882YL/RR** in AM 0530-0551 w/5F grps. Four msgs: 97954 23 27, 62349 49 12, 60879 13 21, and 76330 69 13. 2nd dinome is grp count. Voice xmsn preceded by 5 scaled tones rptd several times then into trinome 111 rptd several times then into t/c. Same 4 mss rptd on 4030 kHz on AM at 0550-0606. (Perez, WI)
- 4883:** YL/Czech in AM 0430-0455 w/-s. Grps preceded by 5 note tune. (R.S., MD)
- 5045:** YL/EE w/callup of 872 x3 then 1-0 count in AM at 2300. At 2310 count 182 x2 and into 3/2F grps. Rptd at 2327 and end at 2344. On another date hrd YL/EE in AM s/callup 341 x2 1-0 at 2300. At 2309:50, 10 one sec tones and at 2310 foll w/count 143 x2 and into 3/2F grps. At 2312 rptd, end at 2325. (Eager, FL)
- 5060-70:** USAF OTH-B Radar. This xmsn appeared to be test as it stayed on this freq for some time. Each burst was 10 secs long and each at a diff pulse rate w/some pulse rate changing in some bursts. While this test going on, noticed sev other xmsns scanning the lower HF spectrum. Hrd at 0645. (Fernandez, MA)
- 5206:** 5L grps in CW at 0153. (Gay, KY)
- 5263:** Unid CW stn rpts 0489 7404 3298 in slow cut-s. Off at 0030. (D.P., NC)
- 65206:** 5L grps in CW at 0153. (Gay, KY)
- 5263:** Unid CW stn rpts 0489 7404 3298 in slow cut-s. Off at 0030. (D.P., NC)
- 5320:** CG Cutter Salvia clg Commsta New Orleans w/RTTY t/c. New Orleans told them they are second in line and to stand by. The Salvia is a Buoy Tender w/call-sign NODS. Hrd in USB at 0015. (Pecora, OH)
- 5413:** YL/GG w/543 x3, 15477, 55 from 2100-05. Then 5 tones and into 5F grps. Parr w/4395 kHz. AM mode. (Mason, England)
- 5466:** SYN2 (Mossad clg) in USB at 0418, YL/EE rptd call till 0157. Nil hrd 0201. (D.P., NC)
- 5630:** SYN2, (Mossad) in AM rptng call at 0133. (Hamlin, NY)
- 5690:** DHM24, Lahr Military, GFR in USB at 0118 w/air wx till 0124. (D.P., NC)
- 5696:** Rescue 1472/Boston CG in USB w/comms re vessel taking on water. At 1637 Rescue 1472 hoisted all 3 crew, helo low on fuel, unable drop pumps. Another helo on way to drop pumps while 1472 headed for Chatham, MA airport to drop off crew (in good shape) and await fuel truck from Otis AFB for refueling before returning to base. (Fernandez, MA)
- 5870:** NAR, Key West, FL clg CQ then into 5L grps. Hrd 0230-0240. (Gay, KY)
- 6200:** NCBCE, USCGC Tahoma (WMEC-910) wkg Commsta Boston; NFBS, USS Stump DD978, and NCBG, USS Portland LSD37 both wkg Commsta Portsmouth at approx 0556; USCGC Conifer (WLB-301) at 0709 wkg CAMSPAC (vessel was anchored at Estero Bay); NRUN, USCGC Durable (WMEC-628) w/calls to Commsta Miami. All USB mode. w/Commstas answering on 6506.5 kHz. (Sabo, CA)
- 6214:** Unid CW stn at 0046 sending 5F grps using cut zero. Hand sent approx 14 gpm. Weak sig w/echo under SSB QRM, sent AR at 0056, nil more hrd, dropped 0101. (D.P., NC)
- 6216:** Two-way conversation in Italian at 0245 in LSB. (R.S., MD)
- 6223:** Raspy CW - 5dots and 1 dash rptd. Hrd 0123. (Gay, KY)
- 6226:** YL/SS in AM at 0700 w/nbrs. (R.S., MD)
- 6379:** 4XZ, Haifa Naval, Israel in CW at 0025 w/5L grps then into call tape. (D.P., NC)
- 6415:** Unid CW sta w/wx at 0253. (Warrington, OH)
- 6430:** CFH, Halifax, NS, Canada wkg C2FX in CW at 0051. CFH passes 5L grps then CQ DE CFH and into wx t/c. (D.P., NC)
- 6576:** NY ATC in LSB at 0230. (R.S., MD)
- 6648.7:** Unid CW stn at 0302 sending naval type t/c in SS. (Ed.)
- 6669.7:** ON/SS passing military type t/c in SS. Msg sent in segments on USB and other end sends CW dash to acknowledge receipt of each segment. Hrd 0223. (Ed.)
- 6693:** Two unid OM/SS oprs in USB 0212-0231 passing mixed L/F t/c. Ended each line w/"Punto Y Aparte." (Perez, WI)
- 6697:** OBI cld by OVR, both unid. USB at 0147. (D.P., NC)
- 6730:** AF1 wkg Andrews AFB in USB at 0117 w/pp to a/c maint. thru Crown re malfunctioning oil temp gauge and need to replace some carpet. AF1 returning

w/Pres. Bush from Colombia. (Hamlin, NY) AF1 and AF2 cid each other at 0335 and two OM oprs mention "Leg" and "Ambulance." Someone injured? (Blagg, IL)

**6750:** Trenton Military Radio clg Buzzsaw for rdo check. Ascension Island AFB answer w/loud and clear. Trenton said he trying contact Buzzsaw and Ascensionn YL opr said there no Buzzsaw on this freq. Trenton poss off freq?? Hrd 0211 in USB. (Pecora, OH)

**6753:** Trenton Military in SSB at 0337 passing terminal forecast, off at 0338. (Kinsland, GA)

**6756:** SAM 204 w/Congressmen and Officials on board. They on way back from Pery and El Salvador. USB at 0248. (Pecora, OH)

**6761:** Huron 30 (KC0135) in USB at 0750 wkg Crystal Palace (Wurtsmith AFB). Huron 30 passes departure msg. (Symington, OH)

**6786:** Unid CW stn sending 5F (cut nbr) grps at 0216. (Hamlin, NY)

**6788:** Unid CW stn at 0304 w/NDW TD (cut nbrs), then into 5L grps. Off at 0320 w/ EEEEE x3. (Warrington, OH)

**6844:** YL/EE in AM at 2215 reading -s. (R. S., MD)

**6890:** American observers of Nicaraguan election in USB at 0320, Managua and elsewhere, discussing rumors of a poll watcher kidnapped, a poll closed prematurely, other polls opening late. (McMahan, GA)

**7315:** AAAOUSA, AAROPN, and others, US Army MARS net in LSB mode at 2346. (Sabo, CA)

**7527:** Blue Chip in USB wkg Apple Pie in anti-smuggling ops at 2330. (McAtee, WV)

**7532:** YL/GG in USB at 2230 w/Hotel Kilo designation, then into 3/2F x2. (Willmer, MI)

**7535:** Norfolk SESEF making rdo check w/Charleston Test Control. Charleston TC doesn't guard this circuit but brought it up, for rdo check at 1700; Naval Electronics Command at Portsmouth, VA wkg Norfolk SESEF at 1930. NAVLECOM Portsmouth tests and develops USN Electronic Warfare devices for USN ships; The foll ships were hrd in equip tests w/Norfolk SESEF: NQCE, USS Raleigh LPD1, NGJS, USS Pharis FF1094; NBSZ USNS Mississinewa T-AO-144; NJFY, USS Platte AO186; NJPX, USS Nassau LHA4; NHOV, USS Saipan LHA2; NHOS, USNS Pawcatuck T-AO-108; NOUD, USS Inchon LPH12. (Gordon, CT)

**7635:** Eagle60 clg any stn on CAP CA Wing for Redcap Mission continuation tfc. USB mode at 2359. (Sabo, CA)

**7692:** Rasy CW—3 dots 1 dash rptd. Hrd at 0138. (Gay, KY)

**7706:** AOK, NavSta Rota, Spain clg CQ in CW at 0142. (Gay, KY)

**7744:** 5F grps in CW (O cut to T) from stn in comm w/another unhrd stn. 5F grps foll by AR, then UXFS K, pause KK, pause and one more 5F grp foll by K, then sign-off at 0152. (Gay, KY)

**7763:** YL/EE in AM at 0135 w/4F grps (very long spaces between grps). (Fernandez, MA)

**7830:** YL/GG rptng 938 x3 85971 119 from 1800-1805 then five tones and into 5F grps. Parallel w/5313 kHz. (Mason, England)

**7901:** AA1, VV4, poss Colombian mil stns in CW at 2320 w/plaintext SS tfc, mentions Min-Nav Bogota English exam, interested persons confirm attendance. At 2335 AA! comes up USB and QSY's net to known freq. (McMahan, GA)

**8068:** YL/SS in AM at 0936 w/5F grps. (Toms, Australia)

**8070:** SS -s stn in AM at 0100 w/callup 406 x3 and 1-0 count. (D.P., NC)

**8075:** YL/SS in AM at 1010 w/5F grps. (Toms, Australia)

**8161:** Cairns' Control to HMAS Wyalla at 1054 w/ scrambled voice comms then 'No further tfc' in plaintext English. (Toms, Australia)

**8176:** YL/EE w 1-0 count and 383 at 1800. No tones or msg. Has been hrd for 2 1/2 yrs w/ no msg. Warble jammer in background obviously doesn't know this! (Mason, England)

**8241:** WTEJ, NOAA ship McArthur (S-330) at 0217 wkg Commsta New Orleans re Fax the ship was trying to send; WRDM, NOAA ship Miller Freeman (R-223) at 0323 wkg Commsta Kodiak. Both USB mode. (Sabo, CA)

**8465:** YL/EE w/SYN2 callup in AM mode at 2328. (Mason, England)

**8506.6:** UDH, Rigou, Latvia in CW at 0120 w/CQ mkr. (GB, AK)

**8515:** 5AT, Tripoli, Libya in CW at 1707 w/mkr. (GB, AK)

**8525.7:** 9KK, Kuwait in CW at 0351 w/call mkr. (GB, AK)

**8580:** 4LSDE UQA4 in CW at 0118 w/call tape. Not listed in Ferrell's CFL, 6th ed. (D.P., NC)

**8601.5:** HEB, Berne, Switzerland in CW at 0130. Stn sent tape which announce Morse service to cease 14 April 1990. HEB will accept tfc on RT and TELEX. (D.P., NC)

**8719:** NIGP, USNS Apache T-ATF-172 wkg COMSUPRON-8 at 1145. (Gordon, CT)

**8722:** Qantas Skycomm p/patch from a/c flying over desert in Western Australia enroute to Sydney. A/c used call of Qantas 1. (Toms, Australia)

**8747:** Tokyo Radio w/test transmission (callsign JDO) at 1028. (Toms, Australia)

**8765:** USCG wx report hrd at 1030. (Toms, Australia)

**8828:** Honolulu Volmet in USB at 1207 w/automated wx best. (Symington, OH)

**8867:** Auckland Aeradio, NZ in USB at 0655 wkg United 815, a/c enroute Norfolk Is., Australia w/wx, posit report and Selcall check. (McMahan, GA)

**8912:** Holiday Inn wkg Spruce Goose in USB mode at 0252 on anti-smuggling channel YC. (Sabo, CA)

**8972:** This freq very active during shuttle launches. Have hrd NASA at Cape and the Solid Rocket Booster (SRB) Recovery vessel in Atlantic Ocean. (Morrison, FL)

**8984:** New Orleans Air to CG 1265 at 1505 in USB. A/c requesting VHF freq and given 122.95 MHz. (Watts, KY)

## Upgrade Your Scanner!

Nearly all Police, Fire & Rescue broadcasts will be moving to the 800MHz band during the next few years. Don't risk losing your ability to scan these exciting channels due to equipment frequency limitations.

GRE America, Inc. has the answer! GRE has two new frequency converters that work with your existing scanner and allows you to receive 810MHz to 912MHz on your 410MHz to 512MHz equipment. Two models are available:

◆ **SUPER CONVERTER 8001™**: The 8001 is a portable base model with Motorola antenna leads and will not interfere with reception quality. This model uses 9 volt battery or AC/DC adapter.



◆ **SUPER CONVERTER II™**: This model is perfect for handheld scanners. Has BNC connectors for fast installation, and can be returned to original frequencies at the flick of a switch. Very small and lightweight and uses a 9 volt battery or AC/DC adapter.

### Need Handheld Amplification?

◆ **SUPER AMPLIFIER™**: Adjustable 20db amplification of VHF/UHF frequencies (from 100MHz to 1GHz). Complete with BNC connectors and uses a 9 volt battery or AC/DC adapter.

◆ **GRE ALL-BAND ANTENNA™**: Attractive black with red antenna cap. BNC connector increases gain in 25MHz to 1GHz frequencies.

### Become a GRE Dealer or Distributor!

GRE America is seeking new dealers and distributors to retail a growing product line. We offer excellent profit potential at the distributor and retail levels, complete national advertising support and responsive customer service. **For more information, please call or write GRE as shown below:**



GRE America, Inc.  
425 Harbor Blvd.  
Belmont, California 94002

Telephone (415) 591-1400  
Outside CA: (800) 233-5973  
Fax: (415) 591-2001

CIRCLE 64 ON READER SERVICE CARD

# YOU AIN'T HEARD NOTHIN...YET!

Since 1967, CRB Research has been the world's leading publisher and supplier of unique hobby and professional books and information including:

- Scanner Frequency Guides
- Shortwave Frequency Guides
- Military/Federal Communications
- Broadcast Station Registries
- Undercover Communications
- Survival Communications
- Covert Operations
- Electronic Espionage
- Surveillance
- Monitoring
- Cryptography & Codes
- Bugging
- Wiretapping
- Communications Antennas
- Electronics & Projects
- Computer Technology
- & Other Related Topics!

Ask For Big Free Catalog!

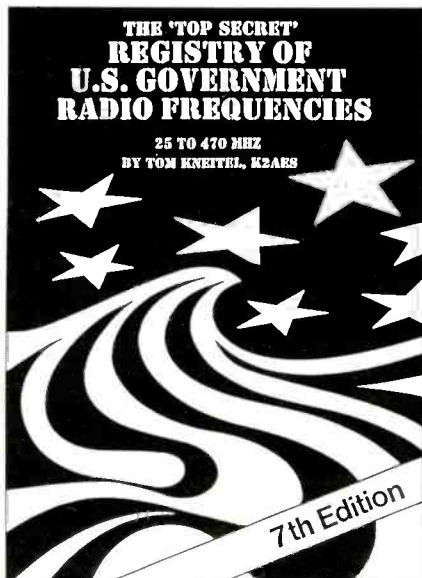

New titles are constantly being added to our exciting catalog. If it's interesting and unusual, we've got it. You'll see! Ask for our latest FREE catalog.

**CRB RESEARCH**

P.O. Box 56 Commack, NY 11725

**8993:** MAC 447 and McDill in USB comms re wx for landing at Howard AFB, Panama, p/p to Pope AFB re mechanical problems w/hydraulics and auto pilot out due enemy ground fire (this was during US Mil Ops in Panama) and mention of AWACS a/c. Many p/p's re troop shuttling, etc. (Fernandez, MA)

**9006:** Air Canada 597 wkg Trenton Military in USB at 008 w/pp to Air Canada Control. (Hamlin, NY)

**9273/10359:** YL/EE in RCS w/498 callup and 158 3/2F grps. Hrd at 0400. (Willmer, MI)

**9320:** OM/SS hrd w/5F grps. (McDonald, MO)

**10057:** CanForce 510 in USB mode at 2149 passing his flight plan to San Francisco Aeradio. 510 was a c-130 enroute to Hickam AFB. At 2150 MAC 60128 cut-in, clg SF to give position report. (Sabo, CA)

**10068:** LDOC stn Berne, Switzerland w/wx for Lisbon and talked w/TWA a/c re Time/distance and fuel to Madrid. (McDonald, MO)

**10125:** YL/EE w/Mossad xmsns. One day at 0140 rptng CIO Uniform 8. Next day at 0015 w/CIO 1 Delta. (Mason, England)

**10211:** EOY, LOR, W3D (poss USN) in USB at 2254 to 2311 discussing problems w/RTTY. After sev attempts and no joy, one stn begins giving switch settings on his equipment to the other end. S1A interrupts net to advise this sort of thing is not done over non-secure voice. Oprs decide try FAX via land line. (McMahan, GA)

**10820:** KAP2, (Mossad) in AM at 0618, YL Opr. Off at 0620. (Fernandez, MA)

**11118.6:** Group F2D, Long Beach in USB at 0032 to Cutter FOD to detain individual who dumped 2 tin cans of white powder overboard ship they had boarded. Said sheriffs were waiting at home port for their arrival. (Willmer, MI)

**11191:** 718 in contact w/713 in USB at 2208 trying locate two 40' fishing vessels that 718 had prev seen. On another day, Fine Art 713 w/msg for Hershey via Screwtop 602. Shark 03 clg Referendum 03 but no reply. 0155. (Willmer, MI)

**11200:** MVU, RAF VOLMET w/reports from remote stns beginning w/Belfast, ending w/Ascension (all missing) then RAF VOLMET. 0130. (JMS, MO)

**11214:** Century 52 via Trenton to Raymond 24 in USB at 2130. Notified Falcon 03 re mechanical failure. Requested fighters and tanker be notified they can't use them. Will fly til landing weight of 250,000 lbs achieved. Will carry out navigation training. On another day, Dragnet Tango via Trenton to Bigfoot requesting circuit on 3320 kHz for battle staff tng. Hrd 1540. (Willmer, MI)

**11222:** A/c F10254 wkg Stockholm in USB at 0207. (Hamlin, NY)

**11246:** Segó 73 (on gnd Gitmo Bay) in USB wkg MacDill w/pp to 21st Air Force w/Autovon pp in USB at 0017. (Hamlin, NY)

**11288:** Almighty and Slingshot in USB mode at 0106 on DEA channel YD. (Sabo, CA)

**11440:** Gold Mine Control wkg Gold Mine 19, 45, 46, and 49 in USB mode from approx 0229, was CA area USAF Reserve units w/emergency/disaster exercise tfc. Hope it came in handy, because the earthquake struck in CA three days later. (Sabo, CA)

**11696:** Hotel 185 wkg Hotel 187 at 0821 re set up for RTTY tfc. (McAtee, WV)

**12242:** YL/EE in AM at 0305 w/callup 422 x3 and count 1-0 until 0310, 10 tones, Count 98 x2 and into 3/2F grps. This is usually simulcast on 11463 kHz but not tonight. (Fernandez, MA)

**13008:** JOR, Nagasaki, Japan clg SBXE, unid, in CW at 1411. (Ed.)

**13207:** SAM 86972 enroute Andrews via Trenton to SAM CP. Was told to come up Jewel Box on RF2. Had QSY'd from 11214 kHz due NORAD tfc. USB at 1607. (Willmer, MI)

**13217:** Mulberry wkg Stilletto, foll by Stilletto and WAR46 (Ft. Ritchie, MD) w/calls to Faultless on Channel x-906. USB mode at 0616. (Sabo, CA)

**13247:** Mayflower clg Horsefly at 2047; Andrews wkg unid a/c w/patch to SAM Command at 0020. Both USB mode on new DOD Channel W-109. (Sabo, CA)

**13282:** Honolulu Radio w/wx, altitudes, ceilings for Los Angeles and Honolulu. (McDonald, MO)

**13312:** Saudi Arabia 005 in USB at 1600 requesting wx for Orlando and Miami from Rockwell Test Flight. (Willmer, MI)

**13330:** Houston wkg a/c N310Y re wx for CRQ (Carlsbad, CA). (McAtee, WV)

**13457:** FAA stns KCP63, Longmont, CO and KMU31, Houston, TX w/comms re RTTY testing of ASCII at 75 baud. Hrd USB at 1530. (Willmer, MI)

**13921:** YL/EE in AM at 0603 w/callup of CIO2 rptd. (Mossad) (Fernandez, MA)

**14360:** KWS78, US Embassy Athens, Greece in CW at 0050 w/CQ mkr. (D.P., NC)

**14361.7:** Polish News Agency in CW at 1446 w/news in Polish. (Ed.)

**14383.5:** NNNOCWM (NYND), USS Whipple FF1062 wkg NNNOAZT, Kaneohe, Hawaii at 0230. (Gordon, CT)

**14411.5:** NNNOCVV (NJAG), USS Yellowstone AD41 wkg NNNOUXK at 1630; NNNOCBL (NLBH), USS Long Beach CGN9 wkg NNNOCOG (NIQM), USS Enterprise CVN65 at 0230. Both were looking for a CONUS gateway stn for MARS tfc. (Gordon, CT)

**14463.5:** NNNOCOU, USS Saratoga (Attack Aircraft Carrier) wkg stateside MARS stn NNNONUW w/pp at 0343. (McAtee, WV)

**14465:** NNONAL, USS Abraham Lincoln CVN72 w/pp at 1343 and shut down at 1350. (Eager, FL)

**14470:** NNNOCUL (NGMV), USS Semmes DDG18 wkg NNOPRQ at 1610. (Gordon, CT)

**14495:** Mechanical-sounding OM/EE with 3/2F grps in USB at 0400. (Hamlin, NY)

**14818.5:** USNS Leroy Grumman T-AO-195 w/Fleet Electronic Warfare Support Group deployed aboard using their MARS callsign NNNONOF wkg NNNONUW at 0020. (Gordon, CT)

**15867:** Maverick 33 and 37 (a/c) wkg Slingshot (FL AFB) in USB at 1725 re radar targets/vectors/tracking. (Fernandez, MA)

**18002:** McClellan AFB in USB at 2205 wkg unid stn w/wx observation. (Symington, OH)

**186334.4:** CLP1, Minrex Havana, Cuba clg CLP55, Tripoli, Libya in CW at 1355. Told 55 to QSY 17480 and then QSY 20570. Nil hrd both freqs. (Ed.)

**19154.8:** Musical tones in a 2 stanza tune (7 then 5 tones) rptd in AM at 1912. (Fernandez, MA)

**19881:** USMC, MARS stns NNNOMOQ and NNNOMJM in USB at 0052. (Sabo, CA)

**20185.8:** Shuttle Columbia on orbit 65 over South Africa w/news conf via Mission Control Houston re successful recovery of Long Duration Exposure Facility. 1405. Next day video down-link of Fluid Experiment Assembly and Tread Mill experiment. 1756. USB mode. (Willmer, MI)

**20997:** USN MARS stns NNNONUW, Whidbey Island NAS, WA and NNNOCNH, USS New Jersey BB62 in USB mode at 0046. (Sabo, CA)

**21000:** Planet Jupiter radio emission (wave sounds in 1-3 sec oscillations). ID'd from info in article in "Sky and Telescope" magazine. Hrd in AM at 0300. (R.S., MD)

**21754:** Hot House (a/c) w/pp thru Cliffhanger to Bell Tone, Tiddley Winks, Willy Winkle, and others, in USB mode at 2020. (Sabo, CA)

**21964:** Honolulu Aeradio wkg Singapore-2 and Express-71 at 2201. United 809 at 0144 w/position report to Honolulu. (Sabo, CA)

**22262:** URB2 DE EVR4 in CW at 1253 sending 5F wx tfc. (D.P., NC)

**22409:** JOR, Nagasaki, Japan in CW at 0030 w/CQ mkr. (JMS, MO)

**32463:** JCU, Chosi, Japan in CW at 0024 w/CQ mkr. (JMS, MO)

**22524:** JFA, Chuo Gyogyo, Japan in CW at 0018 w/CQ mkr. (JMS, MO)

**23138:** 5F grps in Croatian (Yugoslav) in AM at 1213. OM opr left air abruptly 1233 w/carrier remaining on for several secs. Prev hrd same xmsn in 1989. (Toms, Australia)

**23343:** Ambush and Angry Warrior in USB at 3 = 2311 w/several pp for deployed personnel. Calls made to several stateside AFB's. At 2330 net QSY'd to Sierra 05 (found on 21990 kHz). At 2332 net QSY's again, this time to Sierra 09 (lost them). (McMahan, GA)

**23402.5:** Atlas wkg unid stn w/pp in USB mode at 1846. (Sabo, CA)

**27554.8:** Calls of 107 (W. Virginia), 138 (Texas), 367 (Calif.) and B4WD (unid) in LSB at 2330. Many stns wkg, does not appear be any Net Control stn. Stns mainly just saying hello to each other and complaining about QRM. Not all stns in EE (mention of a Puerto Rican stn) and SS heard. Chatter much like Ham oprs. Stns faded by 0058, dropped. (D.P., NC)

## Tape Recorder And Timer For World Band Radio Listening

A tape recorder or tape deck, plus a timer, are useful adjuncts to the radio listening post. Whether you are a program listener or a DX'er there are several important applications helpful to all with a number of others that may meet the needs of your personal listening activities and installation.

Recording your favorite programs when you are away from the house is a top priority. Most of us who are relatively active in radio listening average about one program a day we would prefer not to miss. On other occasions two good shows overlap and you can listen to one on your portable while the other can be taped from your table-top receiver. When there is a special program on the air you can tape it while you listen. It may be replayed later on and even become a part of a permanent collection of especially good shows. Outstanding music programs, anniversary shows and other special events are three examples. When you are not at home during showtime, operate your set and recorder off of a timer.

The recording capability helps you maintain a high enthusiasm for shortwave listening. However, you can't be listening day and night. There is family, work and other interests too that need your attention. Many worthwhile shows may be missed if you can't record them. Some of the seldom used and questionable features on modern receivers could be eliminated in favor of a built-in timer and tape recorder.

Many of you like to send in musical requests, bits of information you wish to convey over listener participation shows and mailbag questions. However, stations do not send you any on-the-air specific reply day. If you don't listen to each program until your request is answered, you are likely to miss it. What a boon a recorder/timer hook-up is in this situation! Otherwise you may never hear their answer to you.

How often do you miss an address given over the air? I expect there are more missed than copied correctly. A recorder in your station set-up gives you a chance to copy the correct address.

### DX'er

The shortwave DX'er is wise to have a recorder turned on whenever DX'ing. Station ID's sometimes occur quickly, are widely spaced in time, and are often in a fade or troubled with a crack interference just when the station announcement is made. If you are listening to a foreign language station, the problem is more difficult. An example is a very weak South American station in static. The recorded station breaks you copy are often of tremendous help. Run the tape over the announcing period several times and you can often decipher the ID.

In medium wave DX'ing, the stations fade in and out quickly on the same frequency. Call letters come through one on top of the

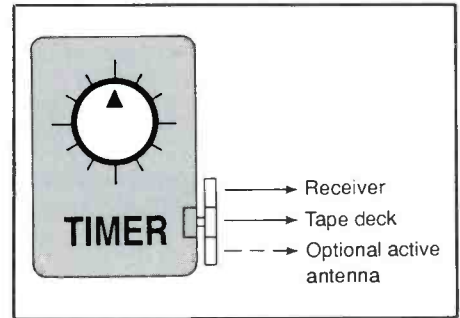

Fig. 1. Timer arrangement for timing three pieces of equipment.

other, and it can be tough to get the call letters straightened out. This applies especially to the crowded local channels with their many stations and low-power transmitters. Two exciting times to DX on the medium wave band is an hour or two before and after sunset. The same applies at dawn. Turn on the recorder when you are listening actively for new stations during these periods.

If you collect QSL cards your problem of setting down an accurate program sequence became easy with a recording facility.

(Continued on page 42)



Fig. 2. Time and three outlet sockets.



Fig. 3. Receiver and tape deck cords connected to timer.

# POP'COMM's World Band Tuning Tips

August, 1990

**T**his Pop'Comm feature is designed to help you hear more shortwave stations. Each month this handy, pull-out guide will show you when and where to tune to hear a wide variety of local and international broadcasters currently active on the shortwave radio bands.

Note that the languages used will not always be English and that broadcasts may not necessarily be beamed to North America. Keep in mind that stations frequently make changes in broadcast times and frequencies. Changes in propagation conditions may also make certain broadcasts difficult or impossible to receive at times.

All times given are in UTC.

| Freq. | Station/Country              | UTC Notes               | Freq. | Station/Country           | UTC Notes               |
|-------|------------------------------|-------------------------|-------|---------------------------|-------------------------|
| 3200  | TWR, Swaziland               | 0300 sign on            | 6090  | R. Luxembourg             | 2330                    |
| 3225  | R. Occidente, Venezuela      | eves SS, 0400 close     | 6105  | Tus Panteras, Mexico      | 1145 SS                 |
| 3270  | Radio Namibia                | 0400                    | 6116  | Voz del Llano, Colombia   | eves SS                 |
| 3300  | R. Cultural, Guatemala       | 0230 SS/EE              | 6130  | R. Portugal               | 0600 PP                 |
| 3320  | R. Suid Afrika, S. Africa    | 0300 Afrikaans          | 6135  | Swiss Radio Int'l         | 0130                    |
| 3370  | R. Tezulutlan, Guatemala     | 0100 SS                 | 6140  | ABC, Australia            | 0900                    |
| 3380  | R. Chortis, Guatemala        | 0130 Indian lang        | 6150  | Caracol, Colombia         | eves SS                 |
| 3380  | R. Iris, Ecuador             | 0200 SS                 | 6165  | R. Netherlands            | 0030 via Bonaire        |
| 3385  | R. East New Britain, PNG     | 1200 Pidgin             | 6175  | BBC, England              | eves                    |
| 3480  | V of Nations Saving          | 1115 Korean clandestine | 6185  | WRNO, New Orleans         | 0400                    |
| 3965  | RFI, France                  | 0500 FF                 | 6248  | Vatican Radio             | 0300 various langs.     |
| 4300  | R. Moderna, Peru             | eves SS                 | 6305  | Voz del CID               | eves anti-Cuba          |
| 4485  | Petropavlosk R., USSR        | 1200 RR                 | 6400  | V of the Strait, China    | 1000 CC                 |
| 4755  | R. Educaco Rural, Brazil     | 0100 PP                 | 6540  | R. Pyongyang, N. Korea    | 1000 JJ                 |
| 4760  | ELWA, Liberia                | 0600 EE                 | 6955  | R. Beijing, China         | 1100 VV                 |
| 4790  | R. Atlantida, Peru           | 0400 SS                 | 6995  | Radio Beijing, China      | 1100 various            |
| 4800v | R. Buenas Nuevas, Guatemala  | 0200 Mam                | 7115  | Radio Moscow, USSR        | eves World Service      |
| 4810  | SABC, South Africa           | 0300                    | 7125  | AWR, Italy                | 0600 various langs.     |
| 4815  | R. Guatapuri, Colombia       | eves SS, irregular      | 7145  | R. Polonia, Poland        | 0400 Polish             |
| 4820  | HRVC, Honduras               | eves SS/EE              | 7165  | Radio Liberty, W. Germany | 0100                    |
| 4832  | R. Reloj, Costa Rica         | eves SS                 | 7190  | DYBS, Dem. Yemen          | 0300 AA                 |
| 4840  | R. Valera, Venezuela         | eves SS                 | 7205  | R. Australia              | 1200                    |
| 4850  | CRTV, Cameroon               | 0430 sign on            | 7255  | V of Nigeria              | 0500 sign on            |
| 4851  | R. Luz y Vida, Ecuador       | eves SS                 | 7265  | Sudwestfunk, W. Germany   | 0700 GG                 |
| 4870  | ORTB, Benin                  | 0500 FF, sign on        | 7300  | R. Tirana, Albania        | 0000                    |
| 4880  | Radio Five, So. Africa       | 0300 EE                 | 7325  | BBC, England              | eves                    |
| 4915  | GBC-1, Ghana                 | 0530 sign on            | 7340  | Voz del CID               | eves anti-Cuba          |
| 4940  | R. Continental, Venezuela    | eves SS                 | 7345  | R. Prague, Czechoslovakia | eves                    |
| 4955  | R. Cultura, Brazil           | 0200 PP                 | 7365  | WHRI, Indiana             | eves                    |
| 4996  | R. Andina, Peru              | 0400 SS                 | 7370  | Turkey Police Radio       | 0500 TT                 |
| 5015  | Estacion Tarapoto, Peru      | 1000 SS                 | 7375  | RFPI, Costa Rica          | 0100 USB                |
| 5020  | SIBC, Solomon Is.            | 0830                    | 7400  | R. Kiev, Ukraine          | 2300                    |
| 5025  | Rebelde, Cuba                | eves SS                 | 7412  | All India Radio           | 1200                    |
| 5044  | R. Impacto, Costa Rica       | eves SS                 | 7430  | Voice of Greece           | eves EE/Greek           |
| 5286  | R. Moundou, Chad             | 0500 FF                 | 7440  | R. Moscow                 | 0430                    |
| 5875  | BBC, England                 | eves various langs      | 7445  | Voice of Asia, Taiwan     | 1100 EE/CC              |
| 930   | R. Prague, Czechoslovakia    | eves EE, others         | 7475  | RTT Tunisia               | 0430 AA                 |
| 5945  | R. Austria Int'l             | 2230                    | 9022  | VOIRI, Iran               | 0400 various langs.     |
| 5955  | R. Havana, Cuba              | eves SS                 | 9045  | Iran's Flag of Freedom    | 0330 anti-Iran          |
| 5956  | RBI, E. Germany              | 0445 PP, GG, etc.       | 9280  | WYFR/Family Radio         | 1200 via Taiwan         |
| 5975  | BBC, England                 | eves via Antigua        | 9345  | R. Pyongyang, N. Korea    | 1000 RR                 |
| 5980  | R. Guaruja, Brazil           | 0830 PP                 | 9360  | Spanish National Radio    | 0100 SS                 |
| 6000  | R. Guaiaba, Brazil           | 0800 PP                 | 9385  | Voice of Greece           | 0100 Greek/EE           |
| 6005  | CFCX, Canada                 | 0830                    | 9400  | R. Iran                   | 0200 anti-Iran          |
| 6015  | R. Austria Int'l             | 0500 via Canada         | 9410  | BBC, England              | 0300                    |
| 6020  | R. Netherlands               | 0030                    | 9445  | Voice of Turkey           | 2300                    |
| 6025  | R. Amanecer, Dom. Rep        | 1000 SS                 | 9465  | WMLK, Pennsylvania        | 0400                    |
| 6030  | R. Santa Maria, Chile        | 0900 SS                 | 9470  | R. Cairo, Egypt           | 0200                    |
| 6040  | Voice of Germany, W. Germany | 0100 via Antigua        | 9500  | R. Tirana, Albania        | 0000                    |
| 6050  | HCJB, Ecuador                | 0600                    | 9505  | Radio Japan               | 1200 JJ/EE              |
| 6055  | R. Continental, Peru         | 0930 SS                 | 9515  | XEWX, Mexico              | 1215 SS, irregular      |
| 6065  | Super Radio, Colombia        | 1100 SS                 | 9520  | R. Budapest, Hungary      | 0030 Hung/EE            |
|       |                              |                         | 9525  | Radio Marti, USA          | eves SS to Cuba via VOA |



| Freq. | Station/Country              | UTC Notes              | Freq. | Station/Country              | UTC Notes               |
|-------|------------------------------|------------------------|-------|------------------------------|-------------------------|
| 9535  | TWR, Bonaire                 | 0300                   | 15240 | R. Veritas Asia, Philippines | 1215 II/CC              |
| 9555  | La Hora Exacta, Mexico       | 1230 SS                | 15255 | R. Bucharest, Romania        | 0100                    |
| 9565  | La Voz de la OEA, USA        | 2345 SS via VOA        | 15280 | KGEI, California             | 0100 SS                 |
| 9565  | R. Universo, Brazil          | 0200 PP                | 15300 | UAE, Radio, UAE              | 1700 AA                 |
| 9575  | RAI, Rome                    | 0100 EE                | 15315 | Radio Netherlands            | 0030 via Antigua        |
| 9580  | R. Australia                 | 1200                   | 15325 | Radio Norway Int'l           | 2300 NN                 |
| 9590  | Radio Netherlands            | 0330                   | 15330 | RTM Morocco                  | 2030 AA                 |
| 9600  | R. Tashkent, Uzbek SSR       | 1200                   | 15335 | All India Radio              | 1330                    |
| 9605  | Radio Denmark                | 2300 via Norway        | 15345 | RAE, Argentina               | 1800 various langs.     |
| 9605  | Vatican Radio                | 0030                   | 15365 | Radio RSA, So. Africa        | 0400 FF                 |
| 9615  | KGEI, California             | 0315 SS                | 15375 | Spanish National Radio       | 1900 EE/FF              |
| 9630  | R. Aparecida, Brazil         | 0130 PP                | 15390 | BBC, England                 | 0400 SS, via Ascension  |
| 9635  | Radio Canada Int'l           | 1300                   | 15400 | UAE Radio, UAE               | 1700 AA                 |
| 9640  | R. Finland Int'l             | 1515                   | 15400 | Radio Finland Int'l          | 1300                    |
| 9660  | R. Yugoslavia                | 2200                   | 15420 | WRNO, New Orleans            | 2100                    |
| 9690  | RAE, Argentina               | 0100                   | 15425 | SLBC, Sri Lanka              | 1515                    |
| 9695  | Radio Sweden                 | 0200                   | 15430 | R. Austria Int'l             | 1200                    |
| 9700  | Radio Moscow                 | 0200                   | 15440 | RBI, East Germany            | 2330 SS                 |
| 9715  | R. Baghdad, Iraq             | 0400 AA                | 15455 | R. Moscow                    | 1900                    |
| 9740  | R. Portugal                  | 2000 PP                | 15470 | R. Tashkent, Uzbek SSR       | 1200                    |
| 9745  | HCJB, Ecuador                | 0100                   | 15475 | Africa No. One, Gabon        | 1800                    |
| 9755  | RCI, Canada                  | 0000                   | 15485 | Radio New Zealand Int'l      | 0300                    |
| 9785  | KTWR, Guam                   | 1200 JJ                | 15490 | Radio Kuwait                 | 0300 AA                 |
| 9800  | Radio France Int'l           | 0100 SS                | 15505 | Radio Kuwait                 | 1400 AA                 |
| 9835  | R. Budapest, Hungary         | eves                   | 15525 | Radio Moscow                 | 0300 SS                 |
| 9870  | R. Austria Int'l             | 0000 GG/SS/EE          | 15535 | Peace and Progress, USSR     | 1300 EE                 |
| 9925  | BRT, Belgium                 | 0030                   | 15560 | Radio Netherlands            | 1630 Dutch              |
| 9965  | R. Caiman                    | eves anti-Cuba         | 15575 | Radio Korea, S. Korea        | 1400 KK                 |
| 10010 | V of Vietnam                 | 1100 various langs.    | 15585 | Peace and Progress, USSR     | 0300 PP/SS              |
| 10330 | All India Radio              | 1330                   | 15605 | R. Pakistan                  | 1315 Urdu               |
| 11100 | CPBS, China                  | 1130                   | 15630 | Voice of Greece              | 1200 Greek              |
| 11550 | RTT Tunisia                  | 1700 AA                | 15650 | KUSW, Utah                   | 1600                    |
| 11580 | Voice of America             | 0000                   | 15710 | CPBS, China                  | 1000 CC                 |
| 11670 | Peace & Progress, USSR       | 0300 PP/SS             | 17387 | All India Radio              | 1200                    |
| 11705 | R. Bangladesh                | 1315 various langs.    | 17540 | Voice of Unity               | 11600 anti-Afghanistan  |
| 11705 | Radio Sweden                 | 0200                   | 17555 | WSHB, S. Carolina            | 1400 Christian Science  |
| 11720 | R. Sofia, Bulgaria           | 0400                   | 17560 | RTBF Belgium                 | 1900 Dutch              |
| 11725 | RFE, W. Germany              | 0500 Polish            | 17595 | RTM Morocco                  | 1400 FF                 |
| 11734 | R. Tanzania-Zanzibar         | 1800 Swahili           | 17605 | Radio Netherlands            | 1430                    |
| 11735 | R. Yugoslavia                | 0100                   | 17620 | R. Moscow                    | 0100                    |
| 11745 | V. of Free China             | 0200 via WYFR          | 17620 | Radio France Int'l           | 2300 SS                 |
| 11760 | R. Cook Islands              | 0600                   | 17630 | Africa No. One, Gabon        | 1500 FF                 |
| 11780 | R. Nacional Amazonas, Brazil | 2130 PP                | 17665 | R. Minsk, USSR               | 2330                    |
| 11805 | R. RSA, So. Africa           | 0500 Afrikaans         | 17680 | Radio Beijing, China         | 1100                    |
| 11810 | All India Radio              | 1200 various langs.    | 17680 | Radio New Zealand Int'l      | 0600                    |
| 11835 | R. Anhanguera, Brazil        | 0130 PP                | 17705 | Radio Denmark                | 2230 Danish, via Norway |
| 11840 | R. Japan                     | 1200 JJ/EE             | 17715 | Radio Nacional, Colombia     | 0100 SS, irregular      |
| 11860 | BBC                          | 0330 via Ascension Is. | 17725 | Radio Pakistan               | 0230 EE                 |
| 11900 | HCJB, Ecuador                | 0000 Quechua           | 11730 | Spanish National Radio       | 1700 SS                 |
| 11905 | RAI, Rome                    | 0330 RR                | 17735 | Radio Oman                   | 1430 AA                 |
| 11910 | Radio Havana, Cuba           | 0100 SS                | 17740 | Radio Sweden                 | 1300 EE/Swedish         |
| 11930 | TWR, Bonaire                 | 0300                   | 17755 | Radio Japan                  | 0100 JJ                 |
| 11940 | R. Bucharest, Romania        | 0200                   | 17775 | KVOH, California             | 1900 EE/SS              |
| 11980 | KSDA, Guam                   | 1100 CC                | 17790 | HJCB, Ecuador                | 1800 various langs.     |
| 11990 | R. Prague, Czechoslovakia    | 0100                   | 17795 | Radio France Int'l           | 1600 EE/FF              |
| 12010 | R. Tikhy Okean, USSR         | 0815 RR                | 17800 | RAI, Italy                   | 1400 Italian            |
| 12020 | TWR Monaco                   | 1515 various langs.    | 17815 | Radio Cultura, Brazil        | 0100 PP                 |
| 12035 | Swiss Radio Int'l            | 0115                   | 17820 | Radio Canada Int'l           | 1800 FF/EE              |
| 12077 | Voice of Israel              | 1800 Hebrew, others    | 17825 | Qatar Broadcasting Service   | 0245 AA                 |
| 13605 | V of the UAE                 | 2100 AA                | 17830 | Swiss Radio Int'l            | 1315 various langs.     |
| 13610 | RBI, E. Germany              | 0500 GG                | 17835 | Radio Havana Cuba            | 1800 SS/PP              |
| 13655 | R. Jordan                    | 0530                   | 17855 | Radio Beijing, China         | 0300 EE/CC              |
| 13665 | R. Pakistan                  | 1200                   | 17860 | BBC                          | 1515 via Ascension      |
| 13700 | R. Netherlands               | 0430                   | 17870 | Vatican Radio                | 1300 PP/SS              |
| 13720 | KSDA, Guam                   | 1200 various langs.    | 17875 | HCJB, Ecuador                | 2100 PP/JJ              |
| 13740 | RTBF, Belgium                | 0500 FF                | 17880 | Radio Sweden                 | 1430 various langs.     |
| 13760 | WSHB, So. Carolina           | 0000 Christian Science | 17890 | UAE Radio, UAE               | 0230 AA/EE              |
| 13810 | ISBS, Iceland                | 1410-1440 Icelandic    | 17895 | Radio Liberty, W. Germany    | 1400                    |
| 14918 | R. Kiribati, Kiribati        | 0600                   | 21460 | RTBF Belgium                 | 1600                    |
| 15020 | All India Radio              | 1330 vern.             | 21470 | HCJB, Ecuador                | 2000 various lang.      |
| 15060 | BSKSA, Saudi Arabia          | 1800                   | 21475 | Radio Austria Int'l          | 1200 various langs.     |
| 15095 | Vatican Radio                | 1430 various           | 21485 | Vatican Radio                | 1300 PP/SS              |
| 15105 | V of Germany, W. Germany     | 0030 via Antigua       | 21495 | Radio Portugal               | 2000 PP                 |
| 15110 | Spanish National Radio       | 0000 EE/SS             | 21515 | RAI, Rome                    | 1500 Italian            |
| 15120 | Radio RSA, So. Africa        | 0200                   | 21525 | Radio Australia              | 1300                    |
| 15130 | Radio Beijing                | 2300 via Mali          | 21565 | RFPI, Costa Rica             | 2100                    |
| 15140 | Radio Nacional, Chile        | 2200 SS                | 21590 | Radio RSA, So. Africa        | 1500                    |
| 15165 | Radio Denmark                | 11230 DD via Norway    | 21605 | UAE Radio, UAE               | 1600 AA/EE              |
| 15180 | Radio Norway                 | 200 NN                 | 21610 | Radio Sweden                 | 1430                    |
| 15185 | WINB, Pennsylvania           | 2100                   | 21650 | Vatican Radio                | 1515 various langs.     |
| 15190 | Lao National Radio           | 110 Lao, via R. Moscow | 21657 | Radio Kuwait                 | 1600 AA                 |
| 15220 | Radio Budapest               | 0300 SS                | 21790 | Voice of Israel              | 1400 various langs.     |
| 15225 | BBC, England                 | 1700                   | 21840 | WHRI, Indiana                | 1600                    |
| 15235 | R. Jamahiriya, Libya         | 2215 II/CC             | 25730 | Radio Norway Int'l           | 1400 NN                 |
| 15240 | R. Australia                 | 0030                   | 25820 | Radio France Int'l           | 1500 FF                 |



## You Should Know

(from page 63)

ty. Tune in the news coverage of the station and tape it. At your leisure you can copy out the exact sequence of items covered on your QSL request. It represents an ideal way of confirming the fact that you indeed heard the station at the particular time.

In fact, you can use any exact sequence of material that will make a positive identification of the stations program content over a reasonable length of time.

If you become actively involved with tapes, number both sides of your tapes and keep records of their content. Most short wave broadcast programs are one-half hour or one hour in length. Thus, the most popular tapes are 60 minute (30 minutes per side) and 120 minute (1 hour per side) sizes. There is a place on the label to mark UTC time and date as well as frequency and program name. Do it first in pencil if you are not certain you wish to keep the broadcast permanently. If so, the information can be erased easily and the tape side used again and relabelled.

In activities involved in obtaining QSL requests, several stations can be done on one side. Again, you can show times, dates, and frequencies, as well as signal readings. Pencil them on the label or in a notebook, or label on the QSL request in ink. Then copy an

appropriate program sequence on the QSL request. Do add some program opinions, too. The importance of maintaining contact with the program department, producer and presenter was mentioned in a previous column.

In DX'ing, you can use some of your older tapes. Keep them running as you tune about for DX stations. However, when you make an ID, jot the time down immediately as well as other essential items. Also, get an adequate program sequence together immediately if you plan to make an SWL request. You can come up with your own request form and have copies made. Consequently, you are always ready to jot down the necessary information.

### Timer/Recorder Set-Up

The simple set up is a 10-year old Sharp tape deck, timer and an R-2000 receiver, Fig. 1. The plug-in timer, Fig. 2, is a cordless Radio Shack (63-862) unit that plugs into the wall socket. It has a single outlet, but I have found a triple output a-c socket can be plugged into it. From here, Fig. 3, two a-c cords connect the receiver and the tape deck. An active antenna, when needed, can be plugged into the third outlet. The timer is rated at 7.5 amperes, while the three units draw less than 2 amperes.

A regular small tape recorder/player can be used instead of a tape deck. I prefer the

tape deck because of the ease with which the proper signal level can be adjusted for a good recording by using its LED signal level display. To listen to the program I recorded, I use another tape player.

When DX'ing I do use this regular small tape recorder/player because it can be re-wound with ease in trying to decipher the location of the incoming weak DX signal. When so doing, it, too, can be plugged into the third outlet of the AC socket.

The timer can be programmed very easily. It is calibrated in half-hour intervals over a 24 hour day. It has facilities for two on/off cycles. Most often only one such cycle is needed for the usual shortwave broadcast application. On occasion you may wish to pre-set two programs. First, I present the one or two turn on/off intervals. This is usually a convenient number of hours before program time. Then I set the timer clock to an exact hour. Using the WWV signal, I then plug it into the socket at this exact time. The clock will then run and at the pre-set time it will turn on the equipment for a particular program and turn it off in a half hour, or one hour, or a longer period after the start time. Don't forget, you must have the receiver tuned to the desired station.

A recorder/timer is an extra station feature that will permit you to enjoy shortwave broadcast activities a bit more because you can put programs on tape that usually you would not hear because of other activities.

# ICOM's IC-R9000 . . . . . . The Best Of Both Worlds

The pacesetter IC-R9000 truly reflects ICOM's long-term commitment to excellence. This single-cabinet receiver covers both local area VHF/UHF and worldwide MF/HF bands. It's a natural first choice for elaborate communications centers, professional service facilities and serious home setups alike. Test-tune ICOM's IC-R9000 and experience a totally new dimension in top-of-the-line receiver performance!

**Complete Communications Receiver.** Covers 100KHz to 1999.8MHz, all modes, all frequencies! The general coverage IC-R9000 receiver uses 11 separate bandpass filters in the 100KHz to 30MHz range and precisely-tuned bandpass filters with low noise GaAsFETs in VHF and upper frequency bands. Exceptionally high sensitivity, intermod immunity and frequency stability in all ranges.

**Multi-Function Five Inch CRT.** Displays frequencies, modes, memory contents,

operator-entered notes and function menus. Features a subdisplay area for printed modes such as RTTY, SITOR and PACKET (external T.U. required).

**Spectrum Scope.** Indicates all signal activities within a +/-25, 50 or 100KHz range of your tuned frequency. It's ideal for spotting random signals that pass unnoticed with ordinary monitoring receivers.

**1000 Multi-Function Memories.** Store frequencies, modes, and tuning steps. Includes an editor for moving contents between memories, plus an on-screen notepad for all memory locations.

**Eight Scanning Modes.** Includes programmable limits, automatic frequency and time-mark storage of scanned signals, full, restricted or mode-selected memory scanning, priority channel watch, voice-sense scanning and scanning a selectable width around your tuned frequency. Absolutely the last word in full spectrum monitoring.

**Professional Quality Throughout.** The revolutionary IC-R9000 features IF Shift, IF Notch, a fully adjustable noise blanker, and more. The Direct Digital Synthesizer assures the widest dynamic range, lowest noise and rapid scanning. Designed for dependable long-term performance. Backed by a full one-year warranty at any one of ICOM's four North American Service Centers!

The ICOM logo consists of a large, stylized letter 'O' on the left, followed by the letters 'I', 'C', 'O', and 'M' in a bold, sans-serif font. The 'O' is significantly larger than the other letters and has a small circle inside it.

**First in Communications**

ICOM America, Inc., 2380-116th Ave. N.E., Bellevue, WA 98004  
**Customer Service Hotline (206) 454-7619**  
3150 Premier Drive, Suite 126, Irving, TX 75063 /  
1777 Phoenix Parkway, Suite 201, Atlanta, GA 30341  
ICOM CANADA, A Division of ICOM America, Inc.,  
3071 - #5 Road, Unit 9, Richmond, B.C. V6X 2T4 Canada

All stated specifications are subject to change without notice or obligation. All ICOM radios significantly exceed FCC regulations limiting spurious emissions. 9000489

## FOCUS ON FREE RADIO BROADCASTING

**Zodiac Radio** has been closed down by the FCC. The station was operated by 36 year old James Keul for a period of two or three months. The transmitter was an amateur-type unit he'd picked up at a swap meet. Broadcasts were mostly on 7416 and included such features as Orson Welles' "War of the Worlds" and polka music. Zodiac Radio was based in Anaheim, California. Keul was fined \$1,000 after the FCC had earlier issued him a warning to stop broadcasting.

**The Voice of Anarchy** says it operates on 26694 using a "Bleak Model 13 AM/CW transmitter" made by the "Kowalski Radio Company of Chicago in 1948." The unit was supposedly built for use by the British Armed Forces. The station says its antenna is a half wave dipole "atop a tall building in Chicago". The transmitter has 50 watts output and the station says it was purchased at a flea market for just \$2 still in its original box. Hmm. I think a collector would have paid a hefty sum for a rare item like that!

**WXZR** and several other stations had a long networking session which was heard by Walter R. Talbot II and Thomas Gabriel, both in Pennsylvania. This was around 0615 and 7414 and included **Radio Mexico International** (using both Spanish and English), **Pirate Radio International**, apparently based in Kentucky and **WTNU**, which talked about plans for a European DX'pedition with possible operations between 15020-15050. Other bits picked up by Walter and Thomas included the fact that the Slanesville, West Virginia address was to change to P.O. Box 109, Blue Ridge Summit, PA 17294. . . . WTNU gave its address as 261 LeHigh Road, Baltimore, MD or care of Richard Cranium, Suite 196, 4431 LeHigh Rd., College Park, MD (no zips given out, I guess). WXZR noted that WKND, Zodiac Radio, Secret Society Radio, WLBR and WHBH were all recently busted by the FCC. Other frequencies used for this networking party were 7401 and 7416.

**WXZR** was heard by Sam Rimell in Virginia at 0100 on 7405, ID'ing as Neontological Research Radio and playing a tape of telephone company messages. They announced the new Blue Ridge address.

Joshua D. Wilkes of Kentucky found **WGAR** on 7415 at 0320 with a recorded Hare Krishna sermon. Off at 0340. Apparently this one is located in the Gary, Indiana area but I haven't seen an address for it yet.

**KMUD** was heard by "Cutler" in California on 7435 at 0500 with pop music and "squishy, muddy" sound effects. Claims to running 20 to 30 watts output. Wilkes' QSL from this station notes the broadcast he

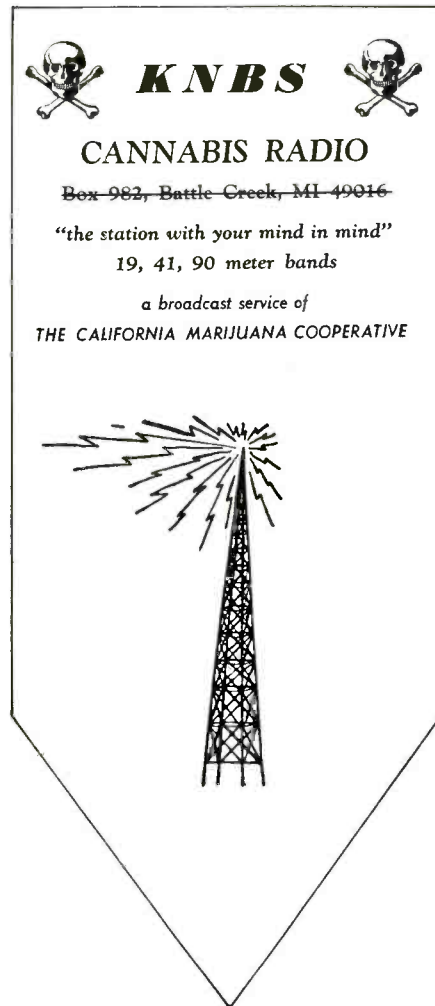

This paper pennant is sent out with KNBS QSL's.

heard was probably one of their last as the operator was moving to Hawaii. He may go on the air from Hawaii, however.

Wilkes' heard **WMEX** on 7432 with old commercials, jingles and "that's all folks" at closing, though they were on and off the air several times throughout the evening, says Joshua.

Robert Ross of Ontario checks in with his usual fine list of pirate logs (and QSL's). Bob heard **WLAR** on 7425 at 2210-2236 sign off. Box 452, Wellsville, NY 14895 given for reports. Included talk about golfing, letters, phone calls and a Dr. Ruth spoof.

**WENJ** was heard by Robert on 7416.1 at 0124-0241 sign off with DJ Jack Beane playing oldies and ID'ing as "J-Rock USA." Phone number given as (201) 525-7920 as well as an 800 number for New Jersey.

**Radio USA** was found on 7415.6 at 0155 sign on with a 7th anniversary broadcast hosted by Mr. Blue Sky. The original in-



terval signal was aired, along with recording from earlier programs, says Bob Ross.

Bob heard **Samurai Radio** on 7450 at 2155 and 7375 at 2240-2241 sign off. The operator seemed to be in contact with Mr. Blue Sky on 7450 as there was some banter back and forth. Also found briefly on 7375 with the now outdated Slanesville address and a suggestion to check for them later on 19 meters, though Bob found nothing there.

Ross has **Radio Garbanzo** on 7411.5 at 0232 with a commercial for the 1990 Pirate Radio Directory, blues and rock, commercials and a synthesized voice.

**Radio Orang-Utang**, operating from Holland, was heard by Ross from 0811 on 6206. They gave the address (phonetically) as Box 114, Schoorenborg, Holland. The program was a mix of talk and music with several ID's. There's always an extra kick in hearing those Europirates, right Bob?

And, Bob reports several pirates QSL'd received: Hope Radio International sent a form letter signed by Jamie, Chief Operating Engineer; Radio USA QSL'd from the Wellsville drop and Bob also had replies from Radio Stella International, Samurai Radio and the Voice of Laryngitis.

Despite the FCC busts in recent months, pirate radio activity continues to be quite high. All it takes to get your share of pirate logs is some consistent tuning of the pirate frequency segments, especially 7300-7500 and especially on the weekends.

A reminder that I'm always looking for your pirate loggings and QSL information as well as other pirate radio news. Pirate operators are encouraged to write and let me know about your programs, equipment and other activities.

See you back here in the Den next month!

## The Pirate Scene

Pirate broadcasters have always held the interest of the monitoring hobby. Right now, there probably more FM and SW pirates operating than ever before, many of them being busted in one of the FCC's periodic blitzes on unlicensed broadcasters. Regardless of which side your cheering for, the basics of the battle are that it's clearly against the law to broadcast without a license, but there's no law against just listening to the stations. And many people have come to find that listening to these stations (and collecting QSL's from them) is an exciting aspect of monitoring, for they are often pretty weird. Even if the extent of your interest is purely academic, wondering which ones will be shot out of the saddle by the FCC's posse, there's never a dull moment in the eerie world of underground broadcasting.

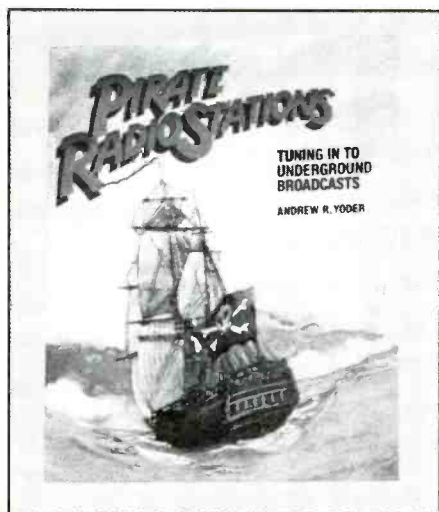

Andy Yoder, one of the better known observers of the pirate scene (you've seen his by-line on features about pirate radio in POP'COMM, and he also published his own newsletter on the topic) has written his first lengthy (182-page) and in-depth chronicle of pirate broadcasting dating back to the 1920's, and bringing it right up to today's most active stations. The book is brimming over with pirate station facts, frequencies, photos, as well as station QSL's and addresses. Various chapters zero-in on specific categories of pirates, like those that operate only on holidays, those that have a political philosophy (usually crackpot) to hawk, and so on. He explains "utility" pirates in another chapter, then tells how to collect pirate station QSL's. Extracting QSL's from some of these stations is an art and science in itself, and Yoder's instructions are the best we have seen yet.

The book is called *Pirate Radio Stations*, and we'd say that it never ceases to be informative or hold the interest. It's well written, too. It's the most comprehensive study yet

done done on the species and, as much, we heartily recommend it to you.

This isn't to say that there weren't several places in Yoder's book that didn't cause us to raise our eyebrows and say, "Huh?" For instance, on page 35, Yoder pays reverence to ACE (The Association of Clandestine Enthusiasts) and notes that this was the beginning of an "actual movement" in pirate radio, and that ACE's publication was the first time that a national club was dedicated to reporting on pirate activity. Yoder curiously ignores the earlier *Free Radio Campaign*, and its publication, *Wavelength*. FRC existed for several years, beginning in the 1970's, and had more than 100 members. When ACE was created, many (or most—or perhaps all) of its founders were former FRC members. Indeed, the loss of those members from the ranks of the earlier group undoubtedly contributed to FRC's demise. To now attempt to rewrite history by not mentioning FRC, and awarding ACE historic credentials to which it isn't entitled is not only unfair, but also plainly inaccurate.

Another eyebrow raiser related to the information given on the world's first offshore pirate, which was afloat in 1933 aboard the S.S. *City of Panama* off the California coast. The station's callsign was RXKR. In all 26 places that Yoder mentions the callsign, it is given incorrectly. This was obviously not an isolated typographical goof, but an error in Andy's basic research.

In at least one spot, Yoder even shoots himself in the foot. On page 170, while extolling the benefits of reading club newsletters over and above the monthly magazines, he proclaims that "magazine information is not usually as accurate as that of the newsletters, because pirate articles are often written by professional writers and not free radio listeners." With Yoder's own book and several magazine credits, he fits the criteria for being a professional writer. Does that mean he is not really a "free radio listener"? Is that the reason for the several inaccuracies we spotted? He doesn't explain why being a professional writer, in his opinion, precludes a person from monitoring pirates, or writing about them.

We don't mean to be hypercritical, because *Pirate Radio Stations* is a well-intentioned and worthwhile book. The flaws we found didn't detract from Andy Yoder's book, but they were worthy of noting, if for no other reason than to highlight the wonderful unintentional humor of his preposterous statement about professional writers. Hey, Andy, after all, none of us are human!

*Pirate Radio Stations*, by Andrew Yoder, is available from CRB Research Books, Inc., P.O. Box 56, Commack, NY 11725. The book is \$12.95 plus \$2 postage and handling to addresses in North America.

Residents of NY State, please add 98 cents sales tax.

## Radio Fiction

We haven't enjoyed radio-related fiction since *Tom Swift And His Radio Controlled Grandfather*, but we kind of enjoyed a new book entitled *Night Signals*, by Cynthia Wall, KA7ITT. To be sure, this isn't Drei-

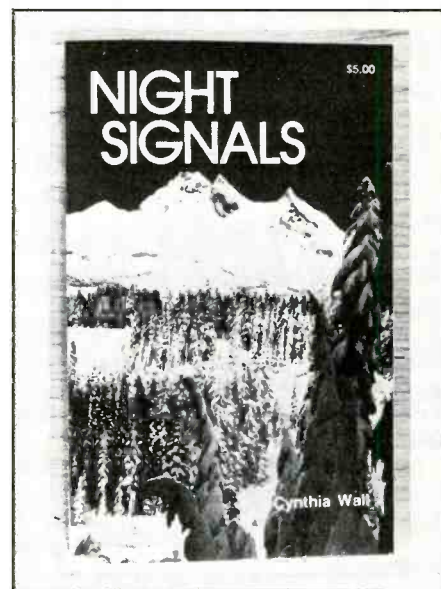

ser's *An American Tragedy*, but it doesn't strive to be more than a few evenings worth pleasurable diversion for those who like radio.

Without fear of giving away any major plot twists, essentially this is the story of Kim, KA7SJP, a teenage YL from Oregon. She has a QSO with an OSU student who is hiking in the wilderness. They set up a sked for the following night, but Marc is a no-show. That's because he's had all sorts of unfortunate and unexpected things take place in his life resulting in a broken leg and (even worse) a broken power supply. If that weren't bad enough, the next day things get really bad.

As the story develops, quite excitingly, from there, Marc demonstrates his ingenuity with communications equipment. At the other end of the circuit, Kim's concern with the fellow who didn't keep the sked causes her to contact various agencies in an effort to report problems he might be having in the wilds of Oregon. That eventually brings out a coordinated effort by the ARES, the National Guard's Jeep Patrol, a sheriff's department, the Oregon Mounted Pose, and others to locate Marc.

This is a 168-page book. It makes good reading, and should be able to be enjoyed by adults, and even youngsters from 12 and up who are hams, SWL's, CB'ers, or have an interest in getting started in communica-

tions. Would be a good gift for the technology-oriented youngster you know who is into computers and would be an asset to communications, if only he or she could catch the spark of enthusiasm. This could do the job.

*Night Signals* is \$5.00, plus \$2 postage and handling, from the ARRL, 225 Main Street, Newington, CT 06111.

### Hot Hams

The *DRONK Radio Network* is a group of ham operators concentrated in Southern California, but scattered throughout the English-speaking world. To celebrate their 20th anniversary, but mostly for reasons of gastronomic enjoyment, the group has issued its unique *Ham Radio Cookbook*, by W.K. Cheverton, WB6ZQZ.

The *Ham Radio Cookbook* has 147 recipes of all sorts of main dishes, breads, desserts, candies, salads, appetizers, and beverages. Many are credited to members of the organization, and just about all appear to be mouth-wateringly good (the color photos of many help). I must admit, however, that *Garlic Breath Pasta* and *Grilled Sweetbreads* were just a shade beyond my own personal taste parameters. Some are pretty funny, and require that certain utensils be pre-heated by placing them on top of a radio cabinet. Recipe #49 (*Dummy Load Casserole*) suggests the heat from a dummy load.

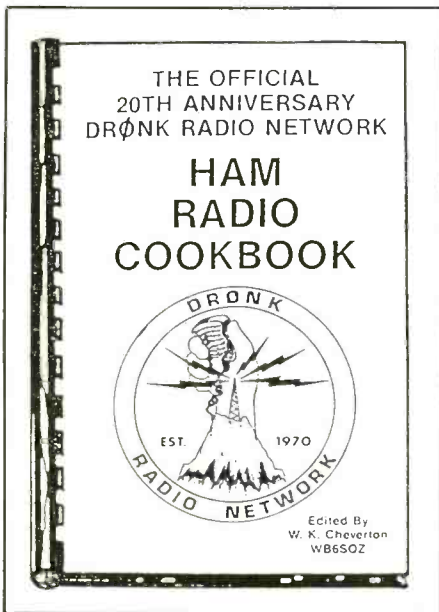

This is a cookbook after my own heart. I'm definitely going to try my hand at many of these things. Judging from the scorch marks on my wall, I'd say that the finals in my transmitter can probably cook a steer on the hoof at 20 paces in less than five minutes.

You can get your own copy of the *Ham Radio Cookbook* for \$5.00 plus \$1.50 postage and handling. Order it from W.K. Cheverton, Box 85234, San Diego, CA 92138-5234. Checks must be made payable to W.K. Cheverton.

PC

FREE  
SAMPLE  
COPY!

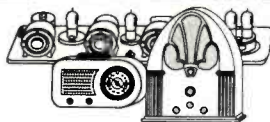

### ANTIQUE RADIO CLASSIFIED

*Antique Radio's Largest-Circulation Monthly Magazine*

Articles - Classifieds - Ads for Parts & Services

Also: Early TV, Ham Equip., Books, Telegraph, 40's & 50's Radios & more...

Free 20-word ad each month. Don't miss out!

Free Sample. 6-Month Trial - \$13.

1-Year: \$24 (\$36 by 1st Class). Foreign - Write.

A.R.C., P.O. Box 802-T6, Carlisle, MA 01741

CIRCLE 71 ON READER SERVICE CARD

FREE CATALOG!  
1-800-648-7938

JERROLD HAMLIN OAK ETC

CABLE TV  
EQUIPMENT

- Special Dealer Prices!
- Compare our Low Retail Prices!
- Guaranteed Prices & Warranties!
- Orders Shipped Immediately!

REPUBLIC CABLE PRODUCTS, INC.

4080 Paradise Rd. #15, Dept. 109  
Las Vegas, NV 89109

For all other information (702) 362-9026

CIRCLE 163 ON READER SERVICE CARD

For 25 years,  
our people have  
endured long hours  
and tough  
working conditions  
for no pay.



And 9 out of 10 would  
do it again.

TO FIND OUT WHY

call

(316) 263-2100

or write

REACT INTERNATIONAL, INC.

242 Cleveland

Wichita, KS 67214

CIRCLE 43 ON READER SERVICE CARD

# TELEPHONES ENROUTE

BY TOM KNEITEL, K2AES

## WHAT'S HAPPENING WITH CELLULAR, MARINE & MOBILE PHONES

**W**e are beginning to see an ever-increasing number of newspaper classified ads for used ("pre-owned") cellular phones being offered by individuals. While the majority of these are undoubtedly legitimate resales offered by original owners who are seeking to get rid of the equipment, at least some of them are likely ads for the many cellulators that are now being stolen along with other pieces of mobile electronics such as tape decks, CD players, CB radios, speakers, etc. Of course, some cellulators also make their way into the ("still new, never used, in unopened carton") resale market after having been pilfered from inventory stock of legitimate dealers and distributors by employees, or ripped off during burglaries. Certainly, any piece of new or used electronics equipment being offered by an individual at too outstanding a price should be immediately suspect as to its recent ancestry.

While there is a thriving market in all types of used autosound equipment, cellulators must be regarded somewhat differently than buying a used or "never used" CD or tape deck from an unknown individual. Assuming the equipment works, CD's and tape decks can be installed and put directly to use. Cellulators, however, present a number of different obstacles that must first be tackled by those who purchase them in used, "never used" condition from unknown individuals. Because many well-meaning people think that such offerings represent a cheap way of finally getting a car phone, or perhaps obtaining an inexpensive cellular for a second vehicle, a few words of caution are definitely in order.

If a person wants to place calls from their boat through the "marine operator," a VHF-FM marine radio can be purchased in new or used condition and put into use with very little effort or bother. They can operate right away while waiting for the FCC to process the license. If they were placing only "collect" calls, there is no need to even open a billing account with the marine operator. A CB radio in your car or boat requires even less effort. Nobody has any way of knowing the circumstances of the existence of either piece of gear in the past.

Before a cellular phone will work, however, it must be issued a distinctive "telephone number" by a company which will be handling its billing accounts, sending it calls, and receiving calls from the unit. This number is usually programmed into the cellular by an authorized equipment dealer, who also is an agent permitted to open a billing account for either or both local cellular service suppliers.

The mere fact that a prior owner once



*The new Audiovox PT-300 handheld has some fine features.*

opened an account and consequently had a valid telephone number programmed into the unit, is absolutely meaningless to the person hoping to purchase the unit in used condition. Even if it is a legitimate resale, the new owner will have to contact either the local wireline or non-wireline cellular carrier company in the hopes of opening a new billing account, and getting a different number programmed into the cellular. The previous number won't work any longer. This also means going through a rather stringent credit check. There's a better than 50/50 chance that the individual selling the cellular owes a sizable unpaid bill on his account and his service was shut off, which is why he is selling the unit.

If the set was stolen from a car, or burglar-

ized in new condition from a dealer or distributor, then all sorts of bells and whistles are going to go off as soon as there is an attempt made to open a billing account anywhere. Every cellular telephone has a unique serial number permanently programmed into its memory circuits by the manufacturer. This number can't be reprogrammed, modified, or changed in any way throughout the life of the unit. When the unit is sold, registered with a cellular service company, or repaired by a service technician, the unique serial number is a vital part of the identification of the unit. The serial number of every cellular ever reported stolen or burglarized is recorded and known to all service suppliers. You can imagine what happens when someone buys a bargain cellular from an unknown in-

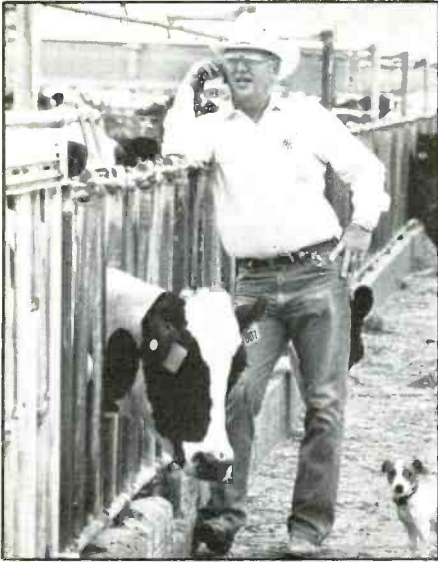

Bill Rezzonico chats on his handheld cellular while running his dairy in Gilbert, Arizona.

dividual and than innocently shows up in the hopes of getting his little gem registered for use in North America. Even if it disappeared two years earlier from a dealer's shelves 2,000 miles away, it will be instantly flagged as a fugitive.

Stolen or burglarized cellulars are totally worthless. It's therefore best to purchase only from legitimate dealers (many offer used equipment) who will not only vouch for the ancestry of everything they sell, but provide a bill of sale, also take care of opening a billing account and programming the newly assigned telephone number into the unit. Buying from an unknown individual is, at best, risky on several levels since (even if the equipment is legit) it may require major repairs. The person considering the purchase of a cellular from an unknown individual seller should demand a copy of the bill of sale showing when/where the seller obtained the unit. To be doubly sure that the unit was not stolen or burglarized, the serial number can be checked with a local cellular service supplier before the purchase. If the owner can't supply a bill of sale, forget the deal. If he doesn't want the serial number checked, report him to any cellular telephone company as someone attempting to sell a set you suspect might be stolen.

## Privacy Report

The column received a very interesting and well-prepared report entitled *Cellular Party Line Of The 90's*, put out by the Cellular Security Group, 4 Gering Road, Gloucester, MA 01930. The lengthy report was prepared by Thomas Bernie (Amateur K0TB/1), who heads up the CSG and speaks before groups on how to talk over cellulars without compromising the privacy of business deals and personal matters.

Tom Bernie's report is being distributed to the news media with the intention of making the average cellular user aware that, despite

the fact that public has been allowed to wallow in the misconception that cellular calls are private and secure, quite the opposite is the truth of the matter. Of course, persons involved in communications have known this all along and POP'COMM's pages have discussed this at length. In fact, Tom Bernie's report contains many quotes from and other references to POP'COMM, as we are a goldmine of information on the subject of electronic privacy invasion.

It's about time the public woke up to the fact that the "expectation of privacy" that they talk about has no logical reason to be considered when making references to any unsecured communications system such as cellulars. Maybe Tom Bernie's worthwhile report will be picked up by the media and the message will finally get through. Then they can send the ECPA back over the rainbow to the *Land of Oz* from whence it came — along with the munchkins who conceived that legislative monument to stupidity and public gullibility.

## Cellulars 'Till The Cows Come Home

Among the latest commercial users to pick up on the advantages of cellulars are agricultural users. *U.S. West Cellular*, a major Arizona cellular carrier, advises that sales figures show cellular use among farmers in the agricultural services industry have increased more than 85% since 1985.

Rancher Bill Rezzonico, of Rezzonico Ranches in Gilbert, AZ says that he can't recall how he ever got along without his handheld portable. He's constantly on the go, and has to be able to coordinate his hay sales and dairy operations no matter whether he's in his truck, in the barn, or out in the pens. He says, "It's not unusual to see me out in the middle of the herd of dairy cattle using the phone to arrange hay deliveries."

Dr. Steven Smalley, a large-animal veterinarian, also finds cellular a boon to his activities. Headquartered in Chandler, AZ Smalley's practice spans from Buckeye to Florence, so much of his time is spent on the road. Last year, he was on his way to an emergency, when another critical problem popped up in Gilbert. The cellular enabled him to arrange to deal with both situations.

The files at *US West Cellular* are filled with many examples of how cellulars are finding new uses daily in agricultural applications. In many instances, they are replacing VHF walkie-talkies, CB radios, and other communications modes that had been in use recently.

## Pocketful Of Miracles

Audiovox Corporation just brought out the PT-300 handheld cellular portable. One of the special features of this set is its ability to receive incoming calls even when the antenna is retracted down into the body of the set.

Another nifty feature is its secret memory,

which stores credit card and other important numbers that can be accessed only by inputting a special three-digit code. Silent incoming calls let you know if your receiving an expected call without disrupting a meeting. The LCD display simply flashes the word "call," so you don't become the center of attention as the ringer goes off in the middle of your boss's speech.

The PT-300 has other features, too. like multiple-city registration, 99 alphanumeric memory locations, last number redial, automatic storage, emergency 911 dialup in all modes, and easy-to-read high-tech graphics on the keypad. The 0.6 watt portable comes complete with battery pack and desktop battery charger. Options include a leather carrying case and a battery eliminator which permits the PT-300 to be operated through your vehicle's cigarette lighter.

This is quite a fine little set and looks like it does just about everything except send out the monthly check to your cellular company. The MSRP is \$795, and it sounds like a lot of radio.

For more information on the PT-300, contact Audiovox, 150 Marcus Blvd., Hap-pauge, NY 11788, or circle 102 on our Readers' Service.

This column seeks your questions about telephones on-the-go, also anecdotes about uses and applications of mobile and marine telephones. We also invite information from manufacturers and service suppliers. **PC**

### SUPER LONG PLAY TAPE RECORDERS

**12 Hour Model — USES D-120 TAPE \$119.00\***

Modified Panasonic Slimline, high quality AC-DC provide 6 continuous hours of quality recording & playback on each side of cassette for 12 hours total. Includes • Voice level control • Digital counter, etc. TDK D-120 Cassette Furnished.

**PHONE RECORDING ADAPTER**

Records calls automatically. All Solid state connects to your telephone jack and tape recorder. Starts recording when phone is lifted. Stops when you hang up. **\$28.50\*** FCC APPROV

**VOX VOICE ACTIVATED CONTROL SWITCH**

Solid state. Self contained. Adjustable sensitivity. Voices or other sounds automatically activate and control recorder. Uses either recorder or remote mike. **\$28.50\***

\*Add for ship & hdlg. Phone Adapter & Vox \$1.50 ea. Recorders \$4.00 ea. Cal. Res. add tax. Mail order, VISA, M/C, COD's OK. Money Back Guarantee. Qty. disc. avail., Dealer Inquiries invited. Free data.

**AMC SALES INC.** Dept. P 9335 Lubec St. Box 928. Downey, CA. 90241. Phone (213) 869-8519 FAX (213) 923-1478





# JULY BOOK BUYS



## ANTENNAS

### BEVERAGE ANTENNA HANDBOOK by Victor Misek, W1WCR

Misek delves deep into the secrets of the single wire Beverage and SWA (Steerable Wave Antenna) with helpful hints and tips on how to maximize performance based upon wire size, height above ground, overall length and impedance matching. Transformer design information for both termination and feedline matching is completely revised. ©1987 80 pages 2nd Edition.

VM-BAH Softbound \$14.95

### YAGI ANTENNA DESIGN by Dr. James Lawson, W2PV

W2PV was known world-wide as one of the most knowledgeable experts on antenna design and optimization. Loop antennas, The effects of ground, Stacking, Practical design and Practical Amateur Yagi antennas. Every Ham should get a copy for their bookshelf. ©1986 1st edition.

AR-YD Hardbound \$14.95

### THE AMATEUR RADIO VERTICAL HANDBOOK by Cpt. Paul H. Lee, USN (Ret.), N6PL

Based upon the author's years of work with a number of different vertical antenna designs, you'll get plenty of theory and design information along with a number of practical construction ideas. Included are designs for simple 1/4 and 5/8-wave antennas, as well as broadband and multi-element directional antennas. ©1984, 2nd edition.

CQ-VAH Softbound \$9.95

### W1FB's ANTENNA NOTEBOOK by Doug DeMaw, W1FB

Antennas have been one of DeMaw's passions in Amateur Radio. He has worked with countless designs of all shapes and configurations. This fully illustrated book give you how-to instructions on a number of different wire and vertical antennas. Also includes information on radial systems, tuners, balun and impedance transformers. ©1987 120 pages.

AR-AN Softbound \$7.95

### LOW BAND DX'ING by John Devoldere ON4UN 2nd Edition

Based upon years of practical on-the-air experience, learn the secrets of how ON4UN has been so successful on the low bands. Extensive coverage is given to transmit and receive antennas. Dipoles, inverted V's, slopers, phased arrays and Beverages. Also covered: propagation, transmitters, receivers, operating, software and an extensive Low Band bibliography.

AR-UN Softbound \$9.95

### EASY-UP ANTENNAS for Radio Listeners and Hams by Ed Noll W3FJQ

This book covers basic do-it-yourself antennas for SWL's, AM and FM BCB'ers, present and prospective Hams and scanner listeners. Includes dipoles, verticals, beams, long wires, and several special types and configurations. Also has time saving look-up dimension tables, constants and other helpful hints for antenna design. 1st edition 164 pages ©1988.

22495 Softbound \$16.95

### NOVICE ANTENNA NOTEBOOK by Doug DeMaw W1FB

NoVICES have long wondered what is the best all around antenna for them to install. Up until now, this was a difficult question to answer. Aimed at the newly licensed Ham, DeMaw writes for the non-engineer in clear concise language with emphasis on easy-to-build antennas. Readers will learn how antennas operate and what governs performance. Also great reading for all levels of Amateur interest. 1st Edition ©1988.

AR-NAN Softbound \$7.95

### ANTENNAS by John Kraus, W8JK

Kraus' classic antenna book has been extensively revised and up-dated to reflect the latest state-of-the-art in antenna design and theory. Includes over 1,000 illustrations and nearly 600 worked examples and problem solutions. Chapters cover basic concepts, print sources and point source arrays, dipoles, helices, broadband and frequency independent antennas, special applications and tons more of information. 2nd edition 917 pages ©1988.

MH-35422 Hardbound \$59.95

### ARRL ANTENNA BOOK by Jerry Hall, K1TD, 15th Edition

The 15th edition of this antenna classic represents over two years of hard work by editor K1TD. It's doubled in size too--from over 300 to over 700 pages big! 950 figures and charts cover just about every subject imaginable. Some of the highlights are: Chapters on Loop antennas, multi-band antennas, low frequency antennas, portable antennas, VHF and UHF systems, coupling the antenna to the transmitter and the antenna, plus p-l-e-n-t-y more. 15th edition 900+ pages ©1988

AR-AM Softbound \$17.95

### ANTENNA IMPEDANCE MATCHING by ARRL

One of the most comprehensive books ever written on the use of Smith charts in solving impedance matching problems. 224 pages full of helpful information and solutions to tricky matching problems. ©1989.

AR-IMP Hardbound \$14.95

### ARRL ANTENNA COMPENDIUM by ARRL Staff

QST gets far more antenna articles than it can publish. This collection is taken from the best submissions and represents a wide range of subjects -- from quads and loops to general information -- this book has it! ©1985 1st Edition.

AR-AC Softbound \$9.95

### ANTENNA COMPENDIUM Vol. 2

includes MS-DOS program listings

Antennas are the #1 topic of interest among amateurs. ARRL annually receives far more antenna articles than it can use in QST. So, they decided to publish them in THE ANTENNA COMPENDIUM. These never before published articles run the range from simple, easy-to-construct antennas to sophisticated designs. Six program listings are included. You can also get the programs on a MS-DOS disk for an additional charge. ©1989 1st edition 208 pages.

AR-AC2 Softbound Book Only \$11.95

FAR-AC2 (MS-DOS) Disk Only \$9.95

AR-FAC2 BUY 'EM BOTH SPECIAL Book & Disk \$17.95

## by W6SAI & W2LX

RP-WA WIRE ANTENNA HANDBOOK - Wire antennas for all installations \$11.95

RP-CQ ALL ABOUT CUBICAL QUAD ANTENNAS - "The" quad book \$ 9.95

RP-VA ALL ABOUT VERTICAL ANTENNAS - Everything you want to know \$10.95

RP-AH THE RADIO AMATEUR ANTENNA HANDBOOK - Complete guide to antennas \$11.95

**HAM RADIO BOOKSTORE** \* Software Orders - Don't forget to tell us which computer you have \*  
CATALOG #M90  
GREENVILLE, NH 03048

Now a division of CQ Communications, Inc.

Orders 603-878-1441

(8 am to 5 pm EDST)

FAX - 24 Hr. Hot Line 603-878-1951

SAVE TIME & MONEY

SHOP BY MAIL

OR CALL TODAY!



## 1990 EDITIONS

### 1990 RADIO AMATEUR CALLBOOKS

#### NORTH AMERICAN EDITION

Fully updated and edited to include all the latest FCC and foreign government call signs and addresses for Hams in North America. Includes plenty of handy operating aids such as time charts, QSL bureau addresses, census information and much more. Calls from snowy Canada to tropical Panama. Now is the time to buy a new Callbook when you'll get the most use out of your investment. ©1989

CB-US90 Softbound \$27.95

#### INTERNATIONAL EDITION

QSLs are a very important part of our hobby. All sorts of awards, including the coveted DXCC, require confirmation of contact before the award can be issued. Of special interest, addresses are being added daily for Hams in the USSR and other countries. While by no means complete, it's a start and will be of tremendous help in getting QSLs. Handy operating aids round out this super book value. ©1989

CB-F90 Softbound \$29.95

## JULY SPECIAL - BUY 'EM BOTH

CB-USF90 Reg. \$57.90 Only \$49.95 SAVE \$7.95

### THE 1990 ARRL HANDBOOK

Revised and updated with the latest in Amateur technology, now is the time to order your very own copy of the world famous ARRL HANDBOOK. In addition to being the definitive reference volume for your Ham shack, there are plenty of projects for every interest in Amateur Radio -- from antennas for every application to the latest state-of-the-art projects -- you'll find it all in the 1990 HANDBOOK. Over 1100 pages ©1989.

AR-HB90 Hardbound \$22.95



## NEW BOOKS



### 1990-91 ARRL REPEATER DIRECTORY

Bigger and better! Over 14,000 listings including 1400 digipeaters -- every Ham should have a copy of this book in their car or shack. Handy resource book has listings by frequency and location. Invaluable aid while travelling. ©1990.

AR-RD90 Softbound \$5.95

AR-2RD90 (Buy 2 & Save) \$9.95

### MICROWAVE HANDBOOK - Components and Operating

Techniques, Vol. 1

edited by M. W. Dixon, G3PFR

The microwave region has experienced an explosion in interest in the last few years. This new RSGB book contains simple and easy-to-understand theory explanations, projects and practical designs that have been tested and debugged. Includes: operating techniques, system analysis and propagation, antennas, transmission lines and microwave semiconductors and tubes. Great reference book! ©1989

RS-MHB Softbound \$34.95

### RADIO AMATEUR CALLBOOK SUPPLEMENT

both NA and DX listings

Includes all the latest calls and address changes for hams around the world. Invaluable aid to getting coveted QSLs from rare DX stations. This is the only way to be fully up-to-date. Over 300 pages ©1990.

CB-SUP90 Softbound \$9.95



## NEW SOFTWARE



### MFJ EASY-DX Program and Packet interface

(MS-DOS computer)

Here's a unique tool that organizes your DXCC quest into a simple easy-to-use format. Enter a call. Easy-DX gives you azimuth and sunrise-sunset time. It also tells you whether or not you need the contact for a new country, band or mode. Packet radio users get a built-in terminal program designed to make the most of Pavilion Software's Packet Cluster™ system or any other packet node. When connected, Easy-DX alerts you when a country you need is spotted. Comes on two 5.25" disks. Hard drive recommended. Latest version will be shipped.

FMFJ-EDX (MS-DOS) \$39.95

PLEASE ENCLOSE \$3.75 FOR SHIPPING AND HANDLING

## WHAT'S HAPPENING: INTERNATIONAL SHORTWAVE BROADCASTING BANDS

**W**e are all well aware that shortwave broadcasts are an excellent way of keeping up with what's going on in the world. But, content aside, one can often get a pretty fair idea of what's happening just by taking note of what's happening with stations themselves. Revolution comes to Romania and suddenly Radio Bucharest becomes Radio Romania International. Namibia achieves independence and Radio Southwest Africa is transformed into Radio Namibia.

Radio Vilnius offers a less happy example. An Associated Press story indicates that the station's overseas broadcasts have been "blocked by Radio Moscow." We worked a bit with Paul Courson, the AP Radio News reporter behind that piece of information, helping check frequencies used for the Radio Vilnius North American service. A day or so after the Lithuanian parliament declared independence from the Soviet Union the normally well received Radio Vilnius signal virtually disappeared. The only frequency in use was 12060 and it was weak and

covered by a loud hum. Apparently, the station made an announcement on this broadcast stating that their access to transmitting facilities provided by Moscow had been cut and that they were using a low power transmitter of their own which was being jammed. A day or two later the noise on 12060 had been replaced with a relay of Radio Kiev and Radio Vilnius remains unheard, at least at our location.

All this change in Eastern Europe and Soviet Union has some US higher ups beginning to look at making changes in our government's shortwave broadcasting via the Voice of America and RFE/RL. According to an AP story the National Security Council is going to review things and perhaps establish a presidential commission to offer recommendation as to the long term future of these stations. Some members of congress are suggesting that the "mission" of the stations needs to be changed.

Two new private shortwave outlets are on the air from Italy. The Voice of Europe is

said to be running a 24 hour a day schedule on 7566. It's been heard by some US and Canadian DX'ers. The other station is Radio Europe, operating from the Milano area on 7295 on weekends between 0800-1100.

Stimme der DDR (Voice of the DDR), the East German home service, has become "Deutschlandsender." It's on in German from 2300-0530 on 6115 using the same facilities as Stimme der DDR did. Whatever the name the 50 kW transmitter is very difficult to hear, due largely to heavy QRM almost always present in this area. We can look to more dramatic changes on the German shortwave broadcasting scene as the move to reunification progresses.

As part of its 15th birthday celebration, the Ontario DX Association got a new set of call letters for the club's ham radio station: VE30DX. The club plans to put the station on the air on the 15th of each month through February, 1991. Hams who work the station or SWL's who log it can obtain a special commemorative QSL certificate

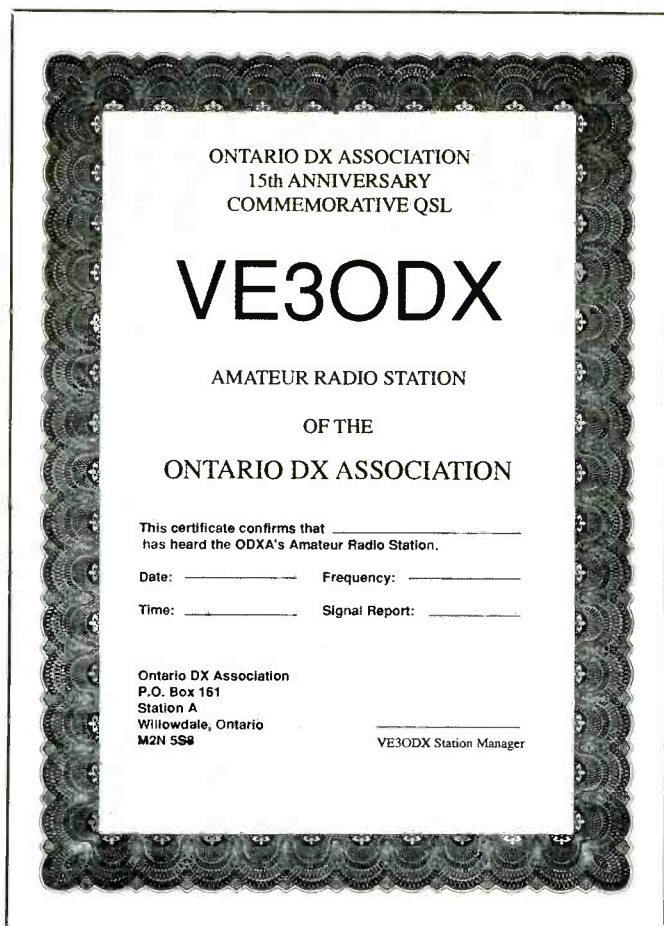

Ontario DX Association's 15th Anniversary Commemorative QSL certificate.

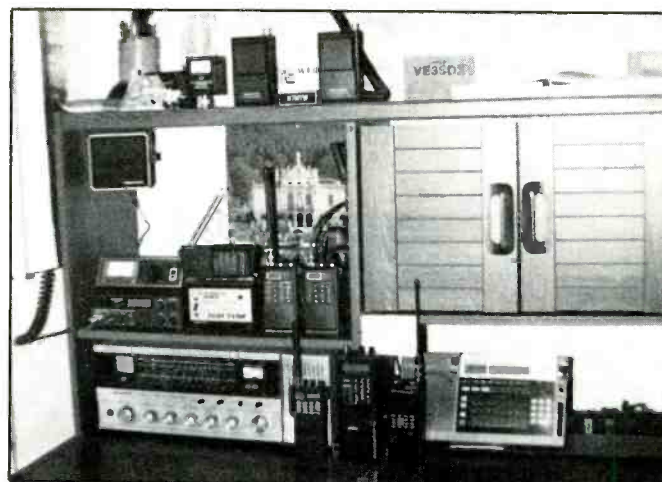

Here's the shack of N7MWY—Jim Ross in Vancouver, Washington—a regular Listening post reporter.

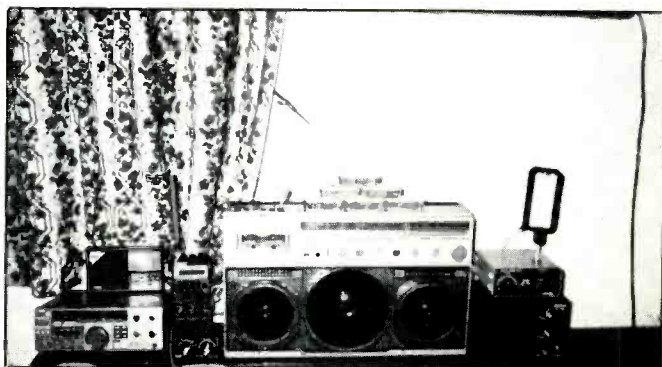

Hugh Waters operates this bedside listening post from his home in Singapore.



This is the first of the quarterly QSL's for 1990 issued by Trans World Radio, Bonaire. It depicts a typical 19th century Bonaire home.

(see illustration). VE30DX will be active on the 15th of each month between 21150-21250, 14100-14200, and 7050-7100. SWL's are encouraged to supply very accurate reception reports, which should be sent to Stephen Canney, 2952 Bayview Avenue, Willowdale, Ontario M2N 5K6. Sample copies of the club's fine monthly bulletin can be had from P.O. Box 161, Station A, Willowdale, Ontario M2N 5S8. Send along a couple of bucks to cover their costs. Two other Canadian SWL clubs have ham stations: The Canadian International DX club (VE3SWL) and the Club Ondes Cortes du Quebec (VE2COC).

Chuck Roswell, frequency coordinator for Trans World Radio, Bonaire and also host of the station's "Bonaire Wavelength" DX show has announced the series of QSL cards to be used by the station this year. Four designs feature very attractive drawings of scenes on Bonaire. Reports to Trans World Radio, Bonaire, Netherlands Antilles.

MAIL CALL - Again comes the question

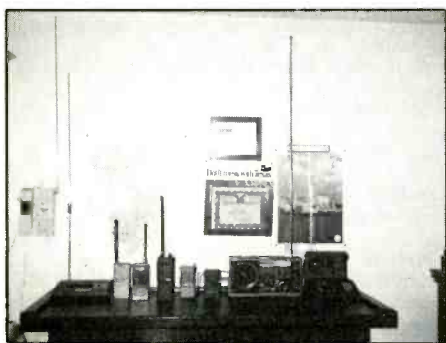

George Speck of Ft. Worth, Texas has been a scanner fan for several years and has just recently got into shortwave, too.

"What's with Radio Australia and the lack of QSL replies?" We still don't know, but a lot of folks are certainly noticing the change for the worse. Some have had some improved response by writing to the Frequency Division at the regular Radio Australia address. Gary K. Hamlin of Utica, New York who raised the point also comments on the "no-can-do" QSL letter he got from the BBC. Well, Gary, the BBC has maintained its unfortunate policy for decades now and we've about as much chance of seeing that change as we have of seeing a cookoo popping out of Big Ben every hour on the hour!

Tim Johnson in Galesburg, Illinois comments on an identified station he heard on 4940 at 0545. The program was just non stop rock for over an hour. Tim only heard the station on that one occasion and wonders if it might have been a pirate. Dunno, Tim, but you're not the only listener who spotted this.

If you live on the island of Hawaii there's a group of SWL's who'd like you to join them in their informal monthly meetings. If you'd like to meet fellow enthusiasts in the area, contact Larry Royston, P.O. Box 686, Pahoa, HI 96778 or give him a call at (808) 966-9297.

Phil Gilbert of Dallas had a go at trying for the 100 countries featured in the January POP'COMM. He didn't get them all, but he ended up with 101 anyway since he ran across some which weren't on the list. Good going, Phil!

Remember to send in your loggings each month—listed by country, with cutting space between each and your last name and state abbreviation after each item, please. We're also looking for shack photos and spare QSL cards (not returnable) as well as your comments, questions, station litera-

ture, news clippings and so on. Thanks for your continued support!

Here are this months loggings. All times are UTC and language English (EE) except where specified:

- Albania:** Radio Tirana, 2330 on 9760. (Perry, TX) 11825 at 0330 sign on. (Colter, TX)
- Antingua:** BBC relay, 5975 at 2238. (Moser, PA) Deutsche Welle relay, 6040 at 0128. (Gilbert, TX) 9545 at 0304. (Moser, PA) 11795/17810 at 2000 in GG. (Walbesser, NY)
- Argentina:** RAE, 6060//1170. Also 15345 in SS at 0100. (Bednarski, BC)
- Armenian SSR:** Radio Yerevan (via Radio Moscow, editor) 0353 with EE news on 7400. (Rudolph, AL) 0355. (Wright, MA) 0352 to sign off at 0358. (Carson, OK)
- Ascension Island:** BBC relay, 11750 at 2240. (Moser, PA) 15260 at 2055. (Gilbert, TX) 21660 at 1647. (Walbesser, NY)
- Australia:** Northern Territory Shortwave Service stations in Alice Springs on 2310 and Tennant Creek on 2325 heard in parallel with ID at 1000. (Wilczek, IL)
- Australia:** Radio Australia, 9580 at 1153. (Moser, PA) 9710 at 0838, 9655 at 0834, 15240 at 0630, 15320 at 0547. (Carson, OK) 11765 at 1158 in CC. (Foss, AK) 11795 at 0548. (Ross, WA) ABC - Perth, 15425 at 0805 with cricket match. (Johnson, IL) ABC - Brisbane, 4920 at 1200. QRM'd by Yakutsk, USSR. Also on 9660 at 0715. (Johnson, IL)
- Austria:** Radio Austria International, 6015 via Canada at 0630 in SS. (Bednarski, BC) 9870//9875 at 0135. (Johnson, IL) 13730 at 0130. (Ross, WA) 21490 at 1351 in SS. Into EE at 1355. (Wright, MA)
- Belgium:** BRT, 9925 at 0029 with IS ID and sign on. (Moser, PA) 17580 at 1630 to Africa. (Walbesser, NY) 21820 at 1344. (Wright, MA) RTBF, 15540 at 2108 in FF. (Walbesser, NY) 17675 at 0616 in FF. (Carson, OK)
- Benin:** ORTB Cotonou, 4870 at 0524 with talks in vernacular. (Gilbert, TX)
- Botswana:** Radio Botswana, 4830 at 0356 with IS and extreme QRM. (Moser, PA) Here and //7255 at 0415 with music and talk in vernacular. (Johnson, IL)
- Brazil:** Radiobras, 11745 in EE with news at 0208. (Ross, WA) Radio Globo, Rio, 11805 at 0900 in PP with talk, clear ID. (Wright, MA)
- Bulgaria:** Radio Sofia, 7115 at 0429. (Carson, OK)

9700 at 2250. (Gilbert, TX) 11680 at 0000. (Perry, TX) 15290 at 0327. (Colter, TX)

**Burkina Faso:** Radio Burkina, 4815 at 0615 in FF. (Moser, PA)

**Burma (Myanmar):** Defense Forces Broadcasting Unit, 6570, tentative at 1255 in unidentified language. Weak. (Johnson, IL)

**Cameroon:** Cameroon Radio & TV, Yaounde, 2158 in FF, ID and pops. (Wright, MA) 0458 with music, news, ID in FF and EE. (Gilbert, TX) 0540 in FF. (Johnson, IL)

**Canada:** BBC Sackville relay, 6175 at 2243. (Moser, PA)

CKZN, St. John's on 6160 at 0350 with EZL music, ID as "CBC Radio" and into news. (Mierzwinski, PA) CFRX, Toronto, 6070, relay CFRB-1010, at 0700. (Carson, OK)

RCI, 13670 at 2142 to Africa. (Walbesser, NY) 21545 at 1530. (Rudolph, AL)

**Chile:** Radio Nacional, 15140 in SS at 1701. (Moser, PA) 0045. (Perry, TX)

**China:** Voice of Jinling, 4875 at 1155 with opening music, ID in CC by man and woman. (Johnson, IL) CPBS, 5880 in CC at 1350. (Foss, AK)

Radio Beijing, 7350 in CC at 1254. (Foss, AK) 9770 at 0309. (Ross, WA) 11695 at 0420. (Neff, FL) 11855 at 1320. (Colter, TX) 17855 at 0339. (Gilbert, TX)

**Costa Rica:** Radio Impacto, 5044 and 6150 in SS at 0538. (Gilbert, TX) 5044 with SS ID 0159. (Johnson, IL)

Radio Reloj, 4832 at 0725 in SS. (Wright, MA) AWR Costa Rica, 9725 at 2252 sign on with ID and "Voice of Prophecy" program. (Neff, FL)

Radio For Peace International, 7376 USB at 0529 with "Earthwatch" program. (Gilbert, OK) 13660 with letters at 0306. (Ross, WA) 21565 at 2029. (Walbesser, NY)

**Colombia:** Caracol, Bogota, 5075 at 0535 and 9710 (new? editor) in SS. (Gilbert, TX)

Caracol Neiva, 4946 at 0745 in SS with pops, ID. (Wright, MA) 6150 at 0700 in SS. (Mierzwinski, PA) La Voz del Conaruco, 4885 in SS at 0545-0558 close. (Carson, OK)

**Cuba:** Radio Havana Cuba, 9710 at 0212. (Ross, WA) Here and 11760 at 0429. (Gilbert, TX) 11795 at 2000. (Rudolph, AL) 11800 at 2026. (Neff, FL) 11820 at 0000. (Zamora, ND)

**Cyprus:** BBC Relay, 7125 at 2155 with drama. (Johnson, IL) 21470 at 1431. (Wright, MA)

**Czechoslovakia:** Radio Prague, 5930 at 0143 with drama. (Gilbert, TX) 6055 at 2220. (Moser, PA) 5930/7345//9540//11990//13715 at 0100. (Walbesser, NY) 11990 at 0122. (Ross, WA) 21505 at 1547. (Carson, OK)

**Denmark:** Radio Denmark, (via Norway, editor) 21705 in Danish at 1640 but with EE ID. (Wright, MA) Here and parallel 25730 at 1430 in Danish. (Walbesser, NY)

**East Germany:** Radio Berlin International, 9730 at 2241. (Gilbert, TX) 11785 at 0248. (Ross, WA) 0407 on 11810. (Colter, TX) 15125 at 0444. (Carson, OK) 21465 at 1337 in unidentified language. (Wright, MA)

**Ecuador:** HCJB, 6230 at 0521. (Gilbert, TX) 9745 at 0540 and 11775 at 0530. (Carson, OK) 11795 at 0205. (Foss, AK) 15155 at 0200. (Neff, FL) 17890 at 1615. (Rudolph, AL)

**England:** BBC on 7325 at 0016, 9410 at 0310, 25750 at 1440. (Walbesser, NY) 9600 to Africa at 0430. (Schmidt, WI) 15070 at 0627. (Carson, OK)

**Egypt:** Radio Cairo, 9675 at 0224. (Moser, PA) 9900 in AA at 0148. (Ross, WA) 12050 at 1928 in AA. (Gilbert, TX)

**Finland:** Radio Finland International, 9645 at 0000. (Neff, FL) 11755 at 0737. (Gilbert, TX) 15400 at 1159, 1315, 1424. (Moser, PA, Colter, TX; Zamora, ND)

**France:** Radio France International, 9550 at 0413 in FF. (Gilbert, TX) 17620 in EE at 1605. 17795 with Medias France Intercontinents service in FF with sign on at 1512. RFI in FF at 1425 on 25820. (Walbesser, NY) 21580 at 1523 in FF. (Wright, MA) 21770 at 1402. (Moser, PA)

**French Guyana:** RFI relay, 9800 at 0305-0330 with news. (Perry, TX) Radio Japan relay, 9675 at 0832. (Moser, PA)

RFI - Cayenne, 5055 in FF at 0606, 0721. (Gilbert, TX; Johnson, IL)

**Gabon:** Africa Number One, 9580 in FF with pops at 2145. (Zamora, ND) 0558 with music, FF ID. (Moser, PA) 15475 at 1850 in FF. (Perry, TX)

Radio Japan relay, 11835 at 2116. (Walbesser, NY) **Ghana:** GBC-1, 4915 at 0600 plus with drums, ID, news, sports, music. (Gilbert, TX; Johnson, IL; Moser, PA)

**Greece:** VOA Relay, Kavala, 7205 at 0241. (Walbesser, NY) 21520 at 1411 in unidentified language to Asia. (Wright, MA)

Voice of Greece, 7430 at 0130. (Moser, PA) 9395 at 0154 in Greek. (Gilbert, TX) 9420 in GReek at 0255. (Ross, WA) 15630//17535 with news at 1537. (Walbesser, NY)

**Guam:** KTWR on 11650 at 1525 with ID, address. (Johnson, IL)

**Guatemala:** Radio Tezulutlan, Coban, 4837 (nominal 4835, editor) 0223 with music, ID in SS. (Gilbert, TX)

**Hawaii:** WWVH, 5000 at 0547 with time checks. (Gilbert, TX)

**Honduras:** Radio Luz y Vida, 3250 at 0320 with religious program in English. (Johnson, IL)

HRVC, La Voz Evangelica, 4820 at 0333 with religious programs in Spanish. (Gilbert, TX)

**Hong Kong:** BBC relay, 21715 at 0205. (Walbesser, NY)

**Hungary:** Radio Budapest, 9520 at 0044. (Walbesser, NY) 9835 at 0035 with news, ID. (Johnson, IL) Here and 11910 at 0035. (Moser, PA)

**India:** All India Radio, 9910 at 2155 with news. (Johnson, IL) 15110 at 1007. (Neff, FL) 15353 at 1424 with Indian music. (Moser, PA)

**Indonesia:** Radio Republik Indonesia, Ujung Pandang 4753 at 1242 with music in II. (Gilbert, TX)

**Iran:** VOIRI, 9022 at 1949 with political talk. (Moser, PA) 15084 at 1917 in Persian with ID. (Walbesser, NY)

**Iraq:** Radio Baghdad, 13680 at 1835 with music and discussion in AA. (Gilbert, TX) 15150//15400 at 2010 in AA. (Walbesser, NY)

**Voice of Israel / Kol Israel:** 9435 at 0015. (Perry, TX) 9930 at 0202. (Ross, WA) 11605 at 2245. (Rudolph, AL) 11605 at 2250, 17575 at 1624 (in AA) and 15640 in RR at 2122. (Walbesser, NY) 12080 at 0240. (Colter, TX) 21550 at 1511 in presumed Hebrew. (Wright, MA)

Reshet Bet home service, 15615 at 0125. (Colter, TX) Re

**Italy:** RAI, 9575 with news at 0100. (Gilbert, TX) 11905 at 0357. (Carson, OK) 17800 at 1400 in Italian. (Wright, MA) 21560 at 1828, sign on in Italian. (Walbesser, NY)

**Ivory Coast (Cote D'Ivoire):** RTV Ivoirienne, 7215 at 0608 with music and FF. (Gilbert, TX)

**Japan:** Radio Japan, 11835 (via Gabon) at 2358 with sign off. (Zamora, ND) 11840 at 1136. // Canada relay on 6120. (Moser, PA) 11865 at 1510. (Johnson, IL) 17810 at 0104. (Gilbert, TX) 17825 at 0302. (Ross, WA)

**Jordan:** Radio Jordan, 11955 at 0450 with music and news in AA. (Gilbert, TX) 13655 at 1410 in EE, ID at 1415 close. (Wright, MA)

**Kiribati:** Radio Kiribati, 14917.7 at 0620 with news, ID, music. (Johnson, IL) 14918 USB at 0608 with BBC news. (Gilbert, TX)

**Kuwait:** Radio Kuwait, 13610 at 2040. (Neff, FL) 15345 at 0504 in EE. (Carson, OK) 15495//15505 at 2100 in AA. (Walbesser, NY) 15505 at 2350 in AA. (Gilbert, TX) 21675 at 1624 in AA. (Wright, MA)

**Lesotho:** Radio Lesotho, 4800 at 0407 with discussion and music, in Sesotho. (Gilbert, TX) VOA relay, 6035 at 0614. (Gilbert, TX) 15445 at 2047. (Walbesser, NY) 1560 at 1640. (Perry, TX)

**Libya:** LJB/Radio Jamahiriyah, 15235 at 1849 in AA. (Gilbert, TX) Here and parallel 15415 at 2014 in AA. (Walbesser, NY)

**Lithuania:** Radio Vilnius, 7400 at 2302 with news. (Carson, OK) (Moscow has pulled the plug on Radio Vilnius--see the first part of this month's column. Editor)

**Luxembourg:** Radio Luxembourg, 6090 at 0033 with ID, rock. (Johnson, IL) 15350 at 2107 in FF. (Gilbert, TX)

**Madagascar:** Radio Netherlands relay, 15150 at 1429 with sign on, ID. (Moser, PA)

**Mali:** RTM, Bamako, 4835 at 2345 with songs. (Moser, PA) Presume FF. Editor) Radio Beijing relay, 9770 at 0302. (Moser, PA) 11715 at 0150 in CC. (Gilbert, TX)

**Malta:** Voice of the Mediterranean, 9765 at 0000 with ID. (Gilbert, TX) 061 in EE/AA. (Carson, OK)

Deutsche Welle relay, 6025//7235 at 0410 in AA. (Johnson, IL)

#### Abbreviation Used in Listening Post

|     |                                     |
|-----|-------------------------------------|
| AA  | Arabic                              |
| BC  | Broadcasting                        |
| CC  | Chinese                             |
| EE  | English                             |
| FF  | French                              |
| GG  | German                              |
| ID  | Identification                      |
| IS  | Interval Signal                     |
| JJ  | Japanese                            |
| mx  | Music                               |
| NA  | North America                       |
| nx  | News                                |
| OM  | Male                                |
| pgm | Program                             |
| PP  | Portuguese                          |
| RR  | Russian                             |
| rx  | Religion/ious                       |
| SA  | South America/n                     |
| SS  | Spanish                             |
| UTC | Coordinated Universal Time (ex-GMT) |
| v   | Frequency varies                    |
| w/  | With                                |
| WX  | Weather                             |
| YL  | Female                              |
| //  | Parallel frequencies                |

**Mauritania:** -RTVM, Nouakchott, 4845 at 0730, 0735 in FF. (Gilbert, TX; Johnson, IL)

**Mexico:** Radio Educacion 6185 in SS at 0321 with talk. (Gilbert, TX)

Radio UNAM (Radio Universidad) 9600 in SS at 1659-1720. (Perry, TX)

**Monaco:** Trans World Radio, 9480 at 0827 with the "Hour of Freedom." (Carson, OK)

**Mongolia:** Radio Ulanbaator, 12015 at 0910. Gave frequency schedule. (Johnson, IL)

**Morocco:** RT Marocaine, 15335 at 1902 in AA. (Gilbert, TX)

VOA relay, Tangier, 15205 at 1702. (Moser, PA)

**Mozambique:** Radio Mocambique, 4926.7 at 0520 in vernacular. (Johnson, IL) (Beware of Radio Nacional, Bata, Equatorial Guinea in this area at the same time. Editor)

**Namibia:** Radio Suid Wes Afrika, 3290 at 0315 with music, stock market at 0340. (Johnson, IL) (New name is Radio Namibia, editor)

**Netherlands:** Radio Netherlands, 6020 at 0118. (Gilbert, TX) 13770 at 1431 sign on. (Moser, PA) 17575 at 1215. (Neff, FL) 17605 at 1507. (Walbesser, NY) 21480 at 1346 in DD. (Wright, MA)

**Netherlands Antilles:** Radio Netherlands Bonaire relay, 9590 at 0330. (Rudolph, AL) 11715 at 2345. (Zamora, ND) 11720 at 0330. (Perry, TX) 15315 at 0230 in SS. (Bednarski, BC) 21685 in DD at 2040. (Walbesser, NY)

Trans World Radio, Bonaire, 9535 at 0315 with Caribbean Connection. (Ross, WA) 11815 at 1148. (Moser, PA) 0410 on 11930. (Carson, OK)

**New Zealand:** Radio New Zealand International, 17680 at 0326 with bellbird IS and 0330 sign on. Off 0610. (Carson, OK) At 0430 sign on in EE and Somoan. (Bednarski, BC) 17706 at 0445. (Schmidt, WI)

**Nicaragua:** Voice of Nicaragua, 6100 at 0850 in SS. (Wright, MA) 1137 in SS. (Gilbert, TX)

**Niger:** La Voix du Sahel, 0530 with sign on, chants, in FF. (Johnson, IL; Gilbert, TX)

**Nigeria:** Voice of Nigeria, 7255 at 0500 with drums, sign on, "Reflections," spiritual songs. news at 0530. (Colter, TX)

Radio Nigeria at Kaduna, 4770 at 0542 in EE, ads and disco. (Wright, MA)

**Northern Marianas:** KHBI, 9530 at 1154 with program end and "WCSN broadcasting from the Northern Marianas." (Moser, PA) (Christian Science station, ex-KYOI. Editor)

**North Korea:** Radio Pyongyang, 9977 at 1148 with announcements, ID, anthem, sign off. (Moser, PA) 1100-1149. (Foss, AK) 11735 at 2338. (Gilbert, TX)

**Norway:** Radio Norway, 11850 at 2200 with ID in NN. (Gilbert, TX) 17840 at 0403 with ID in EE/NN. (Colter, TX) Here and //25730 at 1420 in NN. (Walbesser, NY) 21710 at 1423 in EE. (Moser, PA) (Presume Sunday, editor)

**Oman:** Radio Oman, 17735 at 1912 with news in FF, sign off at 2014. Presumed 15545 varying. (Johnson, IL)

**Pakistan:** Radio Pakistan, 15533 at 1945 with news

in FF, sign off at 2014. Presumed 15545 varying. (Johnson, IL)

**Paraguay:** Radio Nacional, 9735 at 0020 with sports in SS. (Gilbert, TX)

**Peru:** Radio Nor Andina, Celendin, 4462 at 0900 in SS with cow and rooster sound effects, Peruvian music and talks. (Wilczek, IL)

Radio Union, Lima, 6117 at 0746 with music and slogan "la diferencia esta la Union." (Gilbert, TX)

**Philippines:** FEBC on 11650 at 2233 with CC religious program. (Gilbert, TX) 11850 at 1300 with Bible study. (Johnson, IL)

VOA Relay, 11715 at 1306. (Johnson, IL) 17745 at 1619 in CC. (Walbesser, NY)

**Poland:** Radio Polonia, 7270 at 2234 with news. (Moser, PA) (Polish?) 9565 at 0112 with news. (Gilbert, TX) (Polish?)

**Portugal:** RFE/RL via Portugal, 11725 at 0437 in RR. (Gilbert, TX)

Deutsche Welle Sines relay on 6085 at 0305 with news. (Moser, PA)

Radio Portugal, 9680 at 0242. (Moser, PA)

**Romania:** Radio Bucharest, 5990 at 0254-0305 with EE close and into SS. (Perry, TX) 9570 at 0159. (Carson, OK) 11940 at 0420. (Gilbert, TX)

**Rwanda:** Deutsche Welle relay, 7225 at 0401. (Moser, PA) 17860 at 2000 in GG. (Walbesser, NY) 2248 in GG. (Gilbert, TX)

**Saudi Arabia:** BSKSA, 9885 at 2136 in AA. (Moser, PA) 15060 at 0504 in Turkish. (Gilbert, TX) 21505 at 1405 in AA. 1640 in AA (Wright, MA; Walbesser, NY)

**Seychelles:** Far East Broadcasting Assn., tentative, 11810 at 1547 in possible AA. (Perry, TX)  
BBC relay, 15420 at 0308, 0510. (Gilbert, TX; Moser, PA)

**Sierra Leone:** SLBS on 3316 at 0557 with 5 note IS and music, in vernacular. (Gilbert, TX) 0617 with African music. (Moser, PA)

**Solomon Islands:** 9545 at 0705 with fruit prices, music and ID. EE and pidgin. (Gilbert, TX) 0715 with health program. (Johnson, IL)

**South Africa:** Radio RSA, 9580 at 0125. (Colter, TX) 9615 at 0246, 11930 at 0230, 25790 at 1518. (Carson, OK) 11935 at 0200. (Bednarski, BC) 15120 at 0200. (Rudolph, AL) 15230 at 1943. (Walbesser, NY) 21535 at 1415. (Wright, MA)

Radio Five, 4880 with pops 0350. (Perry, TX) 0418 with ID, commercials, hi-life music. (Wright, MA) //11885 at 0614. (Carson, OK)

**Spain:** Spanish National Radio, 9360 in SS at 0035, 15110 in SS at 1930 sign on; 17840 at 0112. (Walbesser, NY) 9630 at 0005. (Zamora, ND) 11880 at 0124. (Ross, WA) 15525 at 0200 and 17890 in SS at 1700. (Bednarski, BC) 21555 in SS at 1514. (Wright, MA)

**South Korea:** 9750//15575 at 1442. (Carson, OK) 15575 at 0250. (Gilbert, TX)

**Sri Lanka:** SLBC, 15425 at 1722 with music and announcements to sign off. (Moser, PA)

VOA Relay, 11705 at 0143. (Gilbert, TX)

**Swaziland:** Trans World Radio, 11740 at 0612 with news. (Gilbert, TX)

**Sweden:** Radio Sweden, 11705 at 0244 with news. (Ross, WA) 15190 at 1250. (Foss, AK) 21610 at 1530 with mailbag. (Wright, MA)

**Switzerland:** Swiss Radio International, 6135//9725//9885 at 0228. (Moser, PA) 9885 at 0400. (Schmidt, WI) 12035 at 0406. (Carson, OK) 15525 at 2100. (Walbesser, NY) 17730 at 0113, into SS at 0230. (Olson, ND) 21630 at 1613 in FF. (Wright, MA)

**Syria:** Radio Damasas, 12095 at 2112 with ID, music. (Johnson, IL) 15095 at 2126 with comment, music. (Moser, PA)

**Tahiti:** Radio Tahiti, 11825 with island music and FF at 0757. (Gilbert, TX) 15170-15171 at 0450 in TT. (Johnson, IL) 0824 in FF. (Moser, PA)

**Taiwan:** Voice of Free China (via WYFR) on 11745 with sign on in JJ at 1356. (Perry, TX) 11805 at 2200. (Walbesser, NY) 15215 at 0200 in SS. (Bednarski, BC) 15345 (direct) at 0535 in CC. (Ross, WA)

**Thailand:** Radio Thailand, 9655 at 1215 with music and woman in unidentified language. (Gilbert, TX)

**Togo:** RTT Lome, 5047 at 0630 with man in FF. (Gilbert, TX)

**Tunisia:** RT Tunisienne, 11550 at 0747 in AA. (Gilbert, TX)

**Turkey:** Voice of Turkey, 0357 with IS, ID, sign on. (Moser, PA) 0440. (Colter, TX) 15267 at 0750, down

from 15270. (Johnson, IL)

**Ukraine SSR:** Radio Kiev, 7400 at 0300 with news. (Rudolph, AL) 15180 at 0304. (Ross, WA)

**United Arab Emirates:** Voice of the UAE, Abu Dhabi, 9600 at 2350 with "The Truth About Islam." (Johnson, IL) 11985 at 2206 with Korean readings. (Gilbert, TX) 21515 at 1408. (Wright, MA)

UAE Radio, Dubai, 11940 at 0353 and into sign off. 17890 at 0339 to 0354 closing. (Carson, OK) 13605 at 2216 with Islamic history. (Moser, PA) 21605 at 1528 in AA. (Wright, MA)

**United States:** Voz de la OEA (Organization of American States), in SS at 0000 on 9565//11830//15160. (Bednarski, BC)

Radio Marti, 9525 in SS 0200. (Bednarski, BC) 11930 at 1602. (Wright, MA)

KUSW on 15590 at 1905 with phone-in music program. (Neff, FL)

WINB, 15185 at 2047 with "Shortwave Radio Church" at 2047. (Carson, OK) 15295 at 1825. (Neff, FL)

WMLK, 9465 at 0430 with Sacred Name Broadcaster magazine. (Carson, OK)

WHRI, 9495 at 0025. (Neff, FL)

WWCR, 7520 at 0215. (Rudolph, AL) 15690 at 1830. (Neff, FL)

KVOH, 17775 at 2115 in SS. (Olson, ND)

**USSR:** Radio Moscow, 5960 at 1315. (Foss, AK) 5905 at 0557, 7270//73456 at 0745, 15455 at 0648, 17690 at 0400, 17890 at 0335. (Carson, OK) 9530 at 0053, 15460//15475 at 1803, 17660//17810 at 1520 and 17825 at 0110. (Walbesser, NY) 11950 at 2230. (Moser, PA) 17700 at 0310. (Olson, ND) 21690 at 0052. (Perry, TX)

Yakutsk Radio, 4920//4940 at 1200 in RR. 4920 QRM'd by Australia. (Johnson, IL)

Radio Peace and Progress, 0026 in SS on 11700. (Moser, PA)

Azerbaijani Radio, Baku, 4958 at 0400-0500 in Azerbaijani. (Mierzwinski, PA)

**Uzbek SSR:** Radio Tashkent, 11785//15470 at 1345 with news, ID. (Johnson, IL)

**Vatican:** Vatican Radio, 6185 at 0600 with ID in FF/EE. (Gilbert, TX) 6190 in EE at 2103, 17730 in African language at 1513. (Walbesser, NY) 9605 at 0049 sign on. (Moser, PA) 9615 at 2145 in JJ, into EE at 2205. (Zamora, ND) 11725 at 0310. (Ross, WA) 21485 at 1348 in SS. (Wright, MA)

A tip of the hat to the following reporters this month:

Frank Mierzwinski, Mt. Penn, PA; Mike Perry, Corpus Christi, TX; David Olson, Wafford City, ND; Phil Gilbert, Dallas, TX; William Rudolph, Birmingham, AL; Jim Ross, N7MYW, Vancouver, WA; Joe Wright, Jamaica Plain, MA; Russell Schmidt, Wauwatosha, WI; William Walbesser, Revena, NY; A.E. Bednarski, N. Vancouver, BC; Donna Colter, Houston, TX; Marty Foss, AL7JF, Anchorage, AK; Tim Johnson, Galesburg, IL; John Spencer Carson, Jr., Norman, OK; William Moser, New Cumberland, PA; George Neff, Tampa, FL; Larry R. Zamora, Grand Forks, ND and William Wilczek, Lockport, IL.

'Til next month—good listening!

PC

### High Performance 800MHZ



- Enjoy the best possible reception
- Hear signals other antennas miss
- Astounding performance outside
- Hear 10 times more signals when mounted directly on scanner

Only **\$19.95** Free shipping (cont. USA)  
• Money back guarantee

## MAX System™

GROUND PLANE ANTENNAS  
CK-MO-MC-VISA Accepted (MA add 5% sales tax)

Send payment to: Cellular Security Group,  
4 Gerring Rd. Gloucester, MA 01930  
Or charge by phone: (508) 281-8892

### MetroWest announces . . .

Double Time for your Bearcat 100 XLT  
and 200 XLT Scanners

Run TWICE as long between charges with the New MetroWest Pro Pack 1200!

- 1200 ma-hr pack has Double the capacity of the original Bearcat pack.
- Perfect fit, style and color match to scanner. Only 0.2" Thicker than BC Pack. Fits into factory case.
- Recharges with your Bearcat module
- Guaranteed to double your run time
- 30 day trial and 1 Year performance guarantee
- Fully USA Made

**MetroWest** Only **\$59**  
822 N. Spring (plus \$4 S&H)  
LaGrange Park, IL 60525  
(708) 354-2124  
Mastercard and VISA accepted

CIRCLE 53 ON READER SERVICE CARD

### Add New Enjoyment To Your SW Receiver with the Portable MICRODEC™ Decoder



MODE PUSH BUTTON Selects CW, RTTY, ASCII

ALPHANUMERIC 5X7 DOT, 8 SEGMENT LED DISPLAY

SIGNAL STRENGTH INDICATOR LED

POWER/VOLUME CONTROL

MODE

UP DOWN

DISPLAY INTENSITY CONTROLS

SEVEN LEVELS OF INTENSITY

**\$199**

MICRODEC™ converts MORSE, RTTY, and ASCII to ALPHANUMERIC CHARACTERS

- Automatically tracks MORSE code speeds from 5 to 70 WPM
- Decodes 60, 67, 75, 100 WPM RTTY and 110, 330 BAUD ASCII.
- Standard ASCII port to interface with your computer.
- Internal practice code oscillator.
- Standard cockpit green display. (red & yellow optional)
- Power switch/Volume control/Internal speaker
- Completely portable with optional NICAD rechargeable batteries mounted internally. — \$29.95
- Ultra compact and lightweight
- 1.5 H x 5.08 W x 5.25 L (1 pound w/batteries).
- Operates on DC voltages between 9 VDC and 15 VDC (9 VDC adapter provided at no cost).

SHIPPING AND HANDLING: Continental United States add \$8.50 for UPS ground. Florida residents add 6% sales tax. Other types of Express shipments and foreign destinations will be quoted on request.

METHODS OF PAYMENT: MasterCard, VISA, Money Orders, Certified Checks, and Personal Checks. Please note for personal checks we allow two weeks for checks to clear.

## SOMERSET ELECTRONICS, INC.

1290 HIGHWAY A1A, SATELLITE BEACH, FL 32937 • ORDER & FAX: (407) 773-8097

CIRCLE 54 ON READER SERVICE CARD

### 2-30 MHz Custom Whip

Arriving at a disaster scene may require quick mobility to get an antenna up on high frequency requirements. Well, almost practical, providing the frequencies are within the pre-determined band limits your mobile whip is tuned to.

For ham radio high frequency, the following bands offer good communications advantages.

Not all disaster communications are necessarily conducted on ham radio frequencies. The following bands have carried a substantial amount of emergency communications from the American Red Cross, Federal Emergency Management Association (FEMA), MARS, Coast Guard, Civil Air Patrol, and the National Guard:

- 2000 kHz - 2790 kHz
- 6 MHz
- 8 MHz
- 12 MHz
- 16 MHz
- 22 MHz

Your best source for determining which emergency agency may transmit on what frequencies is available from Grove Enterprises (Brasstown, North Carolina;), with valuable frequency data found in their thick Federal frequency book.

As an emergency communicator, lightweight, fiberglass whips are a reasonable, efficient, and quick way to come up on a

75 meters—3.8-4.0 MHz

40 meters—7.0-7.3 MHz

20 meters—14-14.350 MHz

15 meters—21-21.450 MHz

10 meters—28-29.7 MHz

Nighttime statewide coverage

Daytime statewide coverage, 1500 miles nighttime coverage

Day and night long-range coverage, coast to coast

Daytime worldwide coverage

Daytime strong skywave coverage

ham band from your solid-state output transceiver. However, most manufacturers of amateur radio antennas may not regularly stock special-order frequency whips. Or, if they do, these whips might cost twice as much as regular ham whips. (Mobile Mark, Ohio.)

Just recently, Don Arnold, WD4FSY, well-known worldwide photographer and ham radio enthusiast, made a connection to bring in a very strange-looking antenna for mobile, all-band use, the "OUTBACKER." This very strange-looking antenna has over 20 years of history in Australia and the Northern Territories as the most reliable multi-band whip for staying in touch on the many Australian emergency land channels. Because of the remoteness of Australia, their high frequency mobile radio service regularly depends on a sturdy H.F. whip.

Several different types of Outbacker

whips are available—but the one that makes most sense for emergency communicators is the 15-band, 7-foot tall, helical multi-tap whip capable of operating on the following bands:

- 2 MHz emergency
- 3.8 MHz ham (75 meters)
- 4.1 MHz emergency
- 6 MHz emergency
- 7 MHz ham (40 meters)
- 8 MHz emergency
- 12 MHz emergency
- 14 MHz ham (20 meters)
- 16 MHz emergency
- 21 MHz ham (15 meters)
- 22 MHz emergency
- 28 MHz ham (10 meters)

The 7-foot whip comes in 2 varieties—one big long whip, or a 7-footer that breaks

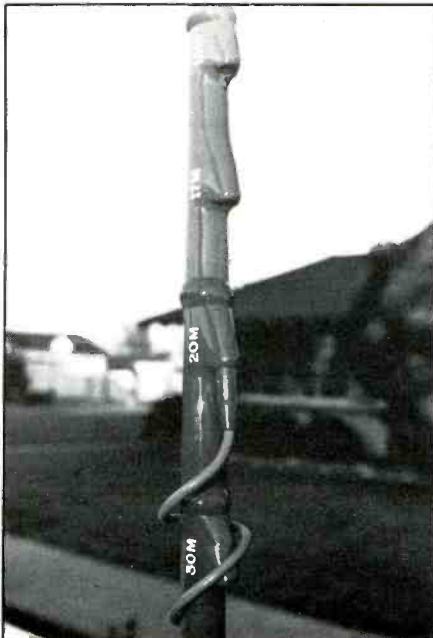

Close-up of wonder wire plug connection point at 20 meters.



Don Arnold, WDL1FSY, taps into the 30 meter band.

into 2 sections. I prefer the 2-section whip because of portability.

The whip is characterized by hand-wound, helical-wraps around a sturdy fiberglass rod, covered with a thick coating of polyurethane epoxy. Traveling up the shaft are a series of marked MHz nodules that accept a banana-plug jumper.

The jumper wire emanates from the base, and wraps around the outside polyurethane epoxy in a counter-clockwise spiral. The manufacturers call this outside wire the "wonder wire" for matching to any band of your choice. I consider it the ugly wire, because it makes the whip look all that much more strange with something on the outside, wrapped around it. Nonetheless, it works. And it works well!

The whip operates on the principal of helical-loaded, quarter-wave resonator. You tap into the resonant portion of each band by plugging in the wonder wire's banana plug to the appropriate nodule. For the lower bands, you tap in relatively low—which requires winding more of the wire around the bottom of the antenna. For the higher frequencies, such as the 15 and 10 meter bands, the wonder wire only makes a couple of revolutions around the antenna in order to have just enough length to plug it in at the top. Keep the wire winding tight, and the VSWR is extremely low.

The best part of the antenna for emergency communicators is the number of pre-set

bands that you might tap into. There may be as many as 15 different options on their most popular marine and emergency mobile communications whip. This is the one I tested, and the resonance was right on the nose for each ITU international band that encompassed emergency frequency allocation. I found that the built-in automatic tuner on the Kenwood 440 would easily compensate for any elevated VSWR if I needed to operate several hundred kHz away from pre-determined bands on the whip.

The overall performance of the whip matched the performance of a similar-size, single-band whip, to our surprise. I expected some degradation on the lower frequencies, but was surprised with the performance. So judging the whip for skywave communications, it does just as well as a regular 6 or 7-foot ham whip on ham frequencies. And on emergency channels, the whip excelled because it's tough to find any type of quarter-wave whip that works on "special order" frequencies.

The base is unusual. A massive spring is included that contains a regular SO-239 coaxial cable connector. The whip screws into the spring using 1/2-inch Australian threads. I have been assured that the amateur radio version comes with the more common 3/8-inch x 24 threads—but for the emergency antenna with more weight, you do need to go with the big, heavy spring.

Mounting the spring is not difficult if you

have the right type of bracket. I found that it mounts nicely on mobile mounts that feature a hole to normally accommodate a coax plug and 3/8 inch x 24 thread receptor. That's a common mount found on chain bumper mounts. Angle brackets are available from Valor (Ohio) that can easily accommodate the massive spring assembly when you remove the unused Valor hardware that goes in the hole on the horizontal side of the bracket. The antenna needs a good ground plane to act as a counterpoise, so mount your bracket up high on your emergency communications vehicle. Mounting any antenna along side the metal frame of the vehicle dramatically reduces its output, and increases VSWR.

Yes, the antenna is expensive at about \$380 for the complete affair, including the heavy-duty spring, but it's the only one around that offers a single whip that may be easily field-adjusted (with the wonder wire tap) for any band operation.

For more details, contact Outbacker Antenna Sales, 330 Cedarglen Circle, Chattanooga, Tennessee 37412; 1/800/2HF-WHIP.

And if you ever want to hear one live, tune in to 28.333 any Tuesday evening at 0200 hours (Wednesday morning, UTC) and listen to my Tuesday evening 10-meter broadcasts. This whip works well for emergency communicators constantly needing to hop around on many bands mobile. **PC**

## More QSO's

when you speak their language.



- Add extra spice to your DX QSO's
- Let your DX friends know you care enough about them to learn their language. (After all, they've gone out of their way to learn English!)
- Break the phone pile-up with a few carefully chosen words in the DX station's own language. You'll be amazed at the difference. It's like adding 3 dB to your signal.

**The Radio Amateur's Conversation Guide** by OH1BR and OH3BAD gives you the 147 most often used phrases in eight languages: English, German, French, Italian, Spanish, Portuguese, Cyrillic Russian, Phonetic Russian, Phonetic Japanese. Phonetic alphabets and eight-language dictionary included in this rugged spiral-bound manual a MUST for any serious DXer or Contestor. Beat the competition. Order yours today. Only \$10.00 plus \$2.00 per order shipping.

**Supplements** available in less-used languages: Dutch/Flemish, Danish, Finnish, Swedish, Serbocratian. \$4.00 per supplement. Be sure to state which language supplement you need.

### New cassette tapes in eight languages

Now you can hear the exact pronunciation of the sentences, phrases and words covered in *The Radio Amateur's Conversation Guide*. Each high quality language tape is recorded with proper dialect and usage in one of the languages in the Conversation Guide.

**CQ Book Shop**  
76 North Broadway Hicksville, NY 11801

Please send the following

Conversation Guide Book \$10

Language Tapes \$10 each

German

French

Spanish

Finnish

Portuguese

Russian

Japanese

Swedish

Supplements \$4 each

Dutch/Flemish

Danish

Finnish

Serbocratian

Swedish

Add \$2 for postage and handling in North America **Total**

Name \_\_\_\_\_

Address \_\_\_\_\_

City \_\_\_\_\_ State \_\_\_\_\_ Zip \_\_\_\_\_

Check  Money Order  MasterCard  VISA  Amex

Card No. \_\_\_\_\_ Expires \_\_\_\_\_

# SCANNING VHF/UHF

BY CHUCK GYSI, N2DUP

## MONITORING THE 30 TO 900 MHz "ACTION" BANDS

**K**ee an ear on those scanners! The summer action is hot, no matter where you are. And if you find any interesting frequencies on those hot and long summer nights, don't forget to let your friends here at POP'COMM know about them.

John Lyman of Tacoma, Washington, reports that the Morning Club has confirmed the use of 154.570 MHz by McDonald's drive-through windows in Tacoma. Generally, at least one side of the conversations at McDonald's order windows can be found on either 154.570 or 154.600. It's very aggravating for those who need those frequencies for radio communications because of the constant carrier, and in some areas, McDonald's stores have switched frequencies to avoid problems. Some fast-food joints, such as the Hardee's in my area, have taken a more practical approach and set up shop on 12.5 kHz splinter low-power channels on the UHF band. There's less potential for interference there.

From Monticello, Georgia, B.J. Hirsch checks in with a listening tip. B.J. says that he likes to keep his handheld scanner with him while traveling around town. However, the low audio output makes it less than desirable for listening purposes. He says that he headed down to the local Radio Shack and picked up a CD-to-cassette adapter (part No. 12-1951), which has a 1/8-inch stereo plug. He then also purchased an adapter to convert the 1/8-inch stereo plug to a 3/32-inch mono jack (part No 274-381). He says that it took less than five minutes to plug everything together and slip the "cassette" into the car stereo. Now he says that he has all the volume that he needs, plus the option of adjusting bass and treble, balance and fader. Not a bad mobile idea!

Joseph A. Banks of Rockaway Beach, N.Y., is planning on buying an ICOM R1 handheld and says his primary listening interests are cordless and cellular telephone calls. He was wondering what would be the best antenna for his handheld. First of all, I'd see how well the antenna supplied with the unit works. Because I am writing this before the R1 is released to the public, I haven't had my hands on one yet. The cordless phones operate on the 46 and 49 MHz range. The best antenna for any given band is an antenna that is cut and designed to function exclusively on that band. For instance, when the state police switched to 800 MHz where I had been living, my handheld reception was somewhat marginal at best. I then purchased a professional two-way handheld 800 MHz antenna and my 800 MHz reception improved significantly over the supplied rubber duck for the scanner.



*Here's the impressive shack of Andrew Dinallo, N2HUH, of Brooklyn, New York. Some receivers included among Andrew's gear are an Icom R7000, Realistic PRO-2004 and PRO-34 and Uniden Bearcat 205XLT.*

Likewise, if cordless listening is your bag, you might want to try getting your hands on a professional two-way rubber duck designed to operate on VHF low band, specifically the 42-50 MHz portion. You'll have to switch your ducks as you switch listening to different bands, but your reception will be significantly better. Give it a try.

Roger West of Amery, Wisconsin, sends in an interesting list of air show frequencies for the Navy's Blue Angels, Air Force's Thunderbirds and the Army's Golden Knights. Blue Angels: 121.900, ground support; 142.000, air to air tactical primary; 142.025, ground support repeater output; 142.625, ground support repeater input; 143.000, air to air; 143.600, maintenance; 241.400, air to air; 250.800, air to air; 251.600, air to air (aircraft 5-6) and air to ground; 360.400, air to air; 384.400, air to air; 391.900, air to air; 395.900, air to air; 123.400, common control; 142.265, unknown use. Thunderbirds: 120.450, operations; 140.400, air to air tactical; 141.850, air to air tactical primary; 236.550, air to air (solo 5-6); 236.600, air to air; 241.400, air to air; 250.850, team leader; 273.500, air to air; 283.500, air to air; 294.700, air to air; 322.300, air to air; 322.600, air to air; 382.900, air to air; 394.000, air to air;

413.025, ground support (low power); 114.950, unknown use; 124.930, unknown use; 140.000, unknown use. Golden Knights: 42.35, operations primary; 32.20, operations secondary; 123.400, common control. In addition, Roger suggest programming in these frequencies several days before a scheduled air show because the teams set up and do several practice runs using their radios. Thanks for the great list of frequencies.

William R. Young of Merrillville, Indiana, sends in some tips on using the GRE Super Converter II on both the Realistic PRO-33 and PRO-34 handheld scanners. For starters, Bill says that instead of installing a 9-volt battery in the 800 MHz converter, he made up a small plastic box containing six AAA cells in series. A 6-inch piece of speaker wire and a connector on the converter. He says that this is more convenient than changing a 9-volt battery in the converter and lasts longer, too. Bill claims that by using good quality AAA cells, he can get 60 hours of operation of the 800 MHz converter. Bill also reports that there is a modification that can be made to the standard rubber duck antenna supplied with the PRO-33 or PRO-34 that greatly improves operation at 800 MHz. About two-thirds of the way up from the connector end, there is a brass piece inside the antenna that can be felt by flexing the antenna. Bill says to cut off the antenna just above the brass piece and seal the cutoff end with tape or plastic (Bill used an end cap from a roll of RG-8 coax). The antenna now works better at 800 and 900 MHz, Bill claims, and works adequately on VHF high band, but isn't so hot on VHF low band. For VHF, Bill uses a Scantenna from CRB Research. Bill also passes along a listening tip for those with unmodified scanners who wish to listen to cellular. Take the scanner's IF (intermediate frequency, which can be found in the owner's manual) and double it. For instance, it's 10.7 MHz for most Regency and Radio Shack scanners and 10.8 MHz for most Uniden Bearcat scanners. Double this (21.4 or 21.6 MHz) and just enter frequencies 21.4 or 21.6 MHz lower than the cellular base frequencies you want to check out. Bill claims he can here about 80 percent of the cellular stuff in northwest Indiana using this trick and that it works almost as well as using the GRE Super Converter II. Thanks for the great listening tips, Bill.

Chris Anders of Midwest City, Oklahoma, sends in some interesting military frequencies: Local and surrounding state air refueling operations, 235.100, 293.000, 305.500, 352.700, 289.700, 276.500, 238.900, 327.600, 26.0.200; 28 Air Divi-



sion Command Post (Raymond 24), 381.300, 305.600, 141.650, 139.950; Tinker Metro (Tinker Air Force Base meteorology office), 344.600 (this provides weather to any airborne military aircraft for whatever area the pilot requests. Also heard are PIREPS, or pilot reports, of weather and flying conditions from the pilot himself); 552 AWACW flight line aircraft maintenance, 407.375 (f-1, aircraft maintenance), 407.550 (f-2, aircraft maintenance), 408.050 (F-3), 408.175 (F-4), 408.800 (f-5, exercises); Mole Control, 382.600 (This frequency is used by test pilots when they fly aircraft that have been received out of depot-level maintenance. It can prove interesting when problems come up on board the aircraft.); Tinker Air Force Base fire and crash, 163.5875, 164.125; Tinker Air Force Base enforcement and security police, 163.4875, 164.175. Chris also passes along frequencies used by the National Severe Storms Laboratory (173.100, 163.275, 409.750) for vans sent to the path of a tornado. These TOTO (Totable Tornado Observatory) units can create interesting listening.

If you have a question, or would like to share some interesting frequencies you found or photos of your listening post or an antenna farm nearby, write to: Chuck Gysi, N2DUP, Scanning VHF-UHF, Popular Communications, 76 North Broadway, Hicksville, New York 11801-2909.

PC

### ENGINEER'S TRADE SECRETS OF RADIO

by J.R. Cunningham

- How to build AM broadcast transmitters
- Info on AM broadcast antennas
- Homemade mica RF capacitors
- Winding your own coils
- AM modulation techniques
- Handbook for the broadcast engineer, ham, citizen's band operator, etc.

**\$29.95 Postpaid**  
C.O.D. Orders Accepted

Medicine Man CB  
P.O. Box 37  
Clarksville, AR 72830  
(501) 754-2076



CIRCLE 70 ON READER SERVICE CARD

Hundreds of Ham Radio Nets listed in the World Ham Net Directory \$9.95 plus \$1.25 (\$2 foreign) US Funds

Tiare Publications  
P.O. Box 493  
Lake Geneva WI 53147

### NextDay Reception Reports

Two-Color Printing  
Rainbow Cardstock  
100 200 300  
\$19.95 \$24.95 \$29.95

- Specify • Receiver  
• Antenna  
• Your 40-Word Personal Message



• Command Attention • Send Clear Reports • Speed Replies • Save Time •

Box 50062-P • Provo, UT 84605 • AntennasWest  
Circle 68  
Hotline 800-926-7373

CIRCLE 6 ON READER SERVICE CARD

THE MONITORING MAGAZINE

## They're Here!

# MODERN ELECTRONICS

## FUN PROJECT BOOKS

Order both books and pay only \$22.95 plus shipping.

You'll want these two exciting project books, packed with complete plans for building a wide variety of useful electronic devices. The *First and Second Books of Modern Electronics Fun Projects*, both Howard W. Sams publications, are now available.

You'll find all the how-it-works information, schematics, photos, drawings, printed-circuit guides and the parts sources to make it a snap to build almost 50 useful, unique electronic devices at modest cost.

Discover how these circuits and modern electronic devices perform their magic. Learn practical electronic technology the painless way and enjoy doing it!

All projects are based on material published in *Modern Electronics*, with updates and revisions. They've been built and tested by the original authors. Chapters are divided into; Intro To Electronic Projects, Home Electronics, Audio/Video Electronics, Security Electronics, Computers, Test Equipment, and Electronic Designing. There's something for everyone!

Look at what you can build and take pride in:

- \* Digital voltmeter accessories—high-frequency ac probe, true-rms adapter, temperature probe
- \* Car projects—anti-theft alarms, engine tachometer
- \* Life-saving detectors—gases & microwave leaks

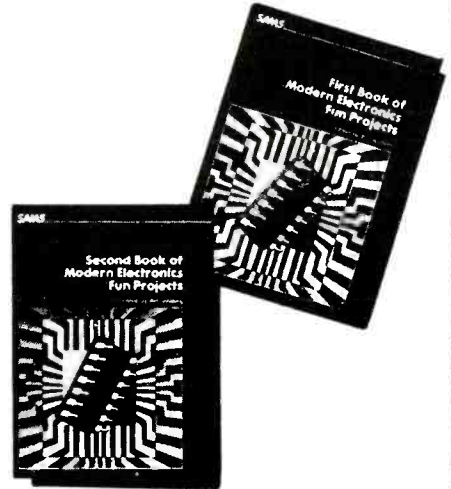

- \* Computer system power controller
- \* Dual-pulse generator
- \* Surround-sound audio enhancer
- \* Security—telephoned status reporter, alarm control center
- \* Home convenience—selectable phone ringer musical tunes, touch-sensitive light controller. ... and so much more.

The Fun Projects are capped by introductory information on building projects and kits (tools needed, parts sources, etc.) and advanced design techniques that illustrate how a designer thinks and plans when putting together a practical end product.

From beginning to end, MODERN ELECTRONICS FUN PROJECT BOOKS are for you! Order them today for a fast start in the world of electronics.

### MODERN ELECTRONICS

76 N. Broadway, Hicksville, NY 11801

Name \_\_\_\_\_

Address \_\_\_\_\_

City \_\_\_\_\_

State \_\_\_\_\_ Zip \_\_\_\_\_

( ) Check ( ) MasterCard ( ) VISA

Card No. \_\_\_\_\_

Expires \_\_\_\_\_

Signature \_\_\_\_\_

(Signature required on all charge orders)

Order Date: \_\_\_\_\_

| QTY | Title  | Price          | Total |
|-----|--|----------------|-------|
|     | First Book of Modern Electronics Fun Projects  | \$12.95 ea.    |       |
|     | Second Book of Modern Electronics Fun Projects | \$12.95 ea.    |       |
|     | <b>Both Books</b>                              | <b>\$22.95</b> |       |
|     |  | *Shipping      |       |
|     |  | <b>Total</b>   |       |

Order both books and pay only \$22.95 plus shipping.

\*Shipping charges \$2 per order. Orders processed day received, but please allow 30 days for delivery.

# BROADCAST DX'ING

BY ROGER STERCKX, KVT1JH

DX, NEWS AND VIEWS OF AM AND FM BROADCASTING

**Shifting Format Problem.** Sometimes, when one station changes its program format, vibrations go out that affect other stations. As James Kline, of Santa Monica, CA let us know, that's what happened when KKGO-FM (105.1 MHz) dropped its long-standing jazz format and went to a classical music format. The jazz programming was picked up by KKGO-FM's AM outlet, KKJZ (ex-KKGO) on 540 kHz, 25/3 kW from Hesperia. The jazz audience dutifully switched from FM to AM, and the general reaction was not all that good.

Besides the substantial reduction in audio fidelity when AM is compared to FM, listeners immediately began complaining that the signal coverage of the AM outlet was not as good as the FM was and some jazz fans were distinctly unhappy about what they were able to hear in the way of Charlie Parker and Miles Davis, especially after sunset. To be sure, not every listener expressed unhappiness, but a sufficient amount of grumbling was noted to be recorded in the local press. The station acknowledged the problems and said they were trying to do what they could to improve the situation. The station noted that the jazz programming is still available on FM, via a subcarrier on KKGO. Listeners can purchase (from KKGO at cost, which is \$150) an adapter to receive the jazz subcarrier in stereo, but probably at a fidelity range less than regular FM.

**Noise Free AM Radio?** Tim Coucke, KE4KE, of Anchor Point, AK passed along some interesting information on a "noise free AM radio" technique that utilizes frequency modulation technology within the AM broadcasting band. The concept was developed by retired engineer George Yazell, and at press time, station WQYK (1010 kHz, 50 kW) in Tampa, FL was seeking FCC authority to run on-the-air tests of noise free radio (NFR).

From the literature we have seen on this system, it seems to be a viable approach and holds lots of promise. The developer of this



This "Power 106 FM" bumper sticker is from Los Angeles station KPWR-FM, 105.9 MHz. It was sent in by Kelly Starkey, West Hills, CA.

system can be contacted at: Mr. George W. Yazell, PE, P.O. Box 8086, Lakeland, FL 33802. Forward-looking stations might wish to check in with Mr. Yazell regarding the status and progress of his development. It's really very clever.

In the meantime, if you recently noticed any improvement in the general sound of things on the AM band, it may be because of the FCC's new NRSC-2 emission standard, which became effective this June 30th. This specifies the maximum RF emissions radiated from the transmitter. It is intended to be used in conjunction with NRSC-1 audio standard, which relates to the way audio is processed before entering the transmitter. Used together, the standards are supposed to improve AM fidelity by reducing adjacent channel interference levels and employing pre-emphasis of upper mid-range audio frequencies. The standards will require stations to limit both their transmitter audio and the amount of audio pre-emphasis they employ.

**FM Translators.** First authorized 20 years ago, FM translators are stations that receive the signals of FM broadcast stations and simulcast them on another frequency. Translators are used to provide FM service to areas and populations that would otherwise be unable to receive satisfactory FM signals due to distance or intervening signal ob-

## New FM Call Letters Assigned

|      |                     |
|------|---------------------|
| KBEY | Garberville, CA     |
| KJTX | Jefferson, TX       |
| KOSY | La Monte, MO        |
| KRLF | Pullman, WA         |
| KWNJ | Reno, NV            |
| KWNL | Downs, KS           |
| KWOJ | Locust Grove, OK    |
| WGLZ | West Liberty, WV    |
| WNJ  | Rockford, IL        |
| WNZN | Lorain, OH          |
| WRFH | Marietta, PA        |
| WSUY | Charleston, SC      |
| WXPZ | Milford, DE         |
| WXVU | Villanova, PA       |
| WXZX | Winifield, AL       |
| WYBA | Lewisburg, PA       |
| WYBD | Rural Retreat, VA   |
| WYBF | Radnor Twp., PA     |
| WYBH | McConnellsville, OH |
| WYBJ | Greenville, MS      |

## New AM Call Letters Assigned

|      |                |
|------|----------------|
| KAVR | Rosamond, CA   |
| KEVT | Cortaro, AZ    |
| WGZS | Dothan, AL     |
| WRUB | Pittsville, MD |

## New Shortwave Callsign Assigned

|      |              |
|------|--------------|
| KWHR | Honolulu, HI |
|------|--------------|



The "Rock 107 Power Hits" bumper sticker represents WRCK-FM, 107.3 MHz, Utica, NY. It was submitted by Gary Hamlin.

## Changed FM Call Letters

| New     | Former  |                       |
|---------|---------|-----------------------|
| KNER    | KDAB    | Ogden, UT             |
| KDAP-FM | KOUD    | Douglas, AZ           |
| KDON    | KDON-FM | Salinas, CA           |
| KECR-FM | KECR    | El Cajon, CA          |
| KEYR    | KRXX    | Marlin, TX            |
| KGLR    | KBQC-FM | Bettendorf, IA        |
| KINF-FM | KINF    | Dodge City, KS        |
| KISQ    | KJKC    | Portland, TX          |
| KJJO-FM | KKJO    | St. Louis, MN         |
| KMBQ    | KNBZ    | Wasilla, AK           |
| KMGK    | KZZA    | Glenwood, MN          |
| KNTL    | KJIL    | Bethany, OK           |
| KNUI-FM | KHUI    | Kahului, HI           |
| KPLT-FM | KTXU    | Paris, TX             |
| KQOL    | KBER    | Spanish Fork, UT      |
| KRBL    | KKBR    | Los Alamos, NM        |
| KVVV    | KMGK    | Thief River Falls, MN |
| KWBR    | KPGA    | Pismo Beach, CA       |
| KWFS    | KKQV    | Wichita Falls, TX     |
| KXKT    | KOMJ    | Atlantic, IA          |
| KYZZ    | KTQN    | Belton, TX            |
| KZFF    | KTHO-FM | South Lake Tahoe, CA  |
| WAZY    | WAZY-FM | Lafayette, IN         |
| WECY-FM | WSUX-FM | Seaford, DE           |
| WHCM    | WMGP    | Parkersburg, WV       |
| WJMY    | WUAA    | Marquette, MI         |
| WJXN-FM | WYCH    | Utica, MS             |
| WKNW    | WKQC    | Canaan, VT            |
| WLIQ    | WWBR-FM | Harriman, TN          |
| WMKZ    | WPFC    | Monticello, KY        |
| WMMY    | WHLC    | Solana, FL            |
| WMPN-FM | WMAA-FM | Jackson, MI           |
| WMVM    | WMVW    | Mayville, WI          |
| WMXO    | WBJZ    | Olean, NY             |
| WOLF-FM | WHUH    | Houghton, MI          |
| WPUP    | WBIC    | Royston, GA           |
| WRAP    | WPCL    | Spotsylvania, PA      |
| WTDR    | WLVK    | Statesville, NC       |

## Changed AM Call Letters

| New  | Former |                     |
|------|--------|---------------------|
| KGDD | KPRE   | Paris, TX           |
| KINF | KXKW   | Lafayette, LA       |
| KJAA | KYOR   | Globe, AZ           |
| KJJO | KZOW   | St. Louis, MN       |
| KLNT | KCLN   | Clinton, IA         |
| KORC | KBBM   | Waldport, OR        |
| KRMD | KMJI   | Shreveport, LA      |
| KVOG | KZKZ   | Greenwood, AR       |
| KXEB | KBLN   | Sherman, TX         |
| KZIZ | KFRS   | Sumner, WA          |
| WASY | WDAK   | Alexander City, AL  |
| WCHB | WMKM   | Taylor, MI          |
| WCNT | WAME   | Charlotte, NC       |
| WECY | WSUX   | Seaford, DE         |
| WHNK | WRLT   | Madison, TN         |
| WHNR | WYXY   | Cypress Gardens, FL |
| WIWS | WCIR   | Beckley, WV         |
| WKGL | WPIX   | Huntsville, AL      |
| WKJQ | WTBP   | Parsons, TN         |
| WKXB | WSVT   | Smyrna, GA          |
| WLPZ | WWGT   | Westbrook, ME       |
| WMKM | WCHB   | Inkster, MI         |
| WPLO | WBIC   | Royston, GA         |
| WUBE | WDJO   | Cincinnati, OH      |
| WZCT | WSGG   | Scottsboro, AL      |

## Requests Withdrawn For Changed Call Letters

| Present | Wanted |                  |
|---------|--------|------------------|
| New     | WVEH   | East Hampton, NY |
| KFON    | KOKE   | Rollingwood, TX  |
| KUUS    | KZBO   | Billings, MT     |

## Applications For New FM Stations

|    |                |           |
|----|----------------|-----------|
| AL | Attala         | 102.9 MHz |
| AL | Warrior        | 98.7 MHz  |
| CA | Lenwood        | 107.3 MHz |
| CA | Redding        | 88.9 MHz  |
| CA | Sun City       | 92.9 MHz  |
| CA | Temecula       | 94.5 MHz  |
| CO | Buena Vista    | 104.1 MHz |
| FL | Baldwin        | 105.7 MHz |
| FL | Tallahassee    | 106.1 MHz |
| GA | Broxton        | 103.7 MHz |
| GA | Evans          | 92.3 MHz  |
| GA | Lumpkin        | 99.3 MHz  |
| GA | Martinez       | 107.7 MHz |
| IN | West Lafayette | 106.7 MHz |
| MI | Hillman        | 94.9 MHz  |
| MI | Hudson         | 102.5 MHz |
| MO | Savannah       | 92.7 MHz  |
| NJ | Manahawkin     | 105.7 MHz |
| NJ | Petersburg     | 102.7 MHz |
| NJ | Tuckerton      | 99.7 MHz  |
| NY | Jeffersonville | 106.1 MHz |
| OH | Hubbard        | 101.9 MHz |
| PA | Bethlehem      | 89.5 MHz  |
| TN | Bolivar        | 94.7 MHz  |

## Permits Granted For New FM Stations

|    |               |           |
|----|---------------|-----------|
| AL | Bay Minette   | 106.5 MHz |
| AL | Trinity       | 92.5 MHz  |
| AL | Winfield      | 105.9 MHz |
| AR | Texarkana     | 106.3 MHz |
| AZ | Claypool      | 105.5 MHz |
| CA | Garberville   | 104.7 MHz |
| FL | Rockledge     | 102.7 MHz |
| HI | Kewahae       | 106.9 MHz |
| IA | Winterset     | 95.9 MHz  |
| IL | Dwight        | 98.9 MHz  |
| IL | Nashville     | 104.7 MHz |
| IL | Woodlawn      | 106.9 MHz |
| KS | Liberal       | 102.7 MHz |
| KY | Williamsburg  | 104.3 MHz |
| ME | Harpwell      | 91.9 MHz  |
| ME | Kennebunkport | 104.7 MHz |
| MO | Warrenton     | 99.9 MHz  |
| MS | Monticello    | 102.1 MHz |
| NC | Kinston       | 102.9 MHz |
| NC | Rocky Mount   | 90.9 MHz  |
| ND | Langdon       | 95.7 MHz  |
| ND | Sarles        | 105.9 MHz |
| NJ | Freehold      | 89.7 MHz  |
| NJ | Ocean Acres   | 98.5 MHz  |
| NY | Mount Hope    | 90.1 MHz  |
| OH | Belpre        | 91.7 MHz  |
| OH | Lorain        | 89.1 MHz  |
| OK | Locust Grove  | 100.7 MHz |
| OK | Moore         | 88.1 MHz  |
| PA | Elizabethton  | 88.3 MHz  |
| PA | Huntingdon    | 106.3 MHz |
| PA | Marietta      | 88.7 MHz  |
| SD | Watertown     | 92.9 MHz  |
| TN | Loudon        | 105.3 MHz |
| TN | Rogersville   | 106.5 MHz |
| TX | San Diego     | 105.9 MHz |
| WA | Dayton        | 92.5 MHz  |
| WV | West Liberty  | 91.5 MHz  |

## Permits Granted For New AM Stations

|    |        |         |
|----|--------|---------|
| Al | Dothan | 700 kHz |
|----|--------|---------|

SHORTWAVE RECEIVERS. HAM RADIOS. ANTENNAS, SCANNERS. Business Radios. ICOM, YAESU, KENWOOD, SONY, MOTOROLA.

... our 40th Year ... Worldwide shipping.

Sales ... Service. Large Showroom. Open 7 days.

**Barry Electronics Corp.**  
WORLD WIDE AMATEUR RADIO SINCE 1950  
Your one source for all Radio Equipment!

212-925-7000 or Fax 212-925-7001  
512 Broadway, NYC, NY 10012

CIRCLE 44 ON READER SERVICE CARD

## CB RADIO OWNERS!

We specialize in a wide variety of technical information, parts and services for CB radios. 10-Meter and FM conversion kits, repair books, plans, high-performance accessories. Thousands of satisfied customers since 1976! Catalog \$2.

**CBC INTERNATIONAL**  
P.O. BOX 31500PC, PHOENIX, AZ 85046

## CABLE TV CONVERTERS

Why Pay A High Monthly Fee? Save \$100's A Year

- All Jerrold, Oak, Hamlin, Zenith, Scientific Atlanta, and more.
- 60 Day Money Back Guarantee
- Visa/MC and C.O.D.
- Shipment within 24 hours

**WE WILL BEAT ANYONE'S PRICE**  
No Illinois Orders Accepted

**Electronic Engineering**  
P.O. Box 337, Barrington, IL 60011  
Free catalog 1-800-542-9425 Information 1-708-540-1106

## Jo Gunn Enterprises

- CB Antennas
- Mobile Antennas
- 10 Meter Antennas
- Coax

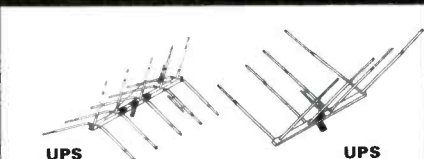

**UPS SHIPPABLE**  
'Local - Groundwave - DX'  
Combination Antenna  
JG 5 + 5 Star

**SPECIFICATIONS:**  
TYPE: Horz. & Vert.  
Polarization Twin Feed  
GAIN: 16.5 DB  
FRONT to BACK RATIO: 48 DB True  
SIDE REJECTION: 50-55 DB True  
BACK REJECTION: 40 DB True  
WEIGHT: 37 lbs.  
LENGTH: 17 ft., 6 in.  
SWR: 1.1  
HORZ. to VERT. SEPARATION: 25-30 DB  
WIND SURVIVAL: 100 MPH  
POWER MULTIPLICATION: 65X  
AUDIO GAIN: 22 DB  
WIND LOAD: 5.2

**UPS SHIPPABLE**  
'Strictly for DX'  
DX Antenna  
JG - 4V

**SPECIFICATIONS:**  
TYPE: Horz. & Vert.  
Polarization Single Feed  
GAIN: 15.5 DB on DX  
FRONT to BACK RATIO: 50 DB True  
SIDE REJECTION: 45-50 DB True  
BACK REJECTION: 35 DB True  
WEIGHT: 24 lbs.  
LENGTH: 12 ft.  
SWR: 1.1  
WIND SURVIVAL: 100 MPH  
POWER MULTIPLICATION: 50X  
WIND LOAD: 2.8

ALL CANADIAN INQUIRIES CONTACT:

**SALES CANADA INC.**  
5035 NORTH SERVICE RD. UNIT D-16  
BURLINGTON, ONTARIO  
L7L 5V2  
Tel: 1-416-332-5844 Fax: 1-416-332-5846

Call or Send \$2.00 for Complete Catalog and Pricing of Antennas.



Route 1 - Box 32C, Hwy. 82  
Ethelsville, AL 35461  
**(205) 658-2229**  
Hours: 10 am - 6 pm (CST)  
Monday - Friday

DEALER INQUIRIES, PLEASE CALL

### Applications For AM Facility Changes

|      |                  |   |
|------|------------------|---|
| New  | Hawley, TX       | 1600 kHz Move to Hamby, TX 880 kHz, 5/1 kW                    |
| KFRD | Rosenberg, TX    | 1240 kHz Increase to 5 kW days                                |
| KKMC | Gonzalez, CA     | 880 kHz Move to Del Rey Oaks, 50/2.5 kW                       |
| KJTT | Oak Harbor, WA   | 1110 kHz Move to 1520 kHz, 1 kW                               |
| KTCD | Eureka, CA       | 1200 kHz Move to Cottonwood, run 2.5 kW nights                |
| KTSJ | Pomona, CA       | 1220 kHz Increase to 930 watts days                           |
| KWWJ | Baytown, TX      | 1360 kHz Increase to 5 kW days                                |
| WHND | Monroe, MI       | 560 kHz Install synchronous 15 watt transmitter at Birmingham |
| WIXK | New Richmond, WI | 1590 kHz Drop to 3.9 kW                                       |
| WJDQ | Marion, MS       | 1240 kHz Move to Meridian, MS                                 |
| WKNV | Dublin, VA       | 810 kHz Drop to 350 watts                                     |
| WLVN | Luverne, AL      | 1080 kHz Move to Brantley, AL                                 |
| WMTI | Morovis, PR      | 1580 kHz Increase to 10 kW days                               |
| WPZA | Ann Arbor, MI    | 1050 kHz Increase to 10 kW days                               |
| WTGC | Lewisburg, PA    | 1010 kHz Drop to 1 kW   |

### AM Facility Changes Approved

|      |                    |                                  |
|------|--------------------|----------------------------------|
| WAMY | Amory, MS          | 1580 kHz Drop to 1 kW days       |
| WCUE | Cuyahoga Falls, OH | 1150 kHz Increase to 5 kW days   |
| WGCL | Bloomington, IN    | 1370 kHz Increase to 1 kW nights |

### Applications For FM Frequency Changes

|         |                |                           |
|---------|----------------|---------------------------|
| KAVI-FM | Rocky Ford, CO | 95.9 MHz Seeks 95.5 MHz   |
| KBBQ    | Ft. Smith, AR  | 100.9 MHz Seeks 100.7 MHz |
| KDDQ    | Comanche, OK   | 96.7 MHz Seeks 96.9 MHz   |
| KJFM    | Louisiana, MO  | 101.7 MHz Seeks 102.1 MHz |

### FM Frequency Changes Approved

|         |                |                        |
|---------|----------------|------------------------|
| KCVO    | Camdenton, MO  | 90.7 MHz To 91.7 MHz   |
| KNIQ    | Mason City, IA | 93.5 MHz To 93.9 MHz   |
| KRZZ-FM | Derby, KS      | 95.9 MHz To 96.3 MHz   |
| KTOZ-FM | Marshfield, MO | 104.9 MHz To 104.7 MHz |
| KXRA-FM | Alexandria, MN | 92.7 MHz To 92.3 MHz   |

### AM Call Letter Changes Requested

| Present | Seeking |                      |
|---------|---------|----------------------|
| KCLN    | KLNT    | Clinton, IA          |
| KMJC    | KECR    | El Cajon, CA         |
| KPBC    | KGGR    | Dallas, TX           |
| KZAM    | KHNN    | Springfield, OR      |
| KZAO    | KWXT    | Dardanelle, AR       |
| WKJR    | WQWQ    | Muskegon Heights, MI |
| WVIN    | WABH    | Bath, ME             |

### FM Call Letter Changes Requested

| Present | Seeking |                      |
|---------|---------|----------------------|
| KAIO-FM | KCJC    | Russellville, AR     |
| KISY    | KLAA    | Tioga, LA            |
| KLVU-FM | WVHN-FM | Haynesville, LA      |
| KPHN    | KOLX    | Barling, AR          |
| KQHK    | KIUS    | Hutchinson, KS       |
| WQWQ    | WQFN    | Muskegon Heights, MI |
| WUBE-FM | WUBE    | Cincinnati, OH       |
| WURB    | WDJB    | Windsor, NC          |
| WXNL    | WJMY    | Baraga, MI           |
| WYGL-FM | WLIZ    | Elizabethville, PA   |
| WZNL    | WNWY    | Norway, MI           |

structions. The FCC authorizes translators on a secondary basis and imposes rules that restrict their service, ownership, financial support, and program origination.

Of late there has been some discussion in various quarters in modifying the rules governing translators, for instance, permitting original programming to be presented. In response, the FCC set forth some proposals for restructuring the rules governing translators. Specifically, they propose to revise and clarify those rules, and add new rules covering ownership, financial support, major changes in the translator service area, fre-

quency assignments, interference criteria, and technical requirements.

Basically, the FCC still feels that translators should remain a secondary service intended to extend the signal areas of FM stations. They do allow translators to provide emergency warnings of imminent danger, but that's about all of the "original programming" permitted except for a half-minute per hour to solicit financial support. They don't want a new low-power FM service.

The proposed restructured rules would prohibit the primary FM station (the one whose programs are being relayed) to own

or support (even indirectly) any translator simulcasting their signals. There are 1815 FM translators.

*Keeping Records?* For those keeping track of stats, there are 4977 AM stations in the USA, plus 4243 commercial and 1424 non-commercial FM stations. There are a total of 1446 VHF/UHF TV stations, plus 4927 TV translators, and 649 low-power TV stations.

*WKRP in Cincinnati.* Lovers of the old TV sitcom about WKRP, the fictitious radio station in Ohio will be pleased to learn that it looks like a new version of the program is getting set for production in about a year. A few members of the original cast may return, but it looks like it will be mostly new faces around the station. We look forward to this new show, probably for the 1991-92 season.

*Frozen Out.* As of early last April, and FCC freeze has been in effect that blocks applications for AM facility modifications and also new station applications. This was done in anticipation of the opening up of the 1605 to 1705 extension of the band. While a few applications for minor changes (resulting from conditions beyond the control) of the applicant, mostly the FCC wants to rework the rules on several levels (taking into account the new frequencies) before running any more new AM modifications or licenses through the processing mill.

This column invites photos of AM or FM broadcasting facilities, also current QSL cards, bumper stickers, decals, and news clippings regarding broadcasters.

## ASSOCIATED RADIO

8012 CONSER BOX 4327  
OVERLAND PARK, KANSAS 66204

CALL 913-381-5900

FAX 913-648-3020

**SHORT WAVE  
AMATEUR  
RADIO**

*New and reconditioned equipment.*  
**BUY—SELL—TRADE—SERVICE**

**CALL FOR  
YOUR  
LISTENING  
NEEDS**



**Send \$3.00 for our current catalog and wholesale sheet.**

Please send all reader inquiries directly.

# CLANDESTINE COMMUNIQUE

WHAT'S NEW WITH THE CLANDESTINES

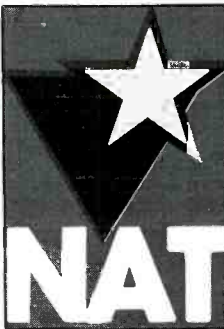

## THE CUBAN AMERICAN NATIONAL FOUNDATION

The Cuban American National Foundation produces *La Voz de fundacion* aired over WHRI in Indiana, and supplies listeners with this bumper sticker.

The pro-democracy, anti-Chinese government *Voice of June 4th* broadcast mentioned here in recent columns have now been spotted on shortwave. They're being aired over the shortwave facilities of the Taiwan government—frequencies used by the Broadcasting Corporation of China. The reported schedule for the *Voice of June 4th* is as follows: 0250-0340 on 7250, 0615-0800 on 7150, 7250 and 11905, 0915-0955 on 7150 and 11905, 1030-1200 on 7150, 7250 and 11905, 1530-1830 on 7150, 7250 and 11905, 2100-2200 on 15280, 2215-0020 on 7150, 7250 and 11905. All broadcasts are in Chinese. Reception reports may be sent to the Independent Federation of Chinese Students in the USA, P.O. Box 15-7939, Chicago, IL 60615. We still can't figure why this group felt it necessary to keep the name of the station doing the broadcasting a secret. Thanks to well-known Danish DX'er Finn Krone via a private news source for the information.

Also on the China front, *The Voice of Democracy* in China is a new anti-government broadcasting effort which was to begin in April. The station will operate from a ship called the "Goddess of Democracy", from the seas off the China coast. The project is being funded by the Federation for Democracy in China (FDC) using funds provided by some 17 French magazines. The FDC membership includes a number of French and Taiwanese journalists. Besides the shipboard transmitter backers hope to have several land-based relays near China's borders. Broadcasts, at least from the ship, will be on medium wave only.

By the time these words reach you it's quite likely that the longtime radio voices of the Nicaraguan contras will have gone silent. The contras were scheduled to disband in April so by now we may have heard the

last of *Radio Quince de Septiembre*, *Radio Liberacion* and *Radio Miskut*.

The Cuban American National Foundation's *La Voz de Fundacion* program over WHRI has now begun to verify reception reports. Reports on this regularly scheduled anti-Castro program can be sent to Ninosa Perez, Cuban American National Foundation, P.O. Box 440069, Miami, FL 33144.

In his April clandestine column in the bulletin of the Association of Clandestine Enthusiasts (ACE) George Zeller makes the excellent point that we should all be keeping a close ear on *Radio Impacto* in Costa Rica (5030/5044 and 6150) which has backed Washington's Central American policies right down the line and have devoted a lot of time to anti-Sandinista programming.

Incidentally, an item in the March 12 issue of *Newsweek* indicates "the CIA funded radio broadcasts to Nicaragua from Costa Rica (though to appear non-partisan they were prohibited from interviewing UNO (United Nicaraguan Opposition—editor) officials." Is this a reference to *Radio Impacto*? Oddly, journalists Robert Perry and Douglas Waller did not respond to our written request for more details.

The UNITA station, *Voice of the Resistance of the Black Cockerel*, is making some changes which indicate that probably none of the station's broadcasts come from within South Africa any longer, but only from Jamba in UNITA-held territory in southern Angola. We have two different schedules: (a) 0500 on 7145 and 1200 and 1900 on 9850 and (b) 0800-0815 on 9700, 1215-1225 on 11830 and 2100-2200 on 6255.

*Radio Siboney*, another anti-Angolan government station which we've never known much about is said to be operating from 1900 to around 2030 on 6100. Longtime South African-based monitor Vashek Korinek, who supplies this schedule, says

he believes the station may be US-funded. He hears an address announced which sounds like Centro del Pueblo de Cuba, P.O. Box 450214, Miami FL 33245. The station's programs are intended for Cuban troops in Angola.

*La Voz de Fundacion* has been heard via WHRI on 7315 and 9495 at 0100-0158 by R.C. Watts in Kentucky and 7315 at 0115 by Robert Ross in Canada.

The Croatian liberation program, *Radio Libertas*, produced by the Croatian committee for Human Rights, has been QSL'd by Robert Ross. A QSL card was received from the organization's Canadian headquarters at 1174 Clarkson Road South, Mississauga, Ontario, L5J 2W2, Canada. The program airs daily at 1600 on 11790 and 21840.

We continue to get conflicting reports on the status of the *Voice of Malayan Democracy*. The latest is that the station remains active, despite a peace treaty signed by the government and the Communist Party of Malaysia. This once can sometimes be heard in North America—try from 1215 sign on on variable 6700. Programming is in Malaysian and Chinese.

The anti-Zimbabwe station, *Radio Truth*, (based in South Africa) is being heard again by some US monitors. Check for this one from 0430 when the station signs on with a bird call interval signal on 5015. The first part of the broadcast is in English.

Remember to forward to this column any items you may have relative to clandestine radio matters. That includes your loggings (please make them separate from logs sent to the Listening Post), QSL information, related news articles, material received from stations or their backers and anything else you may feel would be of interest. We can protect your identity if you wish.

More next month. Until then—good hunting!

PC

## THE EXCITING WORLD OF RADIOTELETYPE MONITORING

**S**am Ricks of Pennsylvania concentrates some of his RTTY monitoring efforts on following the operations of the Soviet space-flight tracking ships. Recent loggings of his appeared in last February's column, and including UVAU, Borovich; and UIVZ, Kosmonaut Vladislav Volkov.

In a follow up letter, Ricks provided a very informative—and technical—paper on the operations of another tracking ship, UZYY, NIS Kosmonaut Viktor Patsayev, as it sailed from its usual position off Montevideo, Uruguay, to another in the South Atlantic Ocean, to track the Mir Space Complex after an orbital maneuver last January. Orbital data, called F-2 schedules, are sent by RTTY from the ship to "Science One" in Moscow. The data is used to reposition other tracking ships to maintain continual coverage of the satellite's orbits, Ricks says.

Figure 1 shows an example of the RTTY data that was sent by the Patsayev. Ricks says the first data line contains the date and latitude/longitude position of the tracking ship. In the example, 21010 35211 48151 is read as 21-0100, or 21 January 1990. The tracking ship is located at 35 degrees 21 minutes South, 48 degrees 15 minutes West, a position that is east of Montevideo. The last digit is the quadrant number, with 1 used for South and West, and 0 for North and East.

The next several data lines contain the orbit number, the time Mir's signal is first heard as it rises above the horizon, the time the signal is lost as Mir goes below the horizon, and Mir's highest elevation in degrees above the horizon. Referring again to the example, 2518 104231 105220 0019 is read as orbit number 22518; the signal was first heard at 10:42:31 Moscow time, which is UTC plus three hours; the signal was lost at 10:52:20; and the highest elevation was at 19 degrees above the horizon.

You too can monitor similar data by setting your decoders to 170/50N and tuning to frequencies such as 6268 and 8299.5, which appeared in last February's column, at about 0200 UTC. Good luck in your efforts, and be sure to share your results with the rest of us.

A ribbon of TTY tape to Ricks for the splendidly detailed report he wanted us to share with you. Glad to be of service!

From the mailbag: "Bunky" of Illinois writes, "I have copied what appears to be a TOR/ARQ transmission on 22854 at 1545Z. The only thing that appears unusual is that the shift is 425 Hz . . . Any ideas what this might be?"

I also have monitored this station umpteen times between 1325 and 1715 using ARQ/425. It's always on standby for long

periods and seems never to send any ttc. Therefore, I cannot provide an answer at this time. Maybe another reader has had better luck?

| Abbreviations Used in The RTTY Column |                                   |
|---------------------------------------|-----------------------------------|
| AA                                    | Arabic                            |
| ARQ                                   | SITOR mode                        |
| BC                                    | Broadcast                         |
| EE                                    | English                           |
| FEC                                   | Forward Error Connection mode     |
| FF                                    | French                            |
| foxes                                 | "Quick brown fox . . . "test tape |
| GG                                    | German                            |
| ID                                    | Identification/led                |
| MFA                                   | Ministry of Foreign Affairs       |
| nx                                    | News                              |
| PP                                    | Portuguese                        |
| RYRY                                  | "RYRY . . . "test tape            |
| SS                                    | Spanish                           |
| ttc                                   | Traffic                           |
| w/                                    | With                              |
| wx                                    | Weather                           |

**2233:** Un-ID, possibly German, w some text in GG, FDM ARQ-E/72 at 1914 (Peter T., England). Could be part of the FRG's National German Network—Ed.

**3896:** RFFXC, Versailles, France, w a test msg to RFFHC, Marseilles, ARQ-E 401/72 at 2005 (Peter T., England).

**4051:** Un-ID, presumably French military, idling, ARQ—E/48 at 1100, then "de Contentin" (Peter T., England).

**4480:** GYA, Royal Navy, London, England, w foxes at 1812, 850/75N (Peter T., England).

**4813:** LZA8, Sofia Meteo, Bulgaria, w/coded wx, 425/50R at 0427 (Steve Black, NY).

**5135:** KAA60, FCC, Grand Island, NE, w "This concludes the test of our radio net. All stations secure from radio net and resume normal operations." Was 425/50R, at 0434. Also found another day at 0317 w bit-inversion. 425/45N (Black, NY).

**5240:** 40C2, TANJUG, Belgrade, Yugoslavia, w/RYRY + freq list at 0351. 425/50N (Black, NY).

**5818.5:** 9HA, Luqa Aero, Malta, w coded wx at 0424, 425/50R (Dallas Williams, CO).

**6264:** Russian Cyrillic ttc, headed Radio Odessa, noted at 0211, 170/50N (Williams, CO). This freq is in the midst of a cluster used by Soviet merchant vessels to send ttc to their home ports—Ed.

**6941.5:** TRK, ASECNA, Libreville, Gabon w aero wx at 2103, 500/50R (Black, NY).

**6943:** 5TX, ASECNA, Nouadhibou, Mauritania, w aero wx, ARQ-E3/48 at 0353 (Ed.).

**7407:** CML5, RCC, Havana, Cuba, w foxes, 425/50N at 0055 (Black, NY).

**7625:** HZN47, Jeddah Meteo, Saudi Arabia, w coded wx, 850/100R at 0218 (Black, NY).

**7642:** USN MARS sta NNNOFZQ w relay of MARSgrams from Japan to NNNOKZH, packet 1030/300 at 0300 (Ed.).

**7709.4:** Un-ID w 5F grps in ARQ at 2054 (Peter T., England).

**7850:** ZAA, ATA, Tirana, Albania, w/RYRY and nx in FF, 425/50R at 1900 (Black, NY).

**7968.2:** Un-ID w "MG de Kosutaria to Nikaragua Urgent Nikaragua," foll by 5L grps and text in un-ID lang. In midst of msg was "no passport." Msg ended w "TL/TKS BIBI NOW CUTN." Was ARQ at 2300 (Fred Hetherington, FL).

**7973.5:** SPW, Warsaw R., Poland, w ARQ ttc at 0154 (Ed.).

**7991:** USN MARS sta NNNORMC clg NNNOZLS, packet 1030/300 at 0205 (Ed.).

**7995.4:** USN MARS sta NNNOFRQ w foxes, 10

count, RY's, foll by relay of MARSgrams. Was 85/75R at 0108 (Ed.).

**8030.5:** ASECNA, Niamey, Niger, w RYRY at 2218, 170/50N (Black, NY).

**8105.5:** OFA, Helsinki R., Finland, w a Telex to a ship, Arq at 2031 (Peter T., England).

**9252.2:** ELRB, Monrovia Aero, Liberia, w/RYRY + QJHI, 350/50N at 0155 (Black, NY).

**9280:** FJY4, Marin de Vivies Meteo, St. Paul and Amsterdam Island, w coded wx at 0133, then RYRY, 425/50N (Manthey, NY).

**9318:** DHJ51, Greleng Meteo, FRG, w plaintext wx at 0200 foll by coded wx at 0205, 500/100R (Black, NY).

**9380:** "OO RBTJ de RBDT NFT" w RYR RYR and "all good men" (see figure 2—Ed.) at 0402, one night, and at 0519, the foll night, 850/50R (Williams, CO). This appears to be from the RAF, London, England (RBDT), which has radio circuit on this freq., to a squadron at Gibraltar—Ed.

**10105:** RKA79, TASS, Moscow, USSR, w nx in EE, 425/50R at 0528 (Ed.).

**10200:** JAE50, JIJI, Tokyo, Japan, w nx in SS at 1150, 850/50R. At 1155, the nx was interrupted w "CQ CQ de JAL-21 This is a newscast to South America," then returned to nx in SS (Hetherington, FL). It appears the TTY op grabbed the wrong test tape, for the JAE50 c/a is correct for this freq. JAL21 is assigned to 11012.5—Ed.

**1357.1:** Un-ID w ARQ ttc in Dutch at 2040 that mentions movie "Top Gun" (Peter T., England).

**10414:** SNN299, MFA, Warsaw, Poland, w/RYRY, CQ and c/s at 0555, 170/75N, foll at 0602 w ttc in Polish and 5F grps to embassies in Europe and Ottawa, ON (Ed.).

**10419:** ETD3, Addis Ababa Aero, Ethiopia, w/coded wx at 0430, 425/50N (Joe Palkovic, FL., via Hetherington, FL).

**10895:** LRB39, TELAM, Buenos Aires, Argentina, w nx in SS, 796/50R at 234 (Hal Bilodeau, IL).

**11010:** GYA, Royal Navy, London, England, w a test tape at 0347, 850/75R (Williams, CO).

**11027.6:** Un-ID w RYRY + "Zaire Centre line test," at 0500, 425/50R ("Bunky," IL). It's 9PL, Kinshasa Aero, Zaire—Ed.

**11065:** YAV25, Kabul Aero, Afghanistan, w RYRY at 0222, 500/50N (Williams, CO).

**11604:** Un-ID w TANJUG nx in EE at 0450, 425/50R ("Bunky," IL). It's YZJ3, TANJUG, Belgrade, Yugoslavia.

**12065.9:** Possibly EPD, Teheran Aero, Iran w coded wx at 0040, 170/50N. Very weak sig (Williams, CO).

**12100.8-12102.8:** Un-ID, possibly ZLX42, Himantangi Navrad, New Zealand, w/foxes, 10 count, and TEST, on 7 of 9 FDM channels, 170/75N at 1455. The other 2 channels ran encryption (Ed.).

**12154.4:** Mexican "radiogramma" re the wx, 170/75R at 0235. Appears sporadically throughout the day. Sta uses special character set with shifted G being n (Williams, CO).

**12176:** Possibly KUNA, Safta, Kuwait, w nx in AA at 1543, 325/50N (Williams, CO). If so, the c/s would be 9KT291—Ed.

**12180:** Possibly Y7L36, GDR Embassy, Havana, Cuba, w/5F msg's at 1543, 500/50R. QRUSK at 1546 (Ed.).

**12265:** BZR62, XINHUA, Beijing, China, w nx in EE, 425/75R at 1623 (Williams, CO).

**13552.9:** Un-ID U.S. mil. w AP nx and wx, FDM 85/50R at 2023 (Ed.).

**13541:** Un-ID w coded meteo for South Africa at 0611, 455/75N (Bilodeau, IL). It's Pretoria Meteo, RSA—Ed.

**13751:** HZJ, Jeddah Meteo, Saudi Arabia, w coded wx at 0600, 425/50N (Bilodeau, IL).

**13813.6:** CXR, Montevideo Navrad, Uruguay, w RYRY/SGSG, 850/75N at 2327 (Manthey, NY).

**13814.2:** Pertamina, Jakarta, Indonesia, idling in

ARQ, 1131-1143, then s/off only w "GY JKT" (Ed.).

**13872.6:** HGX51, un-ID Hungarian embassy, w/RYRY to HGX21, Budapest, 425/100 at 1500 (Hetherington, FL).

**13874.3:** CLP1, MFA, Havana, Cuba, w/RYRY, then circulars in SS, 515/50N at 2300 (Hetherington, FL).

**13895:** Y2V47, ADN, Berlin, GDR, w/nx in AA, 425/50N at 1855 (Ed.).

**13941.5:** "Q1S," w msgs in FF, and QSL's in FF to 5L msgs sent by other stas, FEC at 2133, Q1S had a very strong sig compare with the other stas which also were on this freq. These other stas gave ID's of "QSM," "6FN," and "LNV." Xmsn ended at 2345. Some FF abbrevs used in QSL's were "MCI," merci (thanks); "VCI," voici (here); "SVP," s'il vous plait (if you please); "BN," bon nuit (good night); and "BSR." The BSR abbrev was written out in full at one point as "bon s'hour," which sounds similar to the FF "bon jour" (good day). It also could be considered to mean "bon soir" (good evening) (Ed.).

**13964:** AAAOUSA, U.S. Army MARS, w a s/off msg AAT9TQ, ARQ at 2150 (Ed.).

**13977.7:** FDZ, French Air Force, Paris, France, w/tfc to RFFVAD, N'Djamena, Chad, TDM2 280/200, at 0200 and 2120. It appears that the FAF is switching over slowly from ARQ to 200 baud TDM2 (as compared to 200 baud TDM4—Ed.) (Hetherington, FL).

**13987.5:** OST, Oostende R., Belgium, w/telexes to ships, ARQ at 2127 (Ed.). Same at 1220 and 1330 (Hetherington, FL).

**14339.6:** Beijing Meteo, China w coded wx at 0404, 850/50N. The c/s is either BAF47, BAA7, or BAL47 (Williams, CO). BAF47 is the correct one—Ed.

**14367.3:** BZP54, XINHUA, Beijing, China, w/nx in FF at 1321, 4525/50R (Ed.).

**14373:** YIL73, INA, Baghdad, Iraq, w/nx in AA, 425/50R at 1127 (Ed.).

**14403.5:** Un-ID w/nx in EE, 850/50R at 1326. Severe QRM from glissando-like noises. Xmsn ended at 1345 (Ed.).

**14452:** HMF57, KCNA, Pyongyang, North Korea, w/nx in FF at 1158, 300/50R (Ed.).

**14497.5:** CSY66, Santa Maria Aero, Azores, w/aero wx data at 2030, 850/50R (Black, NY).

**14597:** SOO259, PAP, Warsaw, Poland, w/nx in Polish, FEC at 1335 (Hetherington, FL).

**14786.5:** 9PL, Kinshasa Aero, Zaire, w/RYRY, 425/50N at 2119 (Ed.). Same sta on 14788 w/aero msgs at 2334, 398/50N (Hal Blodeau, IL).

**14795:** BZM45, XINHUA, Beijing, China, w/RYRY and QRA at 1255, and nx in EE at 1259, 425/50R (Ed.).

**14880:** JMG4, Tokyo Meteo, Japan, w/coded wx data for the Asian part of the USSR, 796/50R at 0150 (Blodeau, IL).

**14901:** CLN451, TASS, Havana, Cuba, w/nx in EE, 399/50N at 1415 (Blodeau, IL). Same at 1520, 850/50 (Charlton, ON).

**15050:** "Mailbag," w/crypto to MacDill AFB, FL, 850/75 at 1500. Went to USB at 1504 and gave "Mailbag" ID (Hetherington, FL).

**15593:** KRH51, U.S. Embassy, London, England, w/foxes at 2005, 850/75N (Black, NY).

**15633:** RCA55, Moscow, USSR, w RYRY + ID at 1230, 200/50N (Manthey, NY). Must be a new sta. None of my refs list this c/s—Ed.

**15705:** YZJ6, TANJUG, Belgrade, Yugoslavia, w/nx in FF, 425/50R at 1621 (Ed.).

**15833:** Un-ID w 5F grps, 0425-0428, 500/75N (Williams, CO).

**15892.4:** Un-ID w mil-style tfc at 0355, 500/50N. Just too weak to ID. Lang almost looked like Cyrillic, but error rate too high to be sure (Williams, CO).

**15935:** SUA291, MENA, Cairo, Egypt, w/nx in FF and EE, 250/50R at 1714 (Ed.).

**16006.7:** Un-ID diplo w ARQ msgs in AA signed Ambassador Adel Zaki at 1350 (Ed.).

**16015:** MFA, Sofia, Bulgaria, w/crypto after DDDDD, 425/75N at 1414 (Ed.).

**16043:** CLP65, Embacuba, Managua, Nicaragua, w/tfc to CLP1, 425/100R at 0040 (Palkovic, FL, via Hetherington, FL).

**16145:** RWM77, APN, Moscow, USSR, w/nx in EE at 1215, 355/100R (Hetherington, FL).

**16234:** Possibly GDR Embassy, Havana, Cuba, w/5L msgs, 500/75R at 1431. S/off 1515 w GB SK. Returned 1600-1605 w rptd "Y's" and a "GA?". To CW w "VVV AIR" rptd (AIR being a tactical ID, and not that of

USAF MARS HQ), foll by more RTTY Y's and into 5L msgs at 1608. S/off 1630 w GB SK (Ed.).

**16308:** Y7A66, MFA, Berlin, GDR, w msgs to New Delhi, India, at 1632, 425/50R; then to Hanoi, Vietnam, at 1638 (Ed.).

**16336.5:** FZS63, Regional Meteo Center, St. Denis, Reunion, w/pos rpt in FF and EE on a cyclone, 425/50R at 1317. Then RYRY and xmsn schedule for HXP, 8176 kHz, and FZS63 on the freq. Moved to the lower freq at 1325 (Hetherington, FL).

**16372.3:** 8WB4, Indian Embassy, Teheran, Iran, w msgs in EE and in an un-ID lang, 470/50N at 1215 (Hetherington, FL).

**16506.7:** XBRJ, Mexican Navy, La Paz, Baja California Sur, w naval msgs in SS, ARQ, 1417-1440 (Ed.).

**16607:** Un-ID w a lengthy msg in 5F grps, 1353, 1409, 500/50N. Ended xmsn w no s/off (Ed.).

**17134.5:** UNM2, Klaipeda R., Lithuania SSR, w kriptogrammas, 170/50R at 2005, then to CW at 2011 (Black, NY).

**17139:** "72JKL," Madrid Navrad, Spain, w encryption at 2017, 850/75R (Charlton, ON).

**17183:** Y5M, Ruegen R., GDR, w worldwide QTH's of GDR merchant ships, FEC, 1654-1700 (Ed.).

**17200:** WLO, Mobile R., AL, w ARQ tfc at 2151 (Charlton, ON).

**17208.5:** SVT6, Athens R., Greece, w nx in Greek, FEC at 2109 (Ed.).

**17632.5:** SUU, Cairo Meteo, Egypt, w coded wx, 425/50R at 1315 (Ed.).

**18050:** RQV70, APN, Moscow, USSR, w RYRY s nx in FF at 1445, 425/50R (Manthey, NY).

**18215:** VOA, Greenville, NC, w nx in SS, 425/75R at 2102 (Charlton, ON).

**18510:** Embacuba, Lima, Peru, w cables containing 5F grps, 2115-2145 on a Saturday, 500/75R (Ed.).

**18543.5:** STK, Khartoum Aero, Sudan, w/RYRY, 425/50N at 2110 (Ed.).

**18634:** CLP1, MFA, Havana, Cuba, w a 5F msg to Embacuba Guyana, 425/100N at 1423 (Ed.).

**18635:** Un-ID w "minrex" and 5F grps crypto, 425/100N at 1750 ("Bunky, IL"). Same sta as on 18634—Ed.

**18993.5:** SPW, Warsaw R., Poland, working Polish merchant ships in ARQ at 1725 (Ed.).

**19058.7:** PWZ, Rio de Janeiro Navrad, Brazil, w/unclas telexes in PP, 75N at 1432 (Ed.).

**19105:** RPT34, TASS, Moscow, USSR, w/nx in FF, 425/50R at 1346 (Ed.).

**19117.5:** MFA, Jakarta, Indonesia, w/nx in EE, ARQ at 1435 (Ed.).

**19209.6:** RYRY from TASS at 1526, 425/50R. This is an AA service and I have no listing. Logged several times in recent months (Williams, CO). This is RCC79 from Moscow. My computerized data base shows this freq to be used for nx in AA, 19210 for nx in FF, PP, and RR; and 19210.5 for nx in EE. The FF BC I always pick-up w an 850 Hz shift, the other languages at 425 Hz shift. This seems to be consistent after years of monitoring RCC79—Ed.

**19210:** RCC79, TASS, Moscow, w/nx in FF, 850/50R at 1515 (Ed.).

**19227:** "DFZG," MFA, Belgrade, Yugoslavia, w/nx in SC, 425/75N at 1512 (Ed.).

**19235:** RWW70, TASS, Moscow, USSR, w/nxx in FF, 850/50R at 1516 (Ed.).

**19263.5:** CLP33, Embacuba, Addis Ababa, Ethiopia, w/RYRY + "este es CLP33" + more RYRY and "haciendo prueba," 500/50N at 1334. Foll at 1335 by telexes and crypto after ZZZZ to CLP1 and CLP25 (Ed.).

**19400:** "This is RTH New Delhi testing" + RYRY, foxes, and 10 count, 170/50R at 0244. This should be VVD67. I don't know what RTH means (Williams, CO). This is VVD69, New Delhi Meteo, India. The c/s you cited is on 18542 kHz. Sorry, can't help you w "RTH"—Ed.

**19505:** RCD36, PL, Moscow, USSR, w/nx in PP at 1323, 425/50N (Ed.).

**19529:** JMG5, Tokyo Meteo, Japan, w/coded upper air rpts from a/c flying over Asia, 806/50R at 0217 (Blodeau, IL).

**19671.5:** MFA, Rome, Italy, idling in ARQ, 1233-1240, then gives a QSL, ending the xmsn (Ed.).

**19822.5:** 5AF, Tripoli Aero, Libya, w/QJH HLLTYF + RYRY, 425/50R at 1752. HLLTYF is the ICAO ID for Tripoli Int's Aport (Ed.).

**19860:** GYA, Royal Navy, London, England, w/a test tape at 2024, 850/75R (Ed.).

**19865.5:** YZJ4, TANJUG, Belgrade, Yugoslavia, w/nx in SS pooled from various nx agencies, 425/50R at 1540 (Ed.).

**19875:** CLP1, MFA, Havana, Cuba, w/tfc in SS to CLP75, and CLP23, 480/50N at 2100 (Hetherington, FL). TAD, MFA, Ankara, Turkey, apparently w nx in Turk at 1500, 850/75R (Williams, CO).

**19980:** 9BC33, IRNA, Teheran, Iran, w/nx in EE, 425/50R at 1533 (Ed.).

**20372:** IRS23, ANSA, Rome, Italy, w/nx in EE at 1550, 425/50N ("Bunky," IL).

**20381:** Un-ID w synoptic wx data at 0000, 850/50N ("Bunky," IL). This sta is CAK, Santiago Aero, Chile—Ed.

**20882:** DFZG? Crypto after ZPZPZP, 425/75N at 1620 ("Bunky," IL). Yes, it is DFZG, MFA, Belgrade, Yugoslavia—Ed.

**22888:** Un-ID Polish diplo w/tfc in Polish, 425/75N at 1535 ("Bunky," IL). According to my records, this might be MFA, Belgrade, Yugoslavia, which I have logged on this freq w nx in FF at 1611, same TTY settings—Ed.

**22967:** HBD20? 5L grps crypto noted at 1520 in ARQ ("Bunky," IL). This could be HBD20, MFA, Berne, Switzerland—or a Swiss diplo post—which has used freqs near this one—Ed.

**23050:** Un-ID w "minrex" tfc in SS, 600/50N at 1515 ("Bunky," IL). CLP1, MFA, Havana, Cuba—Ed.

**23211.7:** Un-ID w an ARQ msg in PP (Hetherington, FL). No time given—Ed.

**23355:** CLP1, MFA, Havana, Cuba, w/5F msgs + Prensaminrex nx to Embacuba Tanzania, 1957-2014, 500/50N (Ed.).

**23356.5:** Un-ID w s/off msg in II, "ciao e di niente by by," ARQ at 1454 (Ed.).

**23357.2:** Un-ID w occasional tfc in AA and EE, 125-1500, ARQ/500 (Ed.).

**24006.7:** MFA, Islamabad, Pakistan, w/tfc in EE, ARQ at 1335 (Ed.).

**24078:** CLP25, Embacuba, Maputo, Mozambique, w a circular in SS, 500/50N at 1508 (Williams, CO).

**24613.3-24614.7:** GXQ, British Army, London, England, w foxes, 10 count, and RY's, 350/50N or R on 7 FDM channels (Ed.).

**24850:** RFLI, French Navy, Fort de France, Martinique, w a final msg of the day at 1418, TDM 96, channel A (Ed.).

**25020.5:** UXO, Krymskoi R., Sevastopol, USSR, w msgs in RR to several ships, 170/50N at 1335 (Hetherington, FL).

**25271.5:** ISX25, ANSA, Rome, Italy, w nx in EE, 425/50N (Ed.).

**25419.4:** DMK, MFA, Bonn, FRG, w tfc in GG to embassies at 1325, ARQ-E 170/96 (Hetherington, FL).

**25420.6:** DMK w nx in FF re German reunification, ARQ-E 170/96, at 1450 (Hetherington, FL).

**25421.5:** Un-ID FRG diplo w s/off in GG at 1230, ARQ-E 170/96 (Hetherington, FL).

PC

\*\*\*\*\* PRESENTING \*\*\*\*\*  
**CABLE TV  
DESCRAMBLERS**  
\*\*\*\*\* STARRING \*\*\*\*\*  
**JERROLD, HAMLIN, OAK**  
AND OTHER FAMOUS MANUFACTURERS

- FINEST WARRANTY PROGRAM AVAILABLE
- LOWEST RETAIL/WHOLESALE PRICES IN U.S.
- ORDERS SHIPPED FROM STOCK WITHIN 24 HOURS

FOR FREE CATALOG ONLY 1-800-345-8927  
FOR ALL INFORMATION 1-818-716-5914

**PACIFIC CABLE CO. INC.**  
7325 1/2 RESEDA BLVD., DEPT. 1153  
RESEDA, CA 91335

**DX Helper II**  
Macintosh Software W7HR

MUF Map • MUF Pict  
Gray Line • Great Circle  
Prefix. Zone. Oblast  
WWW Alert • CW Drill

**\$49.95** Info  
ppd \$1

**Antennas West**  
Box 50062-E, Provo, UT 84606  
1-800-926-7373 See band openings on the map before they happen!

## INSIDE THE WORLD OF SATELLITE COMMUNICATIONS

### Mission Control – Kaliningrad

The Kaliningrad control center, just outside Moscow, is the Soviet counterpart to the Johnson Space Center. The space center at Kaliningrad consists of three control rooms. The newest was opened in 1988. It is used for the flights of Buran, the Soviet space shuttle. A second controls all MIR/Soyuz missions. The third is used for Progress supply ships.

In a report to the Office of Technology, Dr. Balayan, Vice Chairman of Intercomcos, gave the following description of the flight control center: "The flight control center is equipped with a computer for collection, processing and display of information; crew communications and television; remote command; crew communications and transmission of telegraph messages with Mir. The control center is in communications with the Moscow television technical center at Ostankino. There are 20 telephone and telegraph communications channels between the center and each tracking station.

Each control room contains the shift flight leader, specialists responsible for onboard systems, persons responsible for crew communications, computer, medical and ballistic experts.

Since the flight control center, tracking stations and communications equipment are all the same for each spacecraft, Mir, Soyuz, and Progress, use of the equipment is assigned by priority, (manned missions, of course, have top priority).

Control of the spacecraft is transferred to the control center from the launch site immediately after separation of the last stage of the rocket. Up to this point the personnel in the control room monitor the operation of the onboard systems by telemetry, observe the crew by TV and listen to crew conversations. A central screen shows the course of the rocket over the entire insertion trajectory. After separation, control center personnel monitor the opening of the antennas by telemetry and make contact with the crew.

When the spacecraft enters the zone of visibility of a ground station, commands are transmitted to the spacecraft in accordance with the flight program. The personnel in the control room monitor the transmissions of commands and their reception by the spacecraft. The tracking stations transmit to the control center the TLM, trajectory information, crew communications and television they receive from the spacecraft. Communications operators carry on planned radio conversations with the crew. The 'Zarya' radiotelephone communications system

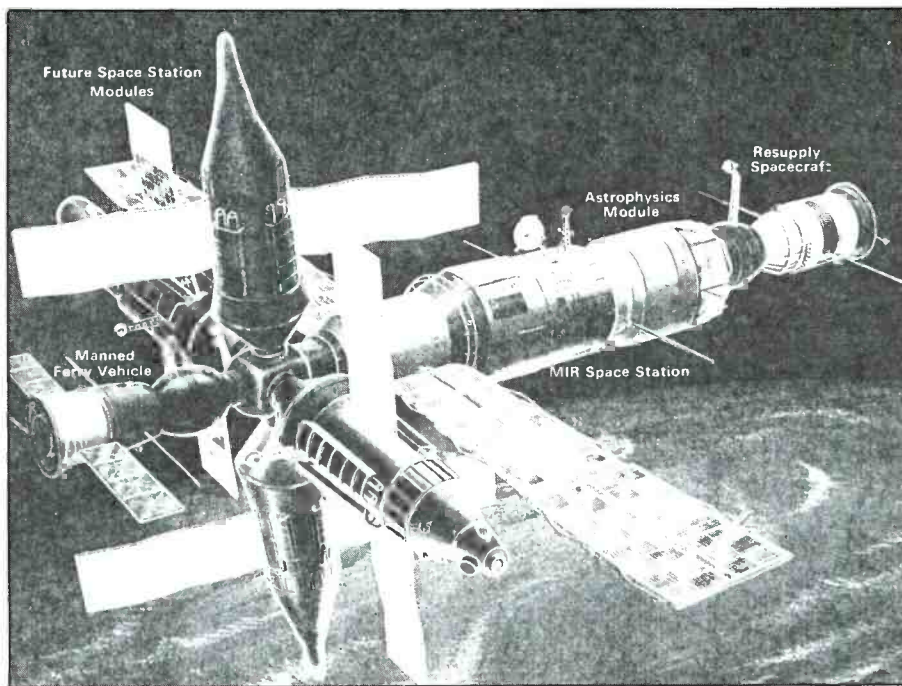

use ultra-shortwave (USW) and (SW) bands. The transmission of text (alphanumeric) information from Earth to the station is sent (encrypted) to hard copy printers."

The Kaliningrad control center is supported by a network of seven ground stations (in the USSR) and a fleet of shipboard tracking stations. Eleven tracking ships are operated by the Institute of Space Research (IKI). IKI is a branch of the USSR Academy of Science. These ships are staged in critical areas to provide communications relay when Soviet spacecraft are out of range of other ground stations or satellites.

Data, TV, TLM and voice communications from Soviet spacecraft are routed to Kaliningrad through two satellite systems. The newest is the Satellite Data Relay Network (SDRN). This is a series of three transponders which use the 14/11 GHz bands. They are known as Luch transponders and are carried by Gorizont geo-stationary satellites. Three such satellites are planned, one is already in orbit. When Soviet spacecraft are out of range of SDRN and Moscow, they relay their communications through a ship station which uplinks a signal to one of the Molniya satellites. Molniya's operate in the 1GHz/800 MHz range. Low priority voice communications from Mir and Soyuz are downlinked to ground stations and ships on 143.625 and 121.750 MHz.

The ships of the IKI network use HF marine bands to communicate with each other

#### IKI CW/RTTY NETS

| Time     | Freq         |
|----------|--------------|
| 0305 UTC | 8.418 MHz    |
| 0905 "   | 12.627 "     |
| 1550 "   | 16.837 "     |
| 2205 "   | 8.418/16.837 |

#### IKI Ground Stations

| Call    | Location       |
|---------|----------------|
| UAT     | Moscow         |
| CLJ     | Havana         |
| URD     | Leningrad      |
| UFB     | Odessa         |
| CMU-967 | Santiago, Cuba |

#### Soviet Tracking Ships

| Callsign | Ship              |
|----------|-------------------|
| UISZ     | A.K. Korolev      |
| UIVZ     | K.V. Volkov       |
| UUVO     | K.V. Komarov      |
| UZZV     | K.G. Dobrovolskiy |
| UUYZ     | Nevel             |
| UUYG     | Morzhovets        |
| UVAU     | Borovich          |
| UKBH     | Kegostov          |
| UKFI     | K.Y. Gagarin      |
| UZYY     | K.V. Patsayev     |

#### Soviet Tracking Stations

|                |                  |
|----------------|------------------|
| 1. Dzhusaly    | 5. Kolpashevo    |
| 2. Yevpatoriya | 6. Tbilisi       |
| 3. Ussurisk    | 7. Petropavlovsk |
| 4. Ulan-Ude    |                  |



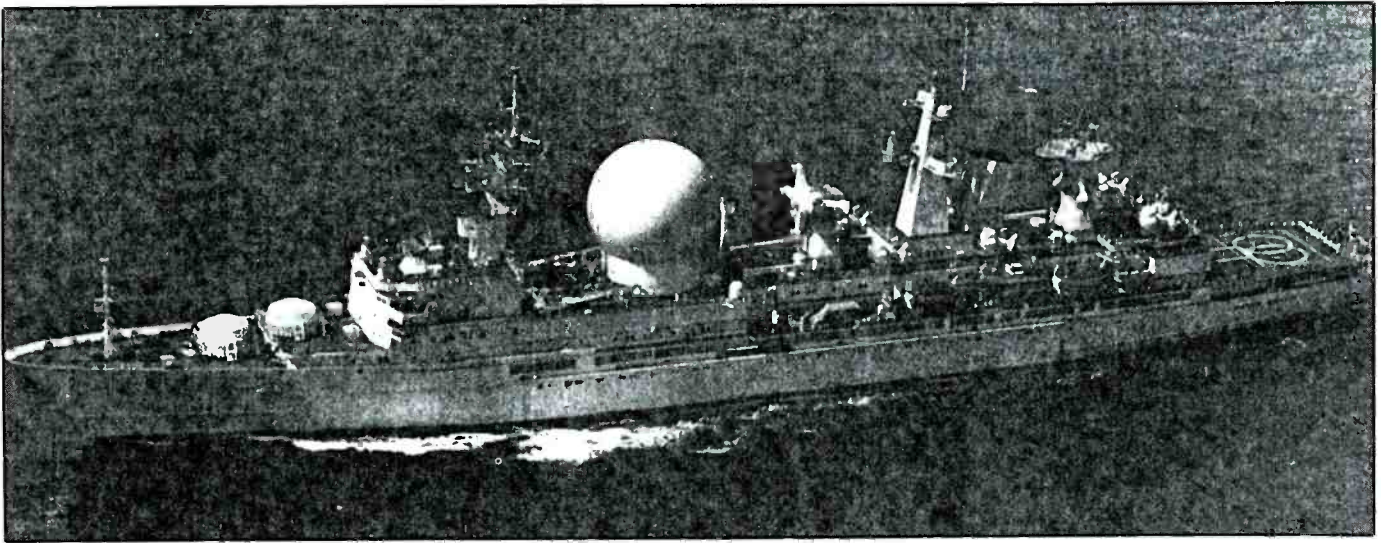

Soviet tracking ship (USAF).

in CW and RTTY. Each day these ships check-in to nets to relay news items, orbital data and encrypted messages known as kriptogrammas. The nets use 50 band with a 170 Hz shift.

Before we take a detailed look at the IKI RTTY nets and orbital data they can provide, I want to introduce you to Sam Ricks, of Philadelphia, PA. Sam is a fellow satellite sleuth. He and a friend, Tom Roach, of San Jose, CA., have spent many weeks and months tracking the ships of IKI and translating the orbital data they intercept into useful information. As Sam is willing to share this research with us, I'll let him explain some of the fine points in his own words.

"Soviet tracking ships can be monitored daily on 3 CW nets. This allows ships in the North Atlantic to coordinate RTTY traffic with tracking ships in the South Atlantic. The ships exchange tracking data, such as, 'look-up' angles, which as you know, plot azimuth, altitude and times specific spacecraft cross the horizon of a ground observer. This allows the ships to aim their radar arrays and telemetry dishes. The following is an example of 'look-up' angles:

| (A)   | (B)    | (C)    |      |      |     |
|-------|--------|--------|------|------|-----|
| W7393 | 3113JG | 3558ZD |      |      |     |
| 2222  | 0052   | 2602   | 1989 | 0000 | (D) |
| 2621  | 2254   | 2194   | 3404 | 0000 | (E) |
| 2300  | 2157   | 3407   | 0003 |      | (F) |

A = orbit number. W7393 is orbit number 17393.

B = Ship's latitude. 3113JG is latitude 31 degrees 13 minutes South.

C = Ships longitude. 3558ZD is longitude 35 degrees 58 minutes West.

D = Date: Column 3 and 4 '2602 1989' reads Feb. 26, 1989.

E = Signal acquisition: 2621 2254 is Feb. 26, 21 hrs 22 min 54 sec. (Moscow time UTC + 3 hrs)

F = 2300 is 23 minutes 00 sec.

2157 is slant angle in km.

3407 is 340.7 degrees Azimuth.

003 is 0.3 degrees altitude.

The shorthand method by which tracking information is encoded and decoded, is similar to how aviation weather data is transmitted, by using the QWERTY system. The top row of letters on a computer or RTTY keyboard is substituted for the adjacent row of numbers for transmitting data. This eliminates the need to continually upshift to figures after each group of numbers. The numbers can be decoded by substitution, i.e.: QWERTYUIOP = 1234567890.

Once the tracking data is decoded, I use ORBIT, a version of the W3IWI orbital prediction program found in Compuserve's Astroform to identify the spacecraft being tracked. I enter the tracking ships position in latitude and longitude and convert Moscow time to UTC for a specific orbit of Mir. Orbit produces almost identical columns of data

showing Mir's pass over the tracking station. By entering the ships location and the orbital elements of known Soviet spacecraft into a satellite tracking program, you can produce nearly identical tables and identify the satellite being tracked.

When the Soviets relay this data ship to ship, they'll send a table of orbits called a 'zone forecast' detailing 30-50 orbits with the tracking ship's schedule of latitude and longitude positions for each orbit.

The purpose of these tables is to coordinate the vessel's movement with Mir and other spacecraft. Almost all the other scientific data is encrypted. Therefore, you can rely on the tracking ship's movements into and out of certain 'zones' and ports to forecast various events, such as launches. For example, deploying a tracking ship half an

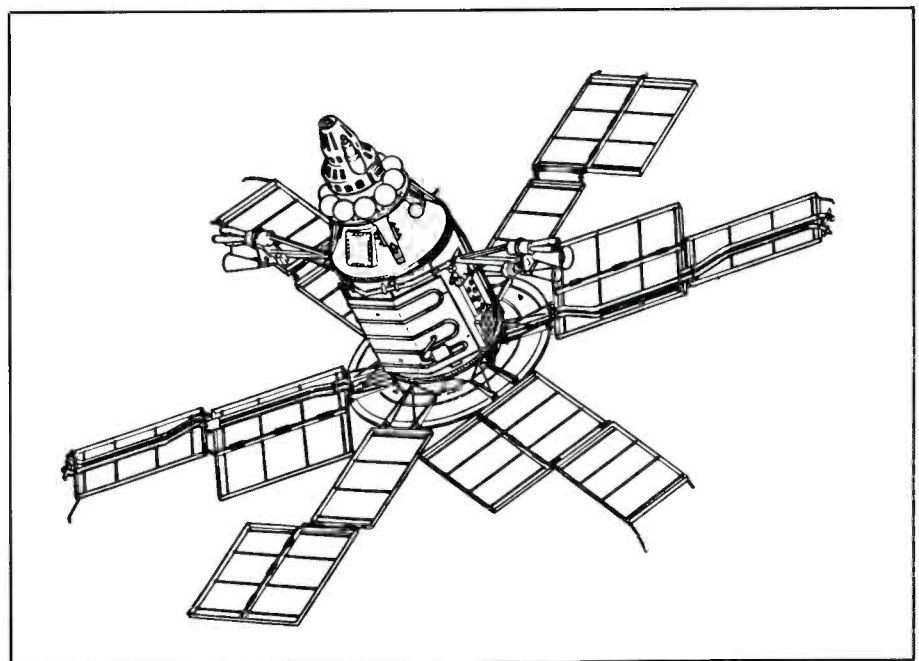

MOLNIYA 3 satellite.

# POPULAR COMMUNICATIONS BOOK SHOP

## World Radio TV Handbook 1990 ed.

The world's only complete directory of international broadcasting and TV stations—the established, authoritative guide endorsed by the world's leading broadcasting organizations. A comprehensive country-by-country listing of short-, medium-, and long-wave stations revised and updated to reflect actual conditions. Also includes special features on The Future Regulation of High-Frequency Broadcasting, Solar Activity in 1985, Technical Innovations at Radio Netherland's New Transmitting Station, and more. 604 pages, paperback, \$19.95. Order #H097.

## Radio Handbook, 22nd ed.

by Bill Orr, W6SAI

A state-of-the-art, single-source reference on radio communications and theory for hams, professional ops, techs, and engineers. New coverage includes solid-state devices, Yagis and quads, and h.f. amplifier designs. A hands-on instruction manual, as well. 1168 pages, hardcover, \$39.95. Order #S197.

## World Press Services Frequencies

by Thomas Harrington

A comprehensive manual covering the field of radioteletype news monitoring—antennas, receivers, terminal units, monitors, and more. Contains 3 master lists of times of transmission, frequencies, plus ITU list of over 50 news services worldwide. 72 pages, paperback, \$8.95. Order #H173.

**Antenna Handbook**, 192 pp. paperback, \$11.95. Order #H145.

## Packet User's Notebook

This brand new book by Buck Rogers, K4ABT is your one source of essential information for the newcomer or oldtimer. Tips, tricks and techniques from a real insider. Over 90 diagrams showing the tried and true connections for popular TNCs, transceivers and computers. Why chance destroying hundreds or thousands of dollars of equipment with risky connections? This is a genuine nuts-and-bolts how-to-do-it manual that every packet operator should have on the bookshelf. Packet is not only the fastest growing segment of amateur radio. It is the fastest changing, too! Why rely on information that may be a year or more out of date what **Packet User's Notebook** is hot off the press with the latest essential information? Don't "connect" without it. It is only **\$9.95**, and that's a small price to pay for peace of mind. Order today.

## Ameco Novice Code and Theory Package

A complete training package containing the 128-page Novice theory course and a 60-minute code cassette, which teaches how to send and receive code up to 8 words per minute, and a 32-page book. Also included are FCC-type code and theory examinations to help even a rank beginner get a ticket fast! \$9.95. Order #H024.

**Cubical Quad Antennas**, 112 pages, paperback, \$9.95. Order #R146.

**Vertical Antennas**, 192 pages, paperback, \$10.95. Order #H303.

**Interference Handbook**, 247 pages, paperback, \$11.95. Order #H172.

## RTTY Today

by Dave Ingram, K4TWJ

A brand new, completely up-to-date handbook on RTTY, covering the latest developments and techniques, plus use of the home computer for RTTY. Illustrated with photos, diagrams, station setups, and RTTY gear. 112 pages, paperback, \$8.95. Order #H211.

## Vertical Antenna Handbook, 2nd ed.

by Paul H. Lee, N6PL

Out of print for several years, this classic has been reprinted with updates, including an addendum on antenna design for 160 meters. Other sections include feeding and matching, short verticals, ground effects, and much more. 139 pages, paperback, \$9.95. Order #H208.

## The Radio Publications Group—The "Bill Orr Series"

These easy reading classics belong in the library of any active ham. Loaded with practical how-to information, with tables, charts, and formulas arranged for handy reference.

**Beam Antenna Handbook**, 200 pages, paperback, \$11.95. Order #H143.

**Wire Antennas**, 192 pp., paperback, \$11.95. Order #H144.

## The Shortwave Propagation Handbook, 2nd ed.

by George Jacobs, W3ASK, and Theodore J. Cohen, N4XX

A new, revised edition of the popular guide to all your propagation needs. Contains up-to-the-minute information and charts, and guides you through producing your own propagation data. 154 pages, paperback, \$9.95. Order #H137.

## Passport To World Band Radio, 1990 ed.

By Radio Database International

A graphically-oriented guide to shortwave stations, listening, radios, and accessories. Now you can tune-in the over 1100 radio stations around the world broadcasting everything from news to authentic Peking opera. Paperback, \$14.95. Order #R400.

## Easy-Up Antennas for Radio Listeners and Hams

By Edward M. Noll

This comprehensive handbook can help you construct low-cost, easy-to-erect antennas. Contains all the latest antenna design and construction tips, techniques, and tools needed, plus info on testing procedures, band frequencies, time considerations, and more. 163 pages, paperback, \$16.95. Order #S401.

orbit down range from Baikonur (south of Easter Island) is an indication of an imminent launch. South of Easter Island is where the orbit is circularized by a short rocket burn. This retrofire position in the South Atlantic is important from a safety standpoint. By monitoring the Soviet tracking ship network I can decode within minutes detailed moving plots of tracking ship positions and their schedules for tracking and communicating with Mir.

Without these tracking ships, Soviet ground stations would be out of touch with Mir for 12-18 hours a day. Generally a tracking ship will monitor Mir for series of orbits over an 8-12 hour period. They pick up Mir again 12-16 hours later as another series of orbits crosses their horizon. They use the periods when Mir is out of range to move to more advantageous positions allowing Mir to remain above the horizon longer.

Callsigns for the Soviet tracking ships were found by monitoring their CW nets and cross-referencing them with the ITU ship station callsign lists. Tom Roach, of San Jose, CA., and I teamed up to monitor these nets and compare loggings.

I found two net frequencies simply by following a tracking ship's instructions to another vessel to change mode and frequency. It took us several months to pinpoint net times. Our net times and frequencies were confirmed when net schedules were relayed to a tracking ship entering the North Atlantic from the English Channel enroute to a location off Togo.

Several weeks prior to the Buran shuttle launch, tracking ship communications increased sharply just after 0305 UTC according to our loggings. Tom Roach and I have been monitoring the Soviets on an almost daily basis since. I have been monitoring the Soviets since May of 1988. Though the Soviets send the data without descriptive headings they are easily recognizable as orbital data. A home computer with word processing software, RTTY/CW software and orbital prediction program can be used to monitor the Soviet space program via shortwave and RTTY modem. I use an old Apple II computer.

Monitoring Soviet tracking ships on HF maritime bands offers the SWL a ring side seat on a somewhat secretive ongoing space mission: i.e., Mir operations from the vantage point of a mid-ocean tracking ship. And there is no need to learn Russian to figure out the tracking data.

Tom Roach and I were curious to find out how much we could learn about the Soviet space program by monitoring their tracking ships. We found that they were a lot less secretive than might be believed."

Thanks for that very interesting briefing on the IKI ships and their CW/RTTY nets, Sam. I am sure your work will be appreciated by other Satellite View regulars.

If you have some special area of research or interest or an interesting intercept why not share the information with your fellow enthusiasts at S.V. . . . See you next month.

# POPULAR COMMUNICATIONS

BOOK SHOP 76 North Broadway, Hicksville, NY 11801

| QTY.                   | ORDER# | TITLE | PRICE | TOTAL |
|------------------------|--------|-------|-------|-------|
|                        |        |       |       |       |
|                        |        |       |       |       |
|                        |        |       |       |       |
| <b>Book Total</b>      |        |       |       |       |
| <b>Shipping Charge</b> |        |       |       |       |
| <b>Grand Total</b>     |        |       |       |       |

Shipping charges \$2.00 per order. Shipping charges waived on orders of \$50.00 or more. Books shipped best way. All orders are processed the day they are received, but please allow 30 days for delivery within North America.

Name \_\_\_\_\_

Address \_\_\_\_\_

City \_\_\_\_\_

State \_\_\_\_\_ Zip \_\_\_\_\_

Check    MasterCard    VISA

Card No. \_\_\_\_\_ Expires \_\_\_\_\_

X \_\_\_\_\_

Signature required on all charge orders

## RADAR DETECTORS AND THEIR USE

### **Association Offers Assistance In Fighting The High Cost Of Massachusetts Fines**

When Massachusetts speeding fines all cost a flat \$50, many drivers simply mailed in their payment whether they were guilty or not. But now that fines can range into hundreds of dollars, a motorists' rights group encourages drivers to challenge tickets they did not deserve.

"One of the biggest hoaxes put over on the motoring public is the accuracy of police traffic radar," commented Janice Lee of the Radio Association Defending Airwave Rights, Inc. Once you know about the weaknesses of radar, it's not surprising that some experts estimate as many as 20 percent of all radar-backed speeding tickets are written in error."

Lee noted that road signs, a police cruiser's defroster fan and radio transmissions can all produce erroneous readings, and that inexperienced operators often are fooled by such readings.

She also pointed out that the enormous increase in the fine schedule—including the \$700 ticket issued to one driver—raises the possibility that revenue generation will be the motivation behind enforcement. In fact, the Associated Press recently quoted one court official as saying, "We're tax collectors now. We're the tax collectors, and the police are the assessors."

RADAR, a nonprofit national membership organization, offers two aids to drivers who want to fight bad tickets:

—"Beating the Radar Rap", by Road and Track contributing editor John Tomerlin and Fuzzbuster radar detector inventor Dale T. Smith, is a book that describes how radar mistakes are made and offers drivers a strategy for defending themselves against undeserved citations.

—"Radar on Trial" is a videotape that provides a visual glimpse at many of the same issues as "Beating the Radar Rap", including a valuable segment on courtroom procedure.

Details on the book and video, as well as additional information on traffic radar errors and legal defenses, are available from RADAR at 4949 S. 25A, Tipp City, OH 45371.

### **Anti-Detector Bills Still Active In Four States**

Of the 13 state legislatures that considered radar detector bans in their 1988 sessions, only four still had active anti-detector bills before them by summertime. The

group includes Massachusetts, Michigan, New Jersey and New York.

What follows is a state-by-state look at this legislation.

**Massachusetts** - Of three House bills introduced in January, none made it out of committee. However, in mid-June Rep. Bill Constantino was able to add a detector ban as an amendment to House Bill 5858, a piece of legislation dealing with insurance. He also was able to add a similar amendment to House Bill 6005, a piece of legislation dealing with taxation. The amendment on the taxation bill was removed and signed by the governor, however, the automobile insurance bill could be acted upon in 1988. RADAR is working to make sure those amendments do not become law.

**Michigan** - Apparently last year's radar detector fiasco was not enough for some Michigan lawmakers, because Sen. Doug Cruce in late March introduced SB786. The bill, now before the Senate State Affairs and Tourism Committee, would prohibit use of a radar detector and allow police to confiscate the devices.

**New Jersey** - Senator Catherine Costa's SB329 would outlaw use or possession of radar detectors in commercial vehicles. Introduced in January, the measure has not moved from the Senate Transportation Committee.

**New York** - While other states consider a bill or two on any given issue, New York lawmakers generally offer a half-dozen or more proposals. With radar detectors it's no different: The legislature has before it four measures banning radar detectors in heavy trucks or other commercial vehicles (SB431, AB5139, SB2297B, and SB8912), and four bills outlawing detectors altogether (AB2099, AB8744, AB5732, and SB1257). Except for AB2297B, AB8744, and SB8912, New York's anti-detector bills all were carried over from the 1987 session.

As always, RADAR members interested in more information about any of these bills, or anyone who wants to assist with the association's legislative efforts, should contact the association office. Likewise, if you learn of any new anti-detector legislation in your state, please call RADAR as soon as possible.

### **Geico Leads The Way In Forming Anti-Detector Organization**

In an attempt to give its discriminatory anti-detector policy the appearance of having public backing, GEICO Corp. has formed an organization calling itself GUARD - Group United Against Radar Detectors.

In addition to the insurance company, the

coalition also includes the International Association of Chiefs of Police, the American Driver and Traffic Safety Education Association, the National Association of Independent Insurers and the National Safety Council.

Last year, RADAR initiated action against GEICO in Maryland for refusing to insure drivers who own radar detectors. While state insurance officials ruled against GEICO in March 1988, the insurer appealed the decision to the Baltimore Circuit Court. A judge granted the insurer's request that the insurance commissioner's ruling be stayed until the issue is decided in court.

Announcing the formation of GUARD in late June, GEICO officials trotted out the same tired claims against radar detectors.

"There's only one reason to use a radar detector," said GEICO Vice President August Alegi. "That's to break the law without getting caught. But eventually the odds catch up with speeders and they're involved in accidents. All Americans pay for those accidents in the form of lost lives, debilitating injuries, property damage, higher auto insurance premiums and increased tax support for public assistance programs for those who are injured but have no insurance."

RADAR immediately responded to the announcement of the new organization, calling its efforts misdirected.

We are disappointed to see groups with the resources of these using their time and money to continue a battle they have lost consistently for the past 25 years. These same resources could be used to promote policies that will genuinely improve highway safety.

Since 1979, 33 state legislatures have rejected 110 radar detector bans. No state has banned detectors since 1962.

Despite GEICO's pronouncements, there is no evidence that detectors cause higher speeds, much less cause accidents. In fact, when unmanned radar was beamed along sections of an interstate highway in Kentucky, the result was a slight but significant reduction in speeds. Studies in Texas, Maryland and Virginia have produced the same results—all clearly indicate that radar detectors cause the same effect on drivers as spotting a patrol car. Moreover, RADAR has shown that detector owners as a group are safer-than-average drivers.

GEICO officials realize that to drum up support for GUARD's aims, they must appeal to public opinion. To do so, they are couching their arguments not only in terms of safety (which is difficult at a time when the highway fatality rate is the best ever) but they also are taking aim at the consumer's pocketbook. The reckless actions of detec-

tor owners, they say, result in higher insurance rates, and consumers are being "ripped off" by the manufacturers of what GEICO sees as soon-to-be obsolete radar detectors.

"GUARD is asking the public to take steps to get radar detectors banned, including writing to state and congressional representatives, refusing to buy the devices and discontinuing the use of radar detectors they may own now," the organization said in a press release.

RADAR will be vigorously opposing the actions of this new group.

### **"Undetectable" Radar: Off-Frequency And The Ka Band**

You are motoring down the road, when suddenly there's a bright red light in your rearview mirror. On the speeding citation, the officer indicates he nabbed you with radar. But your radar detector, which had been working fine, never made a peep.

RADAR has been hearing similar stories

more and more frequently, though most of the incidents are related on a second- or third-hand basis. Sometimes the "undetectable" radar turns out to be a VASCAR unit; sometimes the blame is placed on radar operating on one of two most recently approved bands; other times it is suspected that police are tuning their units slightly off permitted frequencies.

In the first case, VASCAR, the answer is easy. But what about the new radar bands and detuning—are they something drivers should be concerned about?

The Federal Communications Commission has approved four frequencies for traffic radar. The 10- and 24-gigahertz bands are known as X and K, respectively. The two newest bands are in the 13 and 34 GHz range, and the latter is known as Ka band.

Despite plenty of rumors to the contrary, Ka is used only by the handful of photo radar units operating across the nation. The 13-GHz band also was approved for use by photo radar, but RADAR doesn't believe anyone is operating on that frequency.

This specific type of radar operates under low power with a very narrow beam shooting more across the road than down it. One of the best means of defense against this type of radar is to keep a suspicious eye on vehicles parked along the road in areas where it's in use. RADAR members should be well aware of the associations criticisms of photo radar procedure.

Detuning radar, or operating it off-frequency, is a practice that concerns RADAR greatly, but we have difficulty determining whether it is a widespread practice. We have heard that at least one radar manufacturer has advised clients to tune their units off-frequency to thwart radar detector users. Apparently, the adjustment can be made fairly easily with a screwdriver. It is believed that evidence gathered with a radar unit operating outside an FCC-approved band would be inadmissible.

We would very much like to hear from drivers ticketed by an officer using "undetectable" radar, especially if there is reason to believe the radar unit was operating outside its proper frequency. Keep your eyes and ears open.

### **Beaming In** (from page 4)

over, I learned more about agriculture than I thought there was to know by tuning in WLQM (1580 kHz), Franklin, VA. And right in the middle of bluegrass, Slim Whitman, the porkbelly prices, I was even treated to a program in one of the most exotic languages recently heard. I eventually learned it was Slovenian being broadcast by WBCW (1530 kHz), Jeanette, PA.

In all, it was a rich and varied quilt of fantastic products that I never new existed, wonderful local dialects, hometown news items, homey air personalities, and music that doesn't make the playlists of very many stations in my normal earshot.

What a perfect soundtrack to accompany the widescreen, 3-D panoply of images flashing before me in the private screening room of my car.

If you normally take long trips with CB, ham radios, or scanners going, or with a CD or tape deck filling the car with music, you might just be missing out on much of the enjoyment of your trip. Next time, even if just for a little while, try flipping on the car radio and experience the feeling of running the correct audio that matches up with all of the visual images being shown on your screen.

It's a totally different way of appreciating the beauty of a drive through America. **PC**

### **Photo Radar Heads North**

The concept of photo radar is beginning to catch on in Canada, with an interesting twist or two.

According to one report, four Canadian cities are testing the Swedish Multanova camera radar system, and in Victoria, British Columbia, an insurance company is picking up the cost of using the system.

As in the United States, citations are sent to the owner of a vehicle caught speeding on film. If someone else was driving, however, it's the owner's responsibility in Canada to collect the fine.

### **Council Member's Ticket Dismissed Due To Faulty Radar**

In North Ridgeville, Ohio, a city council member was stopped for speeding, but no citation was ever issued. A local newspaper smelled scandal, but all it uncovered was a bad radar reading and good police procedure.

Council Member Roseanne Johnson was stopped and accused of traveling 57 mph in a 35-mph zone. Johnson, who uses a radar detector, complained to the officer she wasn't driving that fast. Checking the reading, the patrolman discovered she was right, and he turned the ticket into his chief without issuing it.

The nearby Lorain Journal, however, got wind of the ticket fixing and talked the mayor's office into investigating the matter. But all the investigation turned up was an admission from the chief that radar is "far from infallible" and a commendation from the town's safety service director that the incident involving the bad tickety was "handled well and professionally done." **PC**

### **Ham Column** (from page 48)

turf for space-restricted amateurs. At these frequencies, antennas are physically quite small. Putting up a small Yagi antenna is not out of the question. When I was getting acquainted with 440 MHz FM, I simply aimed a small beam out my third-floor window. I hit several area repeaters with no trouble, and had many simplex QSO's, too. Besides, in many metropolitan areas, the rubber-duckie antenna on a VHF handheld will be more than enough to access several local machines. Here, indoor antennas may be no sacrifice at all!

The same goes for packet radio. With the number of digipeaters and packet radio nodes on the increase, apartment-dwelling hams can converse with and leave messages for other hams locally and across the

country—and check into a growing number of packet BBS systems nationwide.

So don't give up on ham radio just because you lack the real estate for conventional antennas. There's lots of fun to be had with indoor alternatives. Remember, practice and experimentation make perfect. . . .

### **Reading Material**

The following books, available from the ARRL, will shed additional light on your search for restricted-space and indoor antennas, and antenna basics: *Novice Antenna Notebook*, *The ARRL Handbook*, *The ARRL Antenna Book*, and *WIFB's help For New Hams*. For more information, drop me a line at: ARRL, Department PCN, 225 Main Street, Newington, CT 06111. **PC**

## 27 MHz COMMUNICATIONS ACTIVITIES

**R**emember the days when most CB rigs were the size of VW Beetles, and when you installed them in the mobile unit they took up most of the middle of the underside of the dashboard? That was then, this is now. The new Midland International Model 77-094 is a full-featured mobile AM transceiver that measures a hair larger than 4" wide, by 1" high, by 6" deep. I've had sandwiches for lunch that are bigger than this rig, yet it does everything and kicks out full power!

Despite its pint size, it actually offers some rather advanced features. Its got a full-time ANL to whack-out unwanted noises; it also offers ETR electronic frequency tuning to provide pinpoint channel selection by means of separate up/down controls. The MHz inhaler is dual-conversion, which provides suitable selectivity thanks to a ceramic filter.

In addition, the Midland 77-094 features a large, high-intensity green LED channel readout, separate LED systems for transmit and receive, and a mike with a front panel locking mount. The set has quick-disconnect mounts. An external speaker jack allows for the addition of speaker accessories.

Forget plastic, this is in a rugged metal cabinet finished in black. For more information of the Midland 77-094, contact Midland International Corp., Consumer Communications Division, 1690 N. Topping, Kansas City, MO 64120, or circle 101 on our Reader's Service.

### You Wrote To Say

Mike Yohnicki, of London, Ontario advises than, as of this past April 1, it is no longer necessary to have a General Radio Service (CB) license in Canada. Mike received this flash from the Department of Communications when he tried to renew his license.

"Help," says Ed Carroll, adding, "I was given a Midland 77-838 and have been searching for a microphone for the set. The mike has a 12-pin jack and (according to Midland) most of the controls are located on the mike." Can anybody point Ed in the general direction of a new or used mike for this CB rig? Contact him at: Ed Carroll, P.O. Box 193, Morganfield, KY 42437-0193. This rig dates from 1977, so it's not going to be easy locating this component, which is the heart of the set.

A note from Duane Frantzick, box 411, Ray, ND 58849 advises that in Williston, ND the place to meet the local CB crowd is at the Dakota Farms Restaurant, where the coffee is hot, strong, and a good accompaniment to the chatter on Channel 19. Duane monitors that channel (handle: *Rampage*), too and says that any CB'ers passing



Midland's new 77-094 packs a lot into a small package.

## Cactus Kid

KCX-2113

DAVID ANDERSON  
1265 W. Lancaster Blvd.  
Lancaster, CA 93534

ALL 23 CH.      MONITOR 15-17-19

The Cactus Kid sent this nifty card from Lancaster, CA.

through are invited to give him a shout.

A very friendly sort is old timer George Wight, SSB Network member SSB-0A116 (also Registered Monitor KCA6HL), of P.O. Box 732 Groveland, CA 95321. George and his family (XYL Judy, harmonic Randy) are located on Highway 120 about 50 miles east of Yosemite National Park at 3,800 ft. elevation. That's in picturesque Tolumne County. If you're passing through on the way to Yosemite, give George (*The Tea Base*) a shout on AM Channel 18, or as SSB-0A116 on the lower side of 16, 35, or 40. If you're not 4-wheeling in his area, send him your QSL!

Another QSL fan is Ryan Lughermo,

This is to certify that radio communications were established between your station and

**29 ROMEO PAPA 1104**  
RADIO PIRAT REP. OF IRELAND



Op. FRANK  
P.O. BOX 27  
CORK  
REP. OF IRELAND

printed by radio pirat dx group

This QSL from the Republic of Ireland is printed in bright green.

P.O. Box 413, Midland, MI 48640-0413, who may be better known on the channels as *Night Ranger* and Central Michigan 1337. Ryan has some new QSL's coming from the printer and would like to exchange them with other operators.

Fred A. Nicholas, of Long Beach, CA writes to tell us about the team of armed robbers who knocked over three Downey, CA banks in a 90-minute period. At the third bank, a customer using the outside automatic teller machine was bumped into by one of the suspects. The customer noticed that the guy was in a big hurry and was wearing a gun. The bank customer got into his car and watched where the other fellow's car was heading; he also called his wife on the CB and told her to contact the Los Angeles County Sheriff's Department. Via radio, the CB'er and his XYL, relayed information to sheriff's deputies in order for them to head off the bandits. It ended up with the sheriff's deputies cornering the suspects in an alley and engaging in a shootout. The two suspects (one was a woman) were seriously wounded. They were carrying a .25-caliber automatic. A satchel containing thousands of dollars was also found in their vehicle. The CB'er who directed the deputies was not identified.

Jim, SSB Network member SSB-584C, comments on the photo of *The Bozo* we ran in the February issue. He notes that the Bozo group began as a local AM club but eventually began taking members from across the nation. Jim started it as sort of a joke, but it has turned out to be a rather large

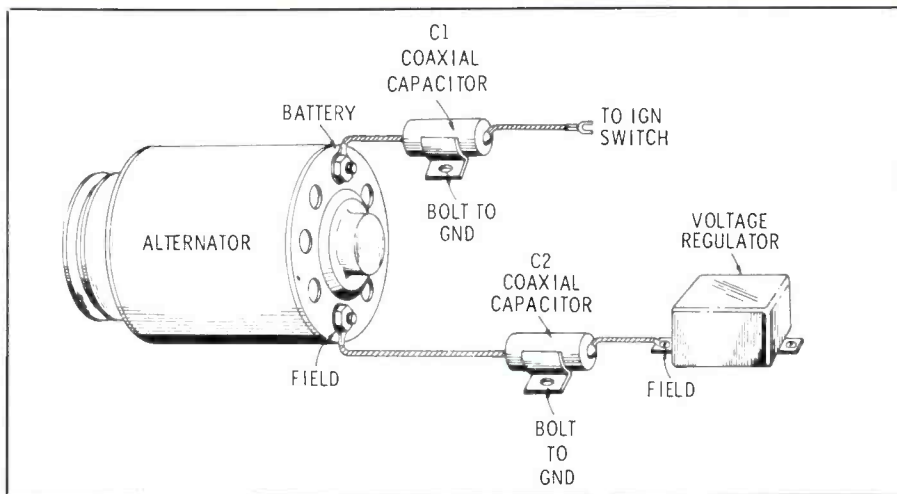

Fig. 1. Alternator Filter.

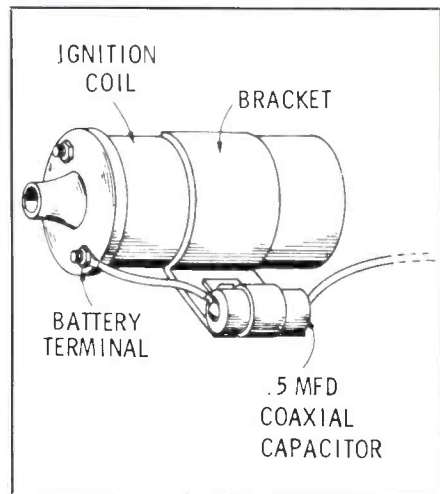

Fig. 2. Eliminating Ignition-Coil noise.

group, now known as AMR QSL Club, 4490 Clairmont Dr., San Diego, CA 92117.

Our overseas QSL of the month for August comes from 20-RP-1104 in the Republic of Ireland, via Frank, SSB Network member SSB-35F, of the Lone Star State. The Romeo Papa ("Radio Pirate") group is headquartered in Belgium.

### Stop That Racket

How about all of that electrical noise in your CB mobile rig? Let's tackle that this month so you can take your vacation with as little snap, crackle, and pop as possible.

In the mid 1960's there was a gradual changeover from the generator to alternator in auto ignition systems. Not only does an alternator charge the battery at engine idling speeds, but it reduces the amount of noise picked up by the CB transceiver. Yet there

are occasional cases where filtering of the alternator can produce quieter reception.

Shown in Fig. 1 are two points in the system which may be bypassed with high-quality coaxial capacitors. These capacitors (such as Sprague 48P18) are rated at a capacity of 0.5 mfd and current handling of 40 amperes. They operate by short-circuiting the offending noise to ground, while leaving DC power from the alternator unaffected. The mounting tab on capacitor C1 is bolted to the frame of the alternator. For a good electrical ground, the tab must contact a clean, oil-free surface.

Depending on the particular car, one or both capacitors are required. This can be checked by installing each capacitor and noting its effect on noise pickup in the receiver. Capacitor C1 can be installed at the alternator's output lead, which may be

marked "Batt" (for battery). The lead is cut and connected to the end screws of the capacitor. The other capacitor, C2, may be connected at the voltage regulator's F, or field, terminal.

An additional step can help to further reduce alternator noise at the source. Cases of noise have been traced to dirty slip rings and worn brushes. Although these components produce less sparking than the brush-and-armature arrangement in the conventional car generator, they can still produce enough interference to receiving range.

Whenever an alternator-equipped car is given an ignition tune-up—or at approximately 10,000-mile intervals—serviceman should remove the alternator and open its housing. This permits cleaning of the two slip-ring surfaces. At the same time, brush length and spring tension should be checked. Some alternator manufacturers recommend that when brushes are worn down to one-half of their original length, replacement is advisable. Each of the items can produce sparking and the radiation of noise.

Another factor is an out-of-round condition of the slip rings in older alternators. Even a small error, as little as 0.0005 inch, may upset normal alternator operation, and possible increase noise level. This, too, can be determined when the alternator is removed for inspection.

### Ignition-Coil Noise

There is a possibility that noise energy at the car's ignition coil may find its way into the lead which brings battery power to the coil. By confining the noise to the coil, there is less chance of interference of this type is characterized by a popping noise heard in the CB set while the engine is operating. It varies with engine speed.

The method for reducing coil noise is by bypassing it with a coaxial capacitor. Use a 0.5-mfd unit and install as shown in Fig. 2.

since-1975

The TEA Base Tuolumne County

AM/LSB/USB

**KSY-3723**

**U  
S  
A**

George, Judy & Randy Wight  
P.O. Box 732  
Groveland, Calif. 95321

TeaBerry, TeddyBear & TeaTrucker

If you're in California's beautiful high country, say hello to George, Judy and Randy. This is their colorful QSL card from Groveland, CA.

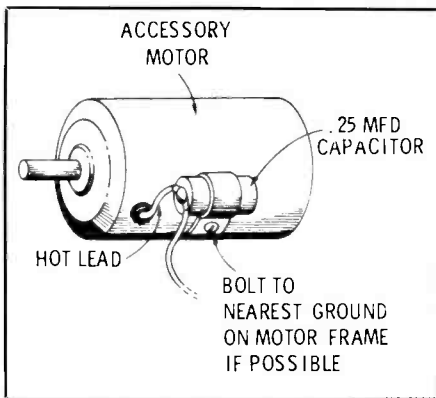

Fig. 3. Eliminating accessory-motor noise.

The capacitor must mount as close as possible to the coil terminals. A bolt on the coil mounting bracket may prove practical. Wiring the capacitor is done by removing the lead going to the coil's battery terminal, and connecting it to one end of the capacitor. A short, heavy wire is then installed between the other end of the capacitor and coil battery terminal.

### Gauge Interference

After the noise from the car's ignition system is suppressed, there may be a noticed electrical interference from other sources. A typical source is the various gauges which create sparking at their operating elements and consequent radio noise. Since these instruments, for gas, oil, and temperature, operate intermittently, the noise they create is neither constant nor in step with engine and road speed.

A technique for locating a noise gauge is to listen while the noise occurs, then disconnect the "hot" wire at the rear of the gauge. This should be done to one instrument at a time, so that the troublesome unit can be pinpointed.

Treatment for the noise is accomplished by installing a 0.1-mfd coaxial capacitor at the rear of the gauge, keeping the lead from gauge terminal to capacitor as short as possible. The metal mounting lip of the capacitor must make a tight, clean connection to the metal of the dashboard or other electrical ground.

### Accessory Noise

Electric motors which are used to operate various accessories in an automobile may occasionally give rise to CB interference. Usually the motors have carbon brushes which produce sparking that either radiates interference via the air or impresses it onto wiring which is ultimately connected to the transceiver. Among these accessories are the windshield-wiper motor, heater fan, and blower motor. Simply turning the accessory on and off while the transceiver operates will determine if it is causing noise.

Minimizing the interference is done by

providing a suitable bypass capacitor at the hot power lead that supplies the accessory. This is done, as illustrated in Fig. 3, with a high-quality, single-ended capacitor rated at 0.25 mfd. It is mounted close to where the power lead emerges from the accessory. For maximum effectiveness, the body of the accessory should be well-grounded to the car frame with a short, heavy piece of shielded braid.

### Spark-Plug Noise Suppression

This is the most common type of interference and frequently the strongest. It is caused by high-voltage sparks jumping across the gap of spark plugs and inside the distributor. The car should be equipped with at least one of the various techniques available for suppression. Identifying spark interference is done by turning off the engine, then turning the ignition key to the accessory position, and listening to the CB transceiver. The ignition noise should disappear. When the engine is running, the speed of the popping noise keeps in step with engine rpm.

Before taking corrective measures, see if the car is already equipped with spark-noise suppression. This is done by examining the

cables which run from each spark plug to the distributor. If they are marked with words like "radio resistance," this indicates that suppression measures are present (true for many late-model autos). Older cars can often be equipped with this special high-voltage resistance cable. Be sure to obtain a cable set intended for your car.

Another approach is the use of special resistor-type spark plugs. These units have built-in suppressor resistors. These are also available as separate units which plug into the top of each spark plug and into the center hole of the distributor cap.

Be sure that all high-voltage cabling is in good condition. Small cracks in the insulation are apt to cause electrical leakage and noise.

The most elaborate form of plug and distributor suppression is complete shielding. Although this is intended primarily for marine installations (since a wood or fiberglass hull provides no shielding effect), there are kits available for automobile ignition systems. In most instances, however, ample noise reduction is possible with the simpler techniques mentioned earlier.

This column seeks your CB QSL's, station photos, comments, questions, newspaper clippings, and ideas. We want to be your source of CB information, your input is needed and appreciated!

## CB Thoroughbreds with winning credentials.

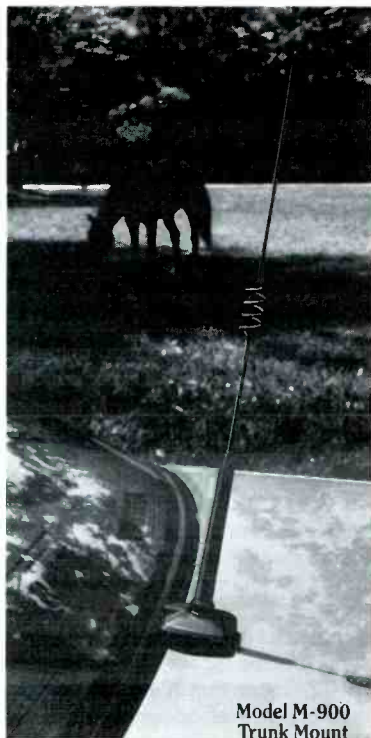

Model M-900 Trunk Mount

the **AS** Black Stallions™

Sleek and spirited, the new A/S Black Stallion™ CB antennas have an unfair advantage over all other brands—the long, proud heritage of the most respected name in professional communication antennas. With the finest 17-7PH stainless steel whips, high-tech protective black DURA-COAT™ finish, and contemporary styling, these exceptional antennas have no peers for strength and beauty.

Now's the time to catch a Black Stallion for yourself. Send for your free 16-page "CB/Monitor Antennas" booklet today.



Model M-902 Trunk Mount



Model M-904 Magnet Mount



Model M-906 On-Glass®

the antenna specialists co.

A member of The Allen Group Inc.

30500 Bruce Industrial Parkway • Cleveland, OH 44139-3996 • 216/349-8400

© 1988 by The Antenna Specialists Co.



Stripes of Quality

CIRCLE 56 ON READER SERVICE CARD

# WASHINGTON PULSE

## FCC ACTIONS AFFECTING COMMUNICATIONS

### **Rules Regarding Operation Of Radio Frequency Devices**

The Commission has granted, in part, requests by Control Data Canada, Ltd. (CDC) and Hewlett-Packard Company Medical Products Group (HP) for reconsideration and clarification of its Order revising Part 15 of the rules regarding the operation of radio frequency devices without an individual license.

In adopting the new rules on March 30, 1990, the Commission recognized the intensive use that future High Definition Television broadcasts may place on the bands allocated to television broadcast stations. Consequently, the Commission prohibited new types of Part 15 devices from access to this spectrum, but allowed such devices that were permitted under the former rules to continue operation.

CDC is a manufacturer of perimeter protection systems operating under Part 15 in the bands 54-72 MHz and 76-88 MHz. HP manufactures transmission systems used to relay biomedical telemetry data. Seeking reconsideration, both CDC and HP requested limited exceptions to the prohibition on new types of non-licensed operation in the television bands.

Specifically, CDC requested that the Commission: 1) Permit perimeter protection systems operated on television channels 2-6 to be used in residential applications when the residence is an "estate," defined by CDC as residences of two or more acres; and, 2) provide delegated authority to FCC staff to exempt particular systems, upon a sufficient presentation of data, from the requirement to test at each installation. CDC also requested clarification of the rules pertaining to multiple transmitters and transmission lines.

HP asked that the Commission permit the operation of biomedical telemetry transmitters on additional frequencies in the television bands and allow its new electrocardiogram digital monitors to operate within the frequency band 512-566 MHz. In addition, HP requested clarification as to whether existing devices operating in the 174-216 MHz band could be replaced by a new model possessing some level of enhanced performance, or if the prohibition precludes the introduction of these new devices.

Although the Commission declined to permit perimeter protection systems operating in the television bands to be used on residential estates, or to provide delegated authority to FCC staff, it will permit biomedical telemetry devices to operate in the television bands. The prohibition against opera-

tion in the television broadcast bands was applied to all new categories of Part 15 devices because of the Commission's inability to control the location of these devices. However, biomedical telemetry devices are unique devices that are used for such limited applications that their operation can easily be confined to specific locations. HP's equipment would be confined to hospital buildings, where sufficient shielding is provided to attenuate the emissions of these devices to levels where interference to television reception would be unlikely.

### **Michigan Men Fined \$1,000 Each For Unlicensed Radio Operation**

Larry Robinson of Sheridan, Michigan, and Gary Roberson of Alma, Michigan, were fined \$1,000 each for the unlicensed and unauthorized operation of a radio transmitter. They were illegally operating on 156.25 MHz which is assigned to the Maritime Radio Service. During the past several months, investigators from the Allegan, Michigan Office, using mobile-direction-finding equipment, traced the illegal transmissions to the Robersons' home.

### **Miami Pirate Shut-Down**

The FCC's Field Operation Bureau, in a coordinated effort with its monitoring network and engineers from the Miami Office, shut down a Florida pirate broadcast station. Eloy Escagedo of Miami, Florida was fined \$1,000 for illegally operating on 7350 kHz. Escagedo's station was used to transmit commentary and music. He identified the station as Radio Antorcha Martiana. Escagedo had previously been shut down in 1982 for operating another unlicensed station.

### **Illegal CB Equipment Seized**

Engineers from the FCC's San Francisco Office and the U.S. Marshal's Service executed a civil *in rem* seizure of illegal radio equipment valued at approximately \$3,000 from Bob's CB. The store is located in Santa Rosa.

Sixteen pieces of illegal radio equipment were seized including six CB transceivers and ten CB linear amplifiers. The equipment was capable of operating on unauthorized frequencies or at power levels in excess of the limits set by the Commission's Rules.

The marketing, manufacture and use of illegal radio equipment violates Section 302(b) of the Communications Act of 1934,

as amended. Violation of the law carries potential criminal penalties of \$100,000 and one year in prison. The use of such illegal radio equipment can cause harmful interference to safety-of-life services (including law enforcement, aviation and marine), licensees and other CB users. This action is part of a continuing enforcement program to assure that the FCC's ban on manufacturing and selling CB linear amplifiers and other non-type accepted equipment is observed.

### **Amateur Radio Operator Fined \$1,000 For Operating A Pirate Station**

Amateur radio operator Joseph A. Della Barba, N3HGB, of Annapolis, Maryland, was fined \$1,000 for operating a pirate station. An Electronics Technician and Engineer from the FCC's Baltimore and Laurel Offices, located the operator transmitting on radio equipment in his vehicle.

The unauthorized station, using the call-sign "WTNU" (The Nation's Underground), had been initially overheard during routine monitoring of the aeronautical mobile band. Mr. Della Barba was operating on 25,000 kHz which is the standard frequency and time signal assigned to the National Bureau of Standards.

### **Arrested For Interfering With Police Radio**

Using radio-direction finding equipment, FCC electronic engineers located a North Brunswick, NJ man who was causing deliberate interference on New Brunswick, NJ Police radio channels, the FCC said. New Brunswick and North Brunswick police along with the FCC engineers, executed a search warrant at the residence of John S. Kostrub of North Brunswick. Kostrub was arrested on charges of interfering with police operations. Bail was set at \$50,000 following Kostrub's arraignment.

The search capped an FCC investigation of unlicensed radio operation in the Police Radio Service. The Commission had received complaints by the New Brunswick Police which alleged that someone was making racial and sexist comments on police radio frequencies. FCC engineers monitored the frequency and identified the source as coming from the Oak Leaf Village apartment complex where Kostrub lived.

A radio transmitter and scanner radio receivers capable of operating on New Brunswick police frequencies were seized at the apartment. The transmitter was operated without an FCC radio station license. **PC**



# Take Bob's Advice

Bob Grove shares his expertise in two new books...

NEW 1990 EDITION!

## Shortwave Directory

Extensively revised, the new 1990 Shortwave Directory is the consummate DXer's bible for the first 30 MHz of the radio spectrum, including accurate, up-to-date VLF information.

Listings include U.S. and foreign Air Force, Navy, Coast Guard, Army, Energy and State Departments, FBI and FCC networks, scientific installations, spies and smugglers, pirates and clandestines, emergency communications networks, aircraft and ships, NASA Space Shuttle Tracking systems, English language broadcasts worldwide and much more.

Frequencies are cross referenced by agency and frequency for rapid identification. An exhaustive glossary of commonly heard radio terms, acronyms and abbreviations is included. Nearly 300 information-packed pages in an 8½ × 11 inch format.

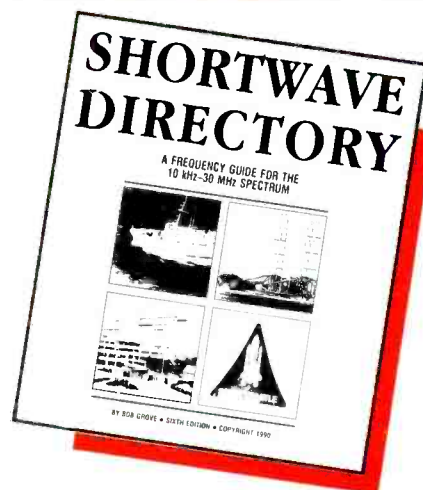

BOK14 . . . only \$19.95 plus \$3.00 UPS/bookrate or \$5.50 Canadian air parcel post.

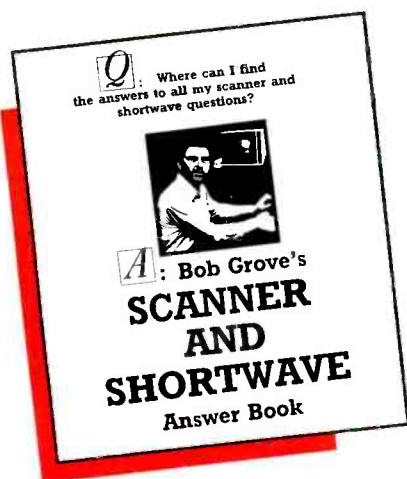

## Bob Grove's Scanner and Shortwave Answer Book

When do you need a preamp for better reception? • What is the best antenna for your requirements? • What do all those technical specifications really mean? • Are radio waves harmful to the human body? • What filters provide the best results?

These are samples of the hundreds of questions expertly answered in Bob Grove's latest guide to monitoring. If you have questions about listening and equipment, chances are you'll find the answers here!

Liberal illustrated and professionally printed, Bob Grove's Scanner and Shortwave Answer Book has been affordably priced for all hobbyists, new and experienced. Take advantage of this limited reference edition while supplies last.

BOK5 . . . only \$12.95 plus \$2.50 UPS/bookrate or \$2.00 Canadian air parcel post.

**Business Hours: 9am-5pm EST Monday through Friday**  
**Orders Only 1-800-438-8155 • Information 704-837-9200**  
**Send orders to Grove Enterprises • PO Box 98PC, Brasstown, NC 28902**

# ANARCON '90

A new decade begins...

Sept. 14-15-16, 1990  
Va. Beach Virginia

- ANARC's Annual Convention
- Commercial Exhibitors & Dealers
- Special Guest - Gordon West WB6NOA
- DX Forums - Technical Forums
- Int'l Broadcasters Forums
- ARRL Division Convention
- Held at the *Va. Beach Pavilion*
- Plenty of FREE Parking
- It's still Vacation Time at the Beach!
- Lots of Nearby restaurants, museums, historic sites - Williamsburg, Busch Gardens, Norfolk Naval Base & more!



*Held In  
Conjunction  
with the  
15th Annual  
Va. Beach  
HamFest*

Talk-In  
146.97

**Tickets & Info**  
ANARCON '90  
P.O. Box 9645  
Norfolk, VA 23505  
(804) 459-3759

Hosted by TRCI and  
Sponsored by:

**WNIS 850AM**  
NEWS RADIO

**Exhibitor Info**  
Lewis Steingold, W4BLO  
3449 Dickens Drive  
Va. Beach, VA 23452  
(804) 486-3800

CIRCLE 57 ON READER SERVICE CARD

## PC SWL \$99.00 A New Digital Radio Reception System

PC SWL contains the hardware, software, instructions and frequency lists needed to allow you to receive a vast variety of digital information transmitted over shortwave radio. Digital information you may be buying from a dial-up service is broadcast free over shortwave radio. Here are just some of the digital information on shortwave:

Weather forecasts  
Wire service news from:  
VOA, Reuters, Tass and AP, Kyodo, and others  
Ham Radio operators  
Ship to shore telex  
Aviation Weather Telex

PC SWL automatically decodes the most common digital transmission modes: Morse code, Radio Teletype, FEC (forward Error Correcting Code), SELCAL (Selective calling transmissions), and NAVTEX.

If you already own an IBM PC or Compatible computer and a shortwave receiver, we have the rest. If you need a shortwave receiver, check our price on the ATS803A.

The product consists of:

Demodulator  
Digital Signal Processing Software  
80 Page Tutorial Reference Manual  
World Press Frequency List  
Tutorial Audio Cassette with Samples

Software Systems Consulting  
150 Ave. Cabrillo "C", San Clemente, CA 92672  
Tel: (714) 498-5784 Fax: (714) 498 0568

CIRCLE 69 ON READER SERVICE CARD

76 / POPULAR COMMUNICATIONS / August 1990

# HOW I GOT STARTED

Popular Communications invites readers to submit, in about 125 words, how they got started in the communications hobby. Each month, we'll accept them, (preferably) typewritten, or otherwise easily legible. If you have a photo of yourself taken recently, or when you got started, please include it with your story. We can't return or acknowledge your material, whether we use it or not. You need to submit your story only once, we'll keep it on file and consider it for future issues. All submissions become the property of Popular Communications.

Entries will be judged taking into consideration if they tell a story that is interesting, amusing, or unusual. We reserve the right to make any minor wording changes to improve style.

Each month our new winner will receive a 1-year gift subscription to (or 1-year subscription extension) to Popular Communications.

Address all entries to: How I Got Started, Popular Communications, 76 North Broadway, Hicksville, NY 11801.



## Our Winner For August

For August, we note the entry into radio of Steven O. Sellers, N5GZP, of San Diego, CA. Steven tells us: "I got started as a radio hobbyist with the help of my brother and a gift from a friend.

"My brother, Ron, purchased a pair of handie-talkies and needed someone to talk to. I was elected, and became hooked at an early age. A family friend, sensing my interest, donated a beloved Hallicrafters receiver that had heirloom status. By age 12, I had obtained a ham ticket. At age 15, I began working at a local radio station.

"Back in the early 1960's, my brother and that perceptive friend started me on a lifelong hobby and career. Today, I still enjoy hamming and SWL'ing. And I am a news director at a highly rated San Diego radio station (*Magic 102-FM*)."

PC

THE MONITORING MAGAZINE

# COMMUNICATIONS SHOP

**Advertising Rates:** SCAN members and POP/COMM subscribers are entitled to one FREE 30-word, non-commercial classified ad per year. Enclose subscription name label with ad copy. For those people not in the previously mentioned groups, non-commercial ads are 30 cents per word, including abbreviations and addresses; minimum charge \$6.00 per issue. Ads from firms offering commercial products or services are \$1.00 per word; minimum charge \$20.00 per issue. Boldface words are \$1.20 each (specify which words). Leading key words set in all caps at no additional charge. All ads must be prepaid in full at time of insertion; a 5% discount is offered for prepaid 6 time insertions. All ads must be typewritten double spaced.

**Approval:** All ad copy is subject to Publisher's approval and may be modified to eliminate references to equipment and practices which are either illegal or otherwise not within the spirit or coverage scope of the magazine.

**Closing Date:** The 10th day in the third month preceding date of publication. Because the advertisers and equipment contained in Communications Shop have not been investigated, the Publisher of Popular Communications cannot vouch for the merchandise listed therein. Direct all correspondence and ad copy to: PC Communications Shop, 76 N. Broadway, Hicksville, NY 11801.

**ELECTRONIC SPYING** is the name of the game. It's also the title of a startling book which reveals the closely guarded methods & equipment used by professionals & amateurs who eavesdrop on homes & businesses with (sometimes) legal and (usually) illegal bugs & wiretaps. Written in non-technical language everyone can easily understand, ELECTRONIC SPYING has photos & illustrations clearly revealing exactly how they do it & where they get the equipment (much of it inexpensive & easily available). Leaves nothing to the imagination! Latest techniques covered & offers an in-depth wealth of information on the ever increasing electronic invasion unavailable from any other source. This book is used by law enforcement agencies as a reference manual. Only \$8.95 (plus \$1.00 postage) per copy from CRB Research, P.O. Box 56, Commack, N.Y. 11725. (NY residents add sales tax.)

**WORLD'S MOST UNUSUAL Communications Books!** A large selection of outstanding titles covering scanners, "confidential" frequency registries, bugging, wire tapping, electronic surveillance, covert communications, computers, espionage, monitoring, and more! New titles being added constantly! Ask for our large new FREE catalog. CRB Research, Box 56-PC, Commack, NY 11725.

**SIDEBAND OPERATORS!** Join the oldest/largest network of 27 MHz SSB operators. Now more than 100,000 strong! Send self-addressed stamped long (#10) envelope for FREE details and application (no obligation). SSB Network, P.O. Box 908, Smithtown, NY 11787.

**COMMUNICATIONS PLANS, BOOKS, KITS!** AM/FM broadcasting (licensed/unlicensed), 1750 Meter transceivers, Ham/CB amplifiers, surveillance bugs, more. FREE catalog. PAN-COM, Box 130-P11, Paradise, CA 95967.

**CABLE TV CONVERTERS.** Scientific Atlanta, Jerrold, Oak, Zenith, Hamlin. Many others. "New" MTS Stereo Add-On. Visa, M/C & Amex **1-800-826-7623. B&B Inc., P.O. Box 21-327, St. Paul, MN 55121.**

**TOMCAT'S BIG CB HANDBOOK**, by Tom Kneitel. Just published, 221 large pages, fully illustrated. Complete guide to worldwide AM, SSB, Freeband, 27 MHz operations. Everything they never told you (legal & otherwise) from world's leading CB authority. Only \$13.95 (plus \$2 postage to North America) from CRB Research Books, Inc., P.O. Box 56, Commack, NY 11725. (NYS residents add sales tax). Dealer inquiries invited.

**PRO2004 OWNERS-400 CHANNELS/30 CPS SCAN RATE KIT \$35.00 INSTALLED-\$55.00.** LESTER JERNIGAN, P.O. Box 5212, Jacksonville, AR 72076.

**SCANNER FREQUENCY SEARCH SERVICE** Hear all there is to hear! SASE to: Heald, 6886P Jefferson Street, North Branch, MI 48461.

**Tune In On Telephone Calls.** Tom Kneitel's new 160-page book. Everything you need to know to effectively use a scanner and communications receiver to eavesdrop on private telephone calls from homes, offices, cars, ships, aircraft, trains. Explanatory text, photos, extensive listings section covers USA/Canada on HF, VHF, UHF, and above; thousands of locations, frequency assignments. Explains equipment, best techniques, laws regarding monitoring cellular, cordless, ship/shore, high seas, Air Force 1, airliners, 1-way paging, more. Only \$12.95 (plus \$2 postage to USA/Canada/APO/FPO) from CRB Research, Box 56, Commack, NY 11725. NY residents add sales tax. Dealer inquiries invited.

**TELEVISION SETS made before 1946 wanted for substantial cash.** Especially interested in "mirror-in-the-lid" and spinning disc sets. Finder's fee paid for leads. Arnold Chase, 9 Rushleigh Road, West Hartford, CT 06117 (203) 521-5280.

**BUGGED? COUNTERMEASURE SWEEPS.** Telephones, Offices, Watercraft, Aircraft. Confidentiality Assured. Write or call for a free eavesdrop brochure and estimate. Central States Investigations, 1007 West Jefferson Street, Suite 160, Springfield, IL 62702-4835. AC/217 525-9499.

**NEW! UNDERSTANDING & REPAIRING CB RADIOS** by Lou Franklin. Giant 380-page technical book picks up where THE "SCREWDRIVER EXPERTS" GUIDE leaves off. Includes circuit descriptions and troubleshooting guide for virtually all CB radios: 23 and 40-channel, crystal and PLL, solid-state and tube, AM, FM, SSB, CW, American, British and export models. Covers test equipment, transistor basics, synthesizers, receivers, transmitters, power supplies, T/R switching, antennas, interference, parts and accessory sources. Over 350 illustrations plus huge subject index. Moneyback Guaranteed Only \$29.95 plus \$3.50 U.S. & Canadian Air Mail, VISA/MC accepted. Free catalog of unique CB books, plans, and modification kits with order. Catalog only, \$2. CB CITY INTERNATIONAL, BOX 31500PC, Phoenix, AZ 85046. Thousands of satisfied customers since 1976.

**Radio New York International** official off the air recording of our first broadcast live from the good ship Sarah. \$15.00 gets you a 60 minute cassette, plus an official letter and certificate from the RNI staff. RNI, Monticello, Maine 04760.

**WANTED-PRO2004's** in non-working condition. Wanted for parts will pay reasonable price. Must have all internal parts. Send description and price wanted to Lester Jernigan, P.O. Box 5212, Jacksonville, AR 72026.

Interested in FM CB radio? For more information send SASE business envelope plus \$3 to GMRS, 107 West Caldwell, Phoenix, AZ 85041.

**THE NEW YORK MONITOR NEWSLETTER**—a monthly Newsletter that provides CB'ers with the latest up-to-the-minute Technical information—Radio Repair and Modification—Phase Lock Loop (PLL) Circuit/Expander—**2 YEAR COURSE IN ELECTRONIC COMMUNICATION** and much much more!! \$24 per year mail to **LORD/WYATT COMMUNICATIONS, P.O. Box 030128PCD, Brooklyn, NY 11203-0001.**

**HURRY!** Get in the **WORLDWIDE CB DIRECTORY.** Correspond with CB'ers all over the world. For free info rush a (#10) SASE to: **WORLDWIDE CB DIRECTORY, P.O. BOX 19786, Dept. C, New Orleans, LA 70119.**

**AM/FM/TV BROADCAST BAND AIRCHECKS** of metropolitan New York, N.J. & CT. area stations. Caught a NY station in the dead of night? Verify your logs with top-quality airchecks. Send your requirements for a free price quote to: AiResponse, 553 E. Fulton St., Long Beach, NY 11561-2416.

**PRO-2004/5 OWNERS:** Search-and-Store finds elusive frequencies while you work or sleep. Internal no-holes installation—Key-board control—retain present functions. Wired-tested-postpaid: Ten channel \$24.95 (check)—Selectable to 255 channels \$44.95 Key Research, POB 846P, Cary, NC 27512-0846.

## AMPLIFILTER™

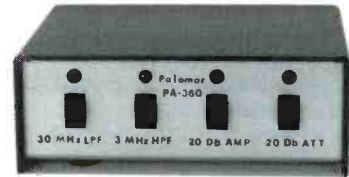

- Improves shortwave reception.
- Use with any antenna, any receiver.
- Front panel control of all functions.

New! Amplifilter™ gives 20 db preamplifier gain or 20 db attenuation and cuts out overload and crossmodulation from local AM broadcast and TV/FM stations.

It has a broadband .1 to 1000 MHz amplifier, an attenuator, a 3 MHz highpass filter, and a 30 MHz lowpass filter. They are individually selectable by front panel switches, one at a time or in any combination.

**Model PA-360 Amplifilter™ \$79.95 + \$4 shipping/handling in U.S. & Canada. For 12v DC. Model PS-90 AC adapter \$9.95.** California residents add sales tax.



Send for FREE catalog that shows our complete line of antennas, pre-amplifiers and filters.

## PALOMAR ENGINEERS

BOX 455, ESCONDIDO, CA 92033  
Phone: (619) 747-3343

## GILFER — first in Shortwave



The Best Active Scanner Antenna Gets Better and Better...DRESSLER ara-1500.

Latest model in the evolution of this famous series, the 1500 offers wider freq. coverage (50-1500 MHz), high gain (11-16dB), and easy installation (indoors or out, vertically). Ideal for the ICOM R7000 and other wideband VHF/UHF receivers. Includes 12 vdc power supply, coupler, 25' coax, and mounting hardware \$189.95 (+\$8).

### VISIT GILFER'S STORE

Easy to find, accessible from New York City. Take Garden State Parkway (NE portion of N.J.), Exit 172. Gilfer is in the center of Park Ridge, opposite the Borough Hall. Store hours: M-F 10am-5pm, Sat. 10am-3pm.

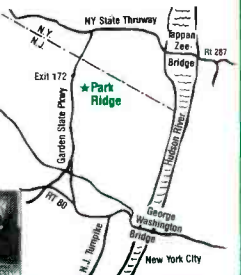

Order operators: 1-800-GILFER-1  
(1-800-445-3371) NJ 201/391-7887  
**GILFER SHORTWAVE**  
52 Park Ave. • Park Ridge, NJ 07656

CIRCLE 65 ON READER SERVICE CARD

## Advertiser's Index

|                             |              |
|-----------------------------|--------------|
| AMC Sales, Inc.             | 47           |
| ANARCON '90                 | 76           |
| ARRL                        | 17           |
| Ace Communications, IN      | 80, Cov. III |
| Antenna Specialists         | 73           |
| Antennas West               | 59, 65, 79   |
| Antique Radio Classified    | 45           |
| Associated Radio            | 62           |
| Barry Electronics           | 61           |
| CBC International           | 61           |
| CQ Buyer's Guide            | 15           |
| CRB Research                | 11, 19, 38   |
| Cellular Security Group     | 53           |
| DECO                        | 79           |
| Electrolert                 | 79           |
| Electron Processing         | 13           |
| Electronic Engineering      | 61           |
| Electronic Equipment Bank   | 1            |
| GRE America, Inc.           | 37           |
| Gilfer Shortwave            | 77           |
| Grove Enterprises           | 75           |
| Hamtronics, Inc.            | 79           |
| ICOM                        | 42, Cov. II  |
| JoGunn Ent.                 | 61           |
| Kenwood U.S.A. Corp.        | Cov. IV      |
| MFJ Enterprises, Inc.       | 27           |
| Medicine Man                | 59, 79       |
| Metrowest                   | 53           |
| OPTOelectronics             | 5            |
| Pacific Cable Co.           | 65           |
| Palomar Engineers           | 77           |
| POP'COMM Book Shop          | 68           |
| React, International        | 45           |
| Republic Cable Pdts., Inc.  | 45           |
| Scanner World, USA          | 7            |
| Signal Engineering          | 28           |
| Software Systems Consulting | 18, 79       |
| Somerset Electronics        | 53           |
| Systems & Software          | 76           |
| Universal SW Radio          | 3            |
| Z Co.                       | 79           |

Reach this dynamic audience with your advertising message, contact Don Allen, N9ALK at (217) 344-8653.



Readers can obtain free information on products advertised by the above companies, as well as for some editorially mentioned products. Simply circle the appropriate number printed below an advertisement onto the card bound into this issue.

**SURVEILLANCE-DETECTION EQUIPMENT, TRANSMITTERS, DEBUGGING, SECURITY ITEMS, TELEPHONE LOGGING RECORDERS. \$5.00 CATALOG, EAVESDROPPING DETECTION EQUIPMENT, P.O. BOX 1087, WILLIAMS-VILLE, NY 14231.**

**TOUCH TONE DECODER DISPLAYS DIALED NUMBERS ON CORDLESS, CELLULAR, CONNECTS EASILY TO SCANNER. INFORMATION FOR SASE. W.E.B., P.O. B. 2771, SPRING VALLEY, CA 92077.**

For Sale: ICOM R-7000, remote control, GTI Electronics Panel adaptor, BK-Precision Model 2120 Oscilloscope, Grove Power Antenna III Preamplifier, Grove SP-100 Radio Speaker, Grove Scanner Beam Antenna, ICOM AH-7000 Discone Antenna, Radio Shack Antenna Rotator, AOR-900 Handheld Scanner, Leather Case, Magnetic Mobile Antenna, Frequency Books, All manuals. Call Jim (404) 535-2509.

**SCANNER MODIFICATION HANDBOOK, FERRELL'S CONFIDENTIAL FREQUENCY LIST, AIR SCAN.** Plus many other books by CRB, SAM'S, TAB, ARRL and others, many at reduced prices. We take phone orders and VISA/MASTERCARD. FREE Catalog. **DOYLE COMMUNICATIONS-PC, Route 8, Box 18, Lake Pleasant, NY 12108 (518) 548-5515.**

Exciting! New radio club now formings in the New York City Tri-State area. If you're a radio buff and wish to join a 461 to 465 MHz repeater club and you own a UHF transceiver then send your name, address and phone number to David M. Torres, 215 West 94 Street, New York, NY 10025 for info.

**NORTHEAST SCANNING NEWS:** A monthly UHF/VHF scanner publication for readers from Maine to Virginia. 52 pages per issue. Over 500 subscribers. For sample copy, send \$2.00 cash, check or money order made payable to: LESMATTSON and mail to NESN, 212-P West Broad Street, Paulsboro, NJ 08066.

I make \$2000/week recycling PURE GOLD from electronic scrap! You can too! FREE REPORT (worth \$25). Call recorded message: 1-900-246-2323 (\$2 min.)

**BEST PRICES: CB RADIOS and ACCESSORIES,** Radar Detectors, Scanners. Free list. CRS Communications, 1692 Central Park Ave., Yonkers, NY 10110.

**NEW AOR-1000 WITH CELLULAR!** \$455, BC-200 XLT with cellular \$269, TS-2 cellular \$299, BC-800XLT \$259, much more! 28 page 1990 picture catalog \$1.00 used gear list. 25. We take trades! GALAXY, Box-1202, Akron, Ohio 44309 (216) 376-2402 9-5 pm EST.

SONY ICF-7600A, DR QSO trainer w/key fits Commodore. POP'COMM back issues Mar. 83-Jan. 89 complete. \$150 + UPS, 7965 Cholo Tr., JAX, FL 32244—904-777-1076.

**Texas Radio Frequency Guide.** Thousands of listings. Covers kHz thru GHz. \$11.45 postpaid from Luna Lumen Press, Box 58023-P, Houston, TX 77258.

**NEW! 7th Edition: Top Secret Registry of Government Radio Frequencies,** by Tom Kneitel. Grown to gigantic 240 pages! 1000's of new listings, frequencies, stations for all scanner owners, nationwide. Includes: FBI, DEA, Customs, Secret Service, FCC, Immigration, Border Patrol, U.S. Attorney, ATF, Treasury, Fed. Prisons, U.S. Marshal, CIA, Postal Service, NSA, NORAD, USAF, USN, Army, USMC, FAA, NASA, DOE, NRC, FEMA, Dept. Agriculture, National Parks, USCG, EPA, DOT, V.A., UHF aero (225 to 400 MHz) listings, bugs & surveillance freqs, agents' lingo, codes, many more agencies, lots more info! Expanded Canadian listings. Only \$19.95, plus \$2 postage to N. American addresses. NY State residents add \$1.50 sales tax. Order now from CRB Research Books, P.O. Box 56, Commack, NY 11725. Dealer Inquiries Invited.

YAESU FRG-9600, mint, \$335. SONY ICF-2010, \$235. C-64 \$80. Disk Drive \$100. Color Mon. \$110. Printer \$100. MFJ-1278 \$240. Call Arnie (313) 399-4646.

**Buy direct our top quality uninterruptible power system - at substantial saving. These extremely reliable products available in wide range of power rating to accommodate a variety of user needs. Write today for free catalog, features a broad range of our power conditioning products. Send us your name, address, plus \$1 for postage & handling to: ALPINE INDUSTRIES, 9126 Medill, Franklin Park, IL 60131.**

WANTED: radio-related contacts in JAPAN. Names and addresses of Japanese radioenthusiasts and radiostores in importing purpose. Please write to: Anssi Nieminen, P.O. Box 35, SF-40321 JYVASKYLA, Finland.

FOR SALE: Yaesu FRG-7700, memory unit, DC kit, FRT-7700 tuner, FF-5 LP filter, service manual. Absolutely new condition, \$375 firm. Includes shipping. John, 301-247-4712.

POP'COMM back issues. May 1985 thru June 1990. (Missing Nov. 89) \$99 Inc. Shipping. Send a S.A.S.E. to: K. Lanoue, P.O. Box 1610, North Adams, MA 01247.

**NEW! AIR-SCAN 5TH EDITION** by Tom Kneitel. Complete guide to aero comms. Now in gigantic 192-page large-size format containing 60,000 + listings, including 2-30 MHz HF, 118 to 174 MHz VHF, 406 to 512 MHz UHF, and 800 MHz listings. Covers civil, military, private, and unlisted landing areas, heliports, and seaplane bases. Control towers, ground, approach/departure, FSS, unicoms, multicomms, crop dusters, air-ambulances, federal ops, traffic 'copters, aviation business, airline enroute, airport security/fire, etc. throughout USA. All Canadian mil, civilian airports and seaplane bases listed, plus lots more, including how-to text on aero monitoring. Most comprehensive aero frequency guide ever compiled. Only \$14.95 + \$2 postage to USA/Canada/APO/FPO. NY State residents add \$1.13 sales tax. From: CRB Research Books, Inc., P.O. Box 56, Commack, NY 11725, or ask your favorite communications dealer.

**SCANNER MODIFICATION HANDBOOK** by Bill Cheek ("Doctor Rigormortis"). New 160-page book. More than 20 performance improvement modifications. Simple step-by-step instructions, many photos. Primarily PRO-2004 & PRO-2005, some for PRO-34, BC-200/205XLT, BC-750XLT, BC-750XLT. Restore blocked out bands, speed up scanning rate, disable "beep," increase number of channels, improve squelch action, add an S meter, interface with shortwave receivers, etc. Make the PRO-2004 & 2005 into a 6,400 channel scanner; put 3,200 channels into the PRO-34! Plus, cellular frequency charts, antenna info & m o ds, inside info on frequency management, operating hints, emergency power supplies, scanners & the law, lots more! Just issued, latest info. Only \$17.95, plus \$2 postage to addresses in USA/Canada. Residents of NY State add \$1.35 tax. CRB Research Books, P.O. Box 56, Commack, NY 11725.

WANTED: Someone who would like to donate a used twenty channel programmable scanner to a bedridden gentleman. Willing to pay all shipping charges. Call collect anytime (304) 232-3563.

**ONE TOLL-PHONE CALL COULD EARN YOU \$500.** We are a nationwide market leader in the fire/water restoration business and we are looking for people across the country, **LIKE YOU**, to join our team. If you are interested in learning more about our **FIRE SPOTTERS NETWORK**, please apply to J. Winn, P.O. Box 1888, South San Francisco, CA 94083-1888.

**COMMODORE 64 HAM PROGRAMS**—8 disk sides over 200 Ham programs—\$16.95. 25¢ stamp gets unusual software catalog of Utilities, Games, Adult and British Disks. Home-Spun Software, Box 1064-PC, Estero, FL 33928.

**LEARN VCR Cleaning, Repair. Huge Profits! Secrets Revealed! No Experience Necessary. Better than Viejo at 1/7 the cost. 400+ page book, with 704 illustrations. \$24.95, postpaid. Worthington Publishing, 6907-202J Halifax River Drive, Tampa, FL 33617, or call (813) 988-5751 for C.O.D., Visa, or MC. Money-back guarantee.**

**DISCOUNT BOOKS, SCANNERS, ANTENNAS:** We have radio books and frequency books by TAB, SAM'S, ARRL, CRB, McGraw Hill and others, many at discount prices. FREE catalog. **DOYLE COMMUNICATIONS**, Route 8, Box 18, Lake Pleasant, NY 12108 (518) 548-5515.

MTC-101 Microphone Test Center—repair and test any CB microphone only \$64.95 S/H included—send to **LORD/WYATT COMMUNICATIONS**, 30 East 54 Street, Brooklyn, NY 11203-718-493-3778 7 PM-10 PM EST \$15.00.

**ICOM R7000 + IBM-PC + 801-SCAN = ULTIMATE SCANNING SYSTEM!** Scan 1800 channels in 200 banks. Scan faster, with quick control of scanned bank, delay mode, etc. Version 2 has MANY more advanced features, the best scanning system for the R7000! IBM/clonew/512K required. Program with external interface (use your RS-232): \$134.95. With internal I/F: \$149.95. Demo program (R7000 NOT required): \$3.55. Free information. 801-SCAN Suite 212, 397 Dal-Rich Village, Richardson, TX 75080.

**SURVEILLANCE / COUNTERSURVEILLANCE** devices catalog. Camera's, bug detectors, video camera detectors, transmitters, communications, and much more. Catalog \$3.00. DSP P.O. Box 1275-PC, Redondo Beach, CA 90278.

**SURVEILLANCE-COUNTERMEASURES!** Transmitters, detectors, phone security, night vision, stunguns, secret devices, restricted books. **MORE! GUARANTEED LOWEST PRICES! HUGE CATALOG \$5.00 (REFUNDABLE)** Protector, P.O. Box 520294, Salt Lake City, UT 84152.

**CW Lite** is the **easiest** Morse code training method in the world, bar none! And it is the **fastest**, too. Just close your eyes and relax. This powerful **hypnosis cassette tape** does the rest. **Subliminals** speed you along! Only \$14.95 ppd in US (NY residents add \$1.12 tax). Order today! **PASS Publishing**, Box 570, Stony Brook, NY 11790.

**CODES, CIPHERS, AND SECRET LANGUAGES**—Thomas Jefferson's cipher wheel, heliograph signals, Morse code, American Indian signs, Esperanto and much more. With quizzes and brain teasers for each section, this book is filled with fun and intrigue! Order today! Hardcover, 272pp. Send \$21.45ppd to Paladin Press, P.O. Box 1307-91ZA, Boulder, Colorado 80306. (303) 443-7250.

**VIDEOIPHER II Manuals.** Volume 1 - HARDWARE, Volume 2 - SOFTWARE \$32.45 each. Volume 3 - PROJECTS/SOFTWARE - \$42.45. Volume 4 - REPAIR/SOFTWARE - \$94.45. Volume 5 - DOCUMENTATION - \$42.45. Volume 6 - EXPERIMENTATION - \$42.45. CLONE HACKERS BIBLE - \$34.95. CABLE HACKERS BIBLE - \$32.45. COD's 1-602-782-2316. 0100-032 Software Catalog - \$3.00 TELECODE Box 6426-PC, Yuma, AZ 85366-6426.

**PRIVACY PROBLEM—NEED INFORMATION?** New Electronics Surveillance, Debugging, Protection Catalog \$5.00 Kits—Assembled. TECHNOLOGY SERVICES, 829G Ginette, Gretna, LA 70056.

**CW? NO PROBLEM.** You can increase your speed, no matter how many times you've failed before. **Results guaranteed** when you follow the instructions. PASS Publishing's **CW Mental-Block Buster** program helps you **explode mental blocks** that hold you back. Based on 40 years of research, the **CW Mental-Block Buster** uses guided meditation, dynamic visualizations, and powerful affirmations to blast through mental blocks. **You can do code!** That means new bands, more contacts, more fun! (This is not a CW practice tape.) The **CW Mental-Block Buster** audio cassette and practice booklet are only \$24.95 ppd. in the US (NY residents add \$1.87 sales tax). (Quantity discounts available for classes.) PASS Publishing, P.O. Box 570, Stony Brook, NY 11780.

**Morse code got you down?** Why let a mental block stand between you and upgrading? Use PASS Publishing's **CW Mental-Block Buster** to blast through those barriers. Just follow the instructions for 30 days—**Results Guaranteed!** Based on 40 years of research, the **CW Mental-Block Buster** uses guided meditation, dynamic visualizations, and powerful affirmations to blast through mental blocks. **You can do code!** That means new bands, more contacts, more fun! (This is not a CW practice tape.) The **CW Mental-Block Buster** audio cassette and practice booklet are only \$24.95 ppd. in the US (NY residents add \$1.87 sales tax). (Quantity discounts available for classes.) PASS Publishing, P.O. Box 570, Stony Brook, NY 11780.

**BUGGED? WIRETAPPED?** Find out fast! Factory direct countermeasures equipment catalog \$1. Capri Electronics, Box 589W, Bayfield, CO 81122.

**TAPESPONDERS:** Looking to hear from anyone who was involved, or would like to become involved in all types of tapspendence. Write: Harry Bergman, P.O. Box 180, New York, NY 10033.

**225-400 MC RECEIVERS** Tunable, Government Reconditioned. Satcom Antennas 240-270 MC Military Helical Type. New (419) 726-2249.

**BLIND,** shut-in seeks donations of any CB, word processor or shortwave radio please write Richard Jastrow, 5909 W. 6th St., Los Angeles, CA 90036. Call (213) 938-5347.

**FREE RADIO GEAR!** Learn the art of obtaining radio equipment. No Cost To You! Guaranteed Results. Details. Send \$5.95 to: Radio Wisdom, PO Box 231-PC, Brice, Ohio 43109.

**SCANNERS, CBs, ANTENNAS, LOWEST PRICES REGENCY, BEARCAT, UNIDEN, COBRA.** CATALOG \$2 S.P.W. 921 BROADWAY, CHESTERTON, IN 46304 VISA/MC ACCEPTED (219) 926-1448.

**TRI-MARK RECEIVER MARKER KIT:** three crystal controlled outputs cover HF through UHF. Circuit board with all parts, switches: only \$19.95 plus \$1.25 shipping. NY add \$1.45 sales tax. Send SASE for flyer. TWO FOX ELECTRIX, POB 721, Pawling, NY 12564-0721.

**Two Meter Specials** Motorola Micros, 45 watt, 4 or 8 Freq, 132-150 MHz, *Drawer Unit Only*, \$80.00 each, with all accessories. 4 or 2 F Scan Accessory Group, \$150.00 each. GE Exec II 138-155 MHz, 40 watt, *Drawer Unit Only*, \$80.00 each, with 2 F Scan Accessories \$150.00 each. GE Exec II, 42-50 MHz, 50 watt, *Drawer Unit Only*, \$80.00 each, with accessory group, \$150.00 each. GE Century II 1, 2, or 6 Freq, 25 watt, 138-155/148-174, with all accessories, \$95.00 each. Standard HX-300 portables, 138-144 MHz, \$150.00 each. CALL OR WRITE FOR CURRENT FLYER. ALL SALES "CASH" OR "CERTIFIED FUNDS" SHIPPED BY UPS. C. W. WOLFE COMMUNICATIONS, INC., 1113 Central Avenue, Billings, Montana 59102. FAX (406) 252-9617, TELEPHONE (406) 252-9220.

Antique radio, tubes, wiring diagrams, & literature, send 2 stamps to VRS(PC) PO Box 541, Goffstown, NH 03045 for large list.

**STOP THE ELECTRONIC THIEVES.** Techniques, Equipment, Laws. Free Information. SVS 198 N. 2nd St. Suite 6, Porterville, CA 93257 (209) 782-1681.

**The Red Onion Express Bulletin Board has moved to 914-342-4585. Free. 24 hours a day. Set your modem to 300, 1200, or 2400 baud. Scanner and Shortwave information. NO ringback!**

Interested in pirate radio? Clandestine broadcasting? Spy stations? There's no better source of information than the Association of Clandestine Radio Enthusiasts, P.O. Box 11201, Shawnee Mission, KS 66207-0201.

**JRC NRD-525 HF Receiver**



- Receive 90 kHz to 34 MHz V/UHF
- With Optional CMK-165 Converter
- 200 Memory Channels
- AM, FM, U/LSB, RTTY, FAX
- Multi Scan Feature

**CALL TODAY!**

**ICOM IC-R9000**



**THE FINE ART OF LISTENING**

- Continuous, All-Mode Receiver
- Covers 100 kHz to 2 GHz
- 1,000 Memories
- Advanced CRT Display
- Direct Digital Synthesizer System

**CALL FOR ALL DETAILS!**

**ICOM IC-R71A**



**SUPERIOR PERFORMANCE RECEIVER**

- USB, LSB, AM, RTTY and Optional FM
- Covers .1 to 30 MHz
- 32 Memory Channels
- Multi Scanning Functions
- Keyboard Frequency Entry

**CALL TODAY!**

**KENWOOD R-5000**



**HIGH PERFORMANCE RECEIVER**

- Covers 100 kHz to 30 MHz
- 100 Memories
- Keyboard or Main Dial Station Selection
- Programmable Scanning

**CALL TODAY FOR DETAILS!**

**Amateur and SWL Accessories**

**HAMTRONICS, INC.** M, T, W (9-6)  
Th, F (9-8)  
Sat (9-3)

4033 Brownsville Road, Treose, PA 19047  
For Service & Info (215) 357-1400 For Orders (800) 426-2820 FAX 215-355-8958

**World Probe**



**World Band Scanner Antenna**

- Cuts Noise • Improves Reception • Indoors or Out • Works with all World Band Portables and Scanners • Sleek 6-ft Probe with Integral 25-ft Low-Loss Shielded Feedline • Fully Insulated and Weather Sealed • Decorator White Design

**AntennasWest** Box 50062-P, Provo, UT 84605 **FREE** Storage Pouch & Universal Connector Kit

Circle 48 on Reader Service Card

**CB TRICKS OF THE TRADE I & II**

Tricks I and Tricks II, plus a free set of plans for CB Super Modulation.

**Special: \$40.00**

Order each book separately for \$19.95

C.O.D. Orders Accepted

**Medicine Man CB**  
P.O. Box 37  
Clarksville, AR 72830  
(501) 754-2076



Circle 47 on Reader Service Card

**BEAT THE BEAR IN THE AIR**

For info on the Sport of Spying

Write or Call:

**Spybuster™**

Dept. PC, 4949 S. 25-A, Tipp City, OH 45371  
513 - 667-2461

Circle 58 on Reader Service Card

**Macintosh**



Ham training, World clock, propagation, logging, etc. **Software** largest selection in the world. Free Info.

**ZCo Corporation**  
P. O. Box 3720, Nashua, NH 03061  
(603) 888-7200 Fax: (603) 888-8452

Circle 49 on Reader Service Card

**PICKS UP A WHISPER 50 FEET AWAY!**



The model WAT-50 miniature FM transmitter uses a 4-stage circuit NOT to be confused with a simple wireless microphone. Simply snap the unit on top of a 9V battery and you can hear every sound in an entire house up to 1 mile away! Use with any FM radio. Tunes to any frequency from 70mhz - 130mhz. Easy to assemble kit includes all parts and instructions. Only 29.98 tax incl.



The **WIRELESS TELEPHONE TRANSMITTER** model WTT-20 is only about the size of a dime, yet transmits both sides of a telephone conversation to any FM radio with crystal clarity. Completely automatic. Uses power from the telephone line itself - never needs a battery! Up to 1/4 mile range. Tunes from 70mhz - 130mhz. Easy to assemble kit includes all parts and instructions. Only \$29.98 tax incl.

Call or send MO, VISA, MC for immediate delivery. Single kit orders include \$1.50 S&H. **FREE SHIPPING** on orders of 2 or more. All orders shipped by U.S. Mail. COD add \$4.00. Personal checks allow 21 days.

**DECO INDUSTRIES**  
BOX 607, BEDFORD HILLS, NY 10507  
914-232-3878

Circle 52 on Reader Service Card

**Secret Frequencies!**



Turn those hours of searching for secret frequencies over to the Remote Computer Scanning System. RCSS runs on any Macintosh, and gives you complete monitoring and automatic logging of all signal activity found by your R-7000. You're no longer limited by built-in frequency storage, search, and selections provided by ICOM. Our built-in database also allows importing/exporting between most Mac databases.

**Complete System incl. Interface, Software & Manual only \$189.95 • Dealer Inquiries Invited**

Call or Write for More Information and Customized Versions

**Systems and Software International, Ltd.**  
4639 Timber Ridge Drive • Dumfries, VA 22026  
(703) 680-3559

Circle 51 on Reader Service Card

# AOR Scanners.

Great Performance. Great Service. Great Value.

Free Freight  
25-Day Money-Back Guarantee  
Toll-Free Service and Support  
No Credit Card Surcharge  
One Year Warranty



**AR1000**

**\$499**

**1000 Channels. 8-600MHz, 805-1300MHz**

**Standard Features:**

- Extremely compact size.
- Continuous coverage (except UHF TV 600-805)
- Antenna attenuator switch, 10db.
- Manual tuning knob.
- Earphone jack, 3.5mm.
- AM, FM and wide band FM tuning modes.
- Backlighted LCD display.
- 10 Scan Banks, 10 Search Banks.
- Selectable Priority Channel.
- Delay, Hold Features.
- Selectable Search Increments, 5-955KHz.
- Permanent memory backup.
- 4 AA Ni Cad batteries included.
- AC adaptor/charger.
- Carry Case.
- Cigarette Lighter Charger.
- Belt Clip.
- Earphone.

**Options:**

- External Speaker. Mobile Mount. MS190 \$19.50
- Extended Warranty. 2/3 yrs \$45/\$55

**Specifications:**

- Coverage: 8-600, 805,1300MHz
- Sensitivity: .35uV NFM, 1.0uV WFM, 1.0AM
- Speed: 20 ch/sec. scan. 40 ch/sec. search
- IF: 561.225, 58.075, 455KHz or 10.7MHz
- Increments: 5 to 955KHz selectable/ 5 or 12.5 steps.
- Audio: .4 Watts
- Power: Input 9 - 13.8 V. DC
- Antenna: BNC
- Display: LCD
- Dimensions: 6 7/8H x 1 3/4D x 2 1/2W. 12oz wt.

**AR950**

**\$239**



**100 Channels. Low, Air, High, UHF & 800MHz.**

**Standard Features:**

- Extremely compact size.
- Unrestricted 800MHz coverage.
- 100 channels permanent memory.
- Earphone Jack & Attenuator.
- Delay, Hold features.
- Channel 1 Priority.
- 5 Scan Banks, 5 Search Banks.
- Telescopic and Flexible Antennas w/ BNC connector.
- AC & DC Power cords w/ mtng hardware.
- One Year Limited Warranty.

**Options:**

- Base type antenna
- 25 to 1000MHz w 50'coax. AS300 \$59.95
- Mag Mnt Mobile Antenna. 15' coax. MA100 \$25.00
- Cigarette Lighter power adaptor. CP100 \$4.00
- External Speaker
- with mobile mount. MS100 \$19.50
- Extended Warranty. 2/3 yrs \$40/\$55

**Specifications:**

- Coverage: 27-54, 108-174, 406-512, 830-950MHz
- Sensitivity: .4uV Lo,Hi. .8uV Air. .5uV UHF. 1.0uV 800
- Scan Speed: 15 ch/sec.
- IF: 21.4MHz, 455KHz
- Increments: 10,12.5,25,30
- Audio: 1W
- Power: 12.8VDC, 200MA
- Antenna: BNC
- Display: LCD w/backlight
- Dimensions: 2 1/4H x 5 5/8W x 6 1/2D. 14oz wt.

**We offer 100's of communications products.**

**AR900**

**\$259**



**100 Channels. Low, Air, High, UHF & 800MHz.**

**Standard Features:**

- Extremely compact size.
- Unrestricted 800MHz coverage.
- 100 channels permanent memory.
- Earphone Jack & Display Backlight.
- Delay, Hold features.
- Channel 1 Priority.
- 5 Scan Banks, 5 Search Banks.
- Two Flexible Antennas w/ BNC connector.
- Rechargeable battery set w/charger.
- One Year Limited Warranty.

**Options:**

|                                   |       |           |
|-----------------------------------|-------|-----------|
| Heavy Leather Carry Case.         | CC880 | \$28.00   |
| Earphone.                         | EP200 | \$2.00    |
| External Speaker. Mobile Mount.   | MS190 | \$19.50   |
| Extra Rechargeable battery        | EB900 | \$19.50   |
| Extended Warranty. 2/3 yrs extra. |       | \$40/\$55 |
| Mag Mnt Mobile Antenna. 15' coax. | MA100 | \$25.00   |
| Cigarette Lighter power adaptor.  | DC900 | \$14.00   |
| Extended Warranty. 2/3 yrs        |       | \$40/\$55 |

**Specifications:**

|              |   |
|--------------|---|
| Coverage:    | 27-54, 108-174, 406-512, 830-950MHz       |
| Sensitivity: | .4uV Lo,Hi. .8uV Air. .5uV UHF. 1.0uV 800 |
| Scan Speed:  | 15 ch/sec.                                |
| IF:          | 21.4MHz, 455KHz                           |
| Increments:  | 10,12.5,25,30                             |
| Audio:       | 200MW                                     |
| Power:       | 6VDC, 65MA                                |
| Antenna:     | BNC                                       |
| Display:     | LCD, backlighted                          |
| Dimensions:  | 5 3/4H x 2D x 1 1/2W. 12oz wt.            |

**AR2515**

**\$695**



**2016 Channels. 5-1500 MHz.**

**Standard Features:**

- Extremely compact size.
- Continuous coverage.
- 2016 channels permanent memory.
- AM, FM wide and narrow modes.
- Signal strength meter & Tuning Knob.
- Bank 1 Priority.
- 62 Scan Banks, 16 Search Banks.
- Telescopic antenna w/ BNC connector for >25MHz.
- AC & DC Power.
- One Year Limited Warranty.

**Options:**

|                                    |        |           |
|------------------------------------|--------|-----------|
| RS232 cable to DB25 connector.     | BW-1.  | \$24.95   |
| RS232 cable & software for MS DOS. | EG-1.  | \$39.95   |
| BFO for SSB listening.             | BFO-1. | \$159.00  |
| Base type antenna                  |        |           |
| 25 to 1000MHz w 50'coax.           | AS300  | \$59.95   |
| Mag Mnt Mobile Antenna. 15' coax.  | MA100  | \$25.00   |
| Cigarette Lighter power adaptor.   | CP100  | \$4.00    |
| External Speaker                   |        |           |
| with mobile mount.                 | MS100  | \$19.50   |
| Extended Warranty. 2/3 yrs         |        | \$30/\$45 |
| Mobile Mtng Bracket.               | MM1    | \$14.90   |
| Cigarette Lighter power adaptor.   | CP100  | \$4.00    |

**Specifications:**

|              |   |
|--------------|---|
| Coverage:    | 5 - 1500MHz                                 |
| Sensitivity: | .35uV NFM, 1.0uV WFM, 1.0uV AM >3.0uV SW AM |
| Scan Speed:  | <=36 ch/sec.                                |
| IF:          | 750MHz, 45.03MHz, 5.5MHz, 455MHz.           |
| Increments:  | 5,12.5,25KHz                                |
| Audio:       | 1W  |
| Power:       | 12VDC, 200MA                                |
| Antenna:     | BNC   |
| Display:     | LCD, backlighted                            |
| Dimensions:  | 3 1/7H x 7 7/8D x 5 2/5W. 2lb 10oz wt.      |

## To Order Call 1-800-445-7717

In All 50 States and Canada. 24 Hours a Day. Fax Orders: 1-800-448-1084, 24 Hours a Day.  
**ACE Communications Monitor Division 10707 E. 106th Street, Indianapolis, IN 46256**  
 Int'l Voice# 317-842-7115. Int'l Fax# 317-849-8794.

Service and Support Lines: Mon-Fri 9a.m. to 9p.m., Saturday 10-4. EST  
 MasterCard, Visa, American Express, Checks, Approved P.O.'s. & C.O.D. (add 5.00)  
*Prices and specifications subject to change.*

# KENWOOD

Pacesetter in Amateur Radio

**NEW**  
RZ-1 Wide-Band  
Receiver.

## Hear it All!



**R-5000**

**R-2000**  
High performance  
receivers.

Scan the world bands with Kenwood's R-5000, R-2000 and RZ-1. Listen in on foreign music, news, and commentary. Monitor local police, fire, and other public safety services, as well as the Marine channels, and the many other services 50 MHz and above.

(The VHF converter options must be used in the R-5000 and R-2000.)

### R-5000

The R-5000 is a high performance, top-of-the-line receiver, with 100 memory channels, and direct keyboard or main dial tuning—makes station selection



**R-2000**

The R-2000 is an all band, all mode receiver with 10 memory channels, and many deluxe features such as programmable scanning, dual 24-hour clocks with timer, all-mode squelch and noise blankers, a large, front-mounted speaker, 110 volt AC or 12 volt DC operation (with the DCK-1 cable kit), and 118-174 MHz VHF capability with VC-10 option.

### Optional Accessories R-2000:

- VC-10 VHF converter
- DCK-1 DC cable kit for 12 volt DC use.

### R-5000:

- VC-20 VHF converter
- VS-1 Voice module
- DCK-2 for 12 volt DC operation
- YK-88A-1 AM filter
- YK-88SN SSB filter
- YK-88C CW filter
- MB-430 Mounting bracket.

### Other Accessories:

- SP-430 External speaker
- SP-41 Compact mobile speaker
- SP-50B Mobile speaker
- HS-5 Deluxe headphones
- HS-6 Lightweight headphones

super easy! Other useful features include programmable scanning, large, built-in speaker, 110 volt AC or 12 volt DC operation (with optional DCK-2 cable), VHF capability (108-174 MHz) with the VC-20 option, dual 24-hour clocks with timer, and even voice frequency readout with the VS-1 option.

### RZ-1

Wide-band scanning receiver



The RZ-1 wide-band, scanning receiver covers 500 kHz-905 MHz, in AM, and narrow or wideband FM. The automatic mode selection function makes listening

easier. One hundred memory channels with message and band marker, direct keyboard or VFO frequency entry, and versatile scanning functions, such as memory channel and band scan, with four types of scan stop. The RZ-1 is a 12 volt DC operated, compact unit, with built-in speaker, front-mounted phones jack, switchable AGC, squelch for narrow FM, illuminated keys, and a "beeper" to confirm keyboard operation.

- Optional Accessory**
- PG-2N Extra DC cable

# KENWOOD

CIRCLE 109 ON READER SERVICE CARD

KENWOOD U.S.A. CORPORATION  
COMMUNICATIONS & TEST EQUIPMENT GROUP  
P.O. BOX 22745, 2201 E. Dominguez Street  
Long Beach, CA 90801-5745

KENWOOD ELECTRONICS CANADA INC.  
P.O. BOX 1075, 959 Gana Court  
Mississauga, Ontario, Canada L4T 4C2